

# **A ALTEST**<sup>®</sup>

ALUMINIUM PROFILES SYSTEMS

## **PONY**





**ALTEST**®  
**Ltd.**

## **ATTENTION!**

For faultless operation, please read carefully this catalogue!

It was elaborated by ALTEST Company. Its copying, reproduction, and reprinting without our consent is not welcomed!

The profiles presented in the catalogue are patented and ALTEST Company has the exclusive rights. ALTEST Company reserves that right to modify the profiles and the presented sections at its own discretion. The system is equipped with full set of calculations made in accordance with the existing manufacturing requirements, presented in this catalogue.

In conclusion - use original ALTEST profiles in compliance with the peculiarities and the technical characteristics presented in this catalogue.

**CONTENTS:**

- 1. PROFILES OVERVIEW**
- 2. ACCESSORIES**
- 3. PROFILES**
- 4. SECTIONS**
- 5. CUTTING ANALYSIS**
- 6. 3D DETAILS**

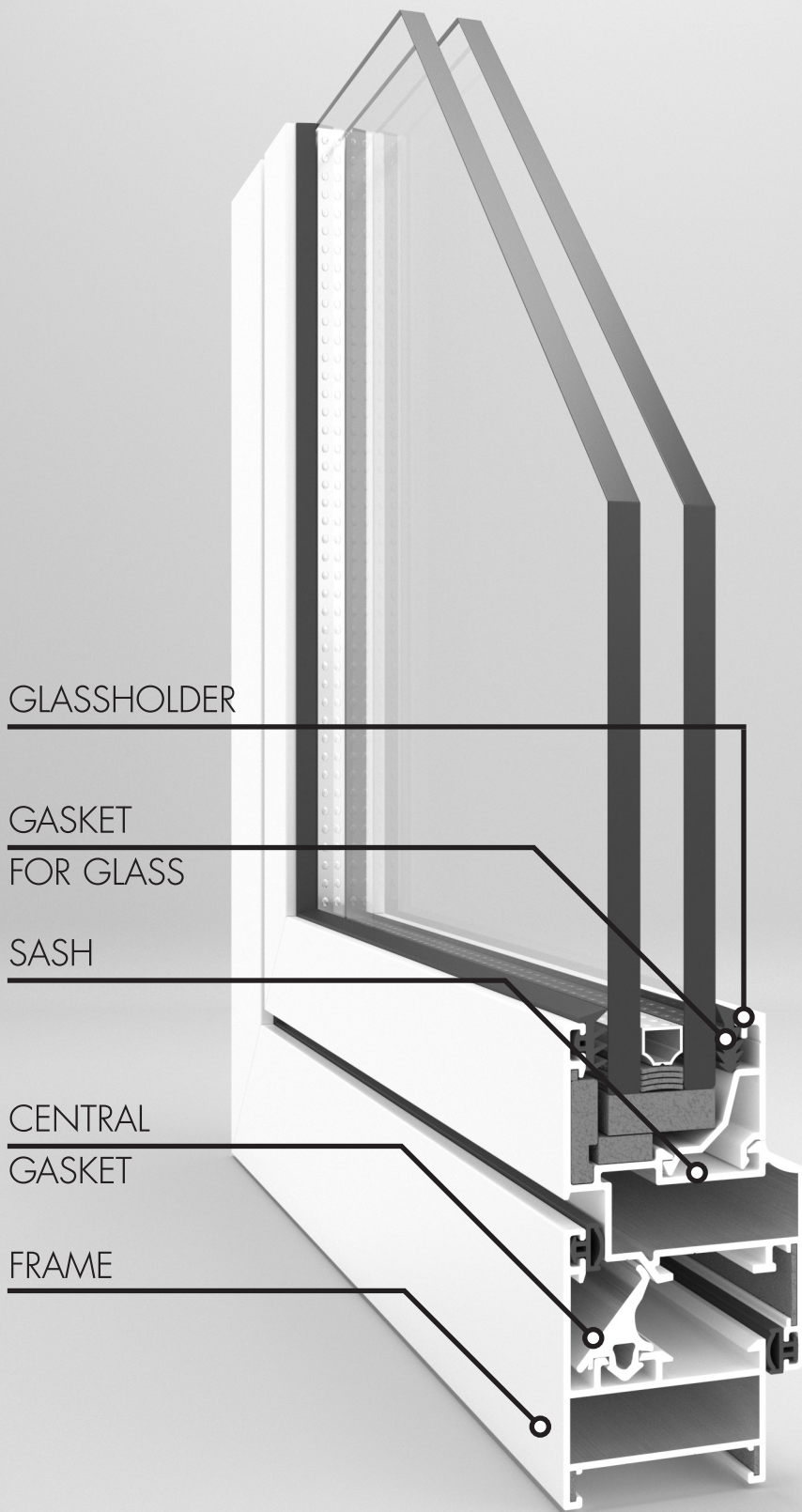

GLASSHOLDER

GASKET  
FOR GLASS

SASH

CENTRAL  
GASKET

FRAME

## INTRODUCTION

The "PONY" system of company ALTEST is 37,5mm aluminium series designed according to European standards and comfortable to requirements and dimensions of the hardware- hinges,locks and etc.

The „PONY" system is suitable for different version of opening and fixed systems. The range of profiles,modern accessories and EPDM gaskets guarantee perfect draining and faultless performance in different situations. The series is suitable also for tilt and turn mechanism.Versions of fixed,vertical and horizontal opening windows as well as fixed and opening sections doors are possible.

The „PONY" system is based on work with three seal gaskets-central, outer and inner(the central gasket is specially designed for the series). The dimensions of the hardware channel are designed according to the European Standard and in this way it provides trouble-free use of hardware and joints.The wide range of basic profiles and glass holders,allows the usage of single(4-10 mm) pane and 20 or 24 mm glazing.

Variable design elaboratons are possible, due to wide the variety of frames,sashes and other auxiliary profiles.

ALTEST company offers wide range of surface treatments : sublimation, powder coating ,anodizing and lamination.

„PONY" series are extruded from the following alloys: EN AW-6060 (Al Mg Si) and EN AW 6063 (Al Mg0,7 Si).

The properties of alloy EN AW-6063 are:

- \*Ultimate tensile strength-  $R_m = 210 \text{ N/m}^2$
- \*Yield strength-  $R_{p0,2} = 160 \text{ N/m}^2$
- \*Modulus of elasticity-  $E_{al} = 70\,000 \text{ N/mm}^2 = 7 \cdot 10^9 \text{ kg/m}^2$
- \*Coefficient of thermal expansion:  $\alpha = 0.023 \text{ mm/m} \cdot \text{K}$  (up to 1.2 mm/m for difference up to 50 °)

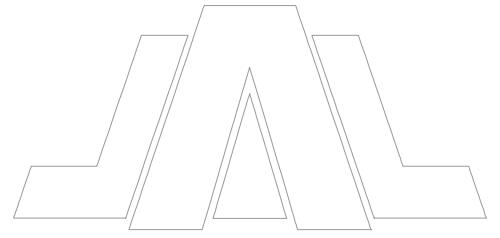

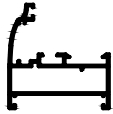
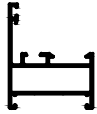
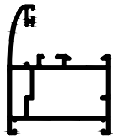
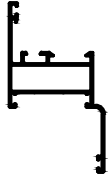
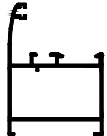
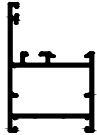
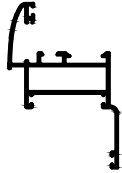
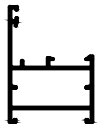
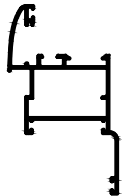

# ***PROFILES OVERVIEW***

**PROFILES OVERVIEW**

Profile shape	Profile code / description	Weight (gr/m)	Profile shape	Profile code / description	Weight (gr/m)
	375 0004 frame new *	322		375 0020 frame	668
	375 0005 frame	580		375 0035 frame	819
	375 0006 frame	702		375 0036 frame	687
	375 0010 frame	665		375 0040 frame	758
	375 0011 frame	560		375 0045 frame	841

WARNING: ALL OF THE PROFILE WEIGHTS ARE THEORETICAL.

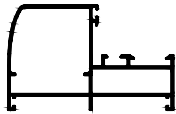
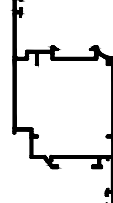
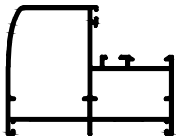
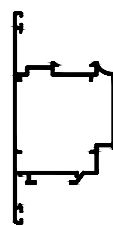

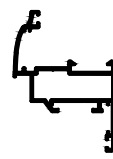
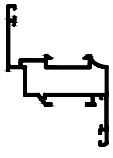
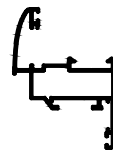
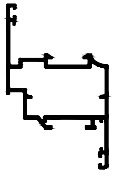
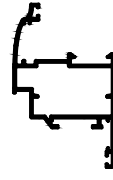
**PROFILES OVERVIEW**

Profile shape	Profile code / description	Weight (gr/m)	Profile shape	Profile code / description	Weight (gr/m)
	375 0050 frame	957		375 0115 sash	965
	375 0055 frame	1072		375 0120 sash	954
	375 0405 frame	434		375 0125 sash	705
	375 0105 sash	694		375 0126 sash	716
	375 0110 sash	797		375 0130 sash	815

WARNING: ALL OF THE PROFILE WEIGHTS ARE THEORETICAL.

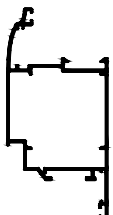
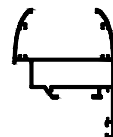
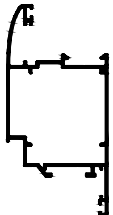
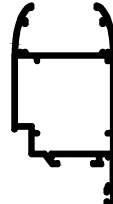
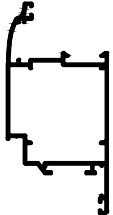

**PROFILES OVERVIEW**

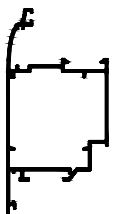
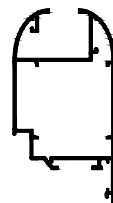
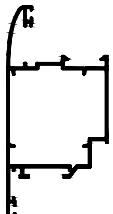
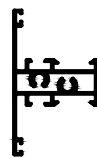
Profile shape	Profile code / description	Weight (gr/m)	Profile shape	Profile code / description	Weight (gr/m)
	375 0135 sash	940		375 0145 sash	722
	375 0136 sash	987		375 0155 sash	995
	375 0138 sash	897		375 0160 sash	800
	375 0140 sash	970		375 0170 sash	1064
	375 0141 sash	977		375 0205 mullion	840





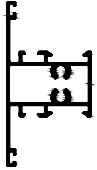
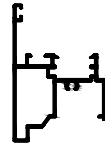
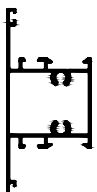
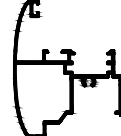
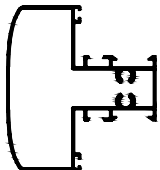
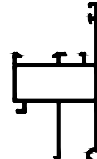
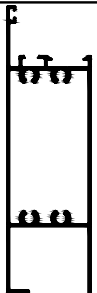
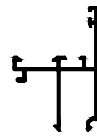
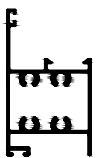
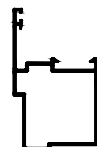



WARNING: ALL OF THE PROFILE WEIGHTS ARE THEORETICAL.

## PROFILES OVERVIEW

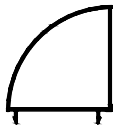
Profile shape	Profile code / description	Weight (gr/m)	Profile shape	Profile code / description	Weight (gr/m)
	375 0210 mullion	882		375 0305 overhung	738
	375 0215 mullion	954		375 0310 overhung	794
	375 0235 mullion	1192		375 0315 outer opening profile	758
	375 0225 door board	1482		375 0320 outer opening profile	542
	375 0226 door board	970		375 0325 addition for door	638

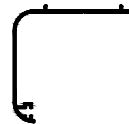
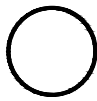









WARNING: ALL OF THE PROFILE WEIGHTS ARE THEORETICAL.

## PROFILES OVERVIEW

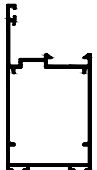
Profile shape	Profile code / description	Weight (gr/m)	Profile shape	Profile code / description	Weight (gr/m)
	375 0330 column for 90° angle	520		375 0345-1 addition for pipe	315
	375 0330-1 column for 90° angle	615		375 0350 decoration profile	225
	375 0335 column for 135° angle	400		375 0350-1 edge	385
	375 0340 pipe	428		375 0355 decoration profile	123
	375 0345 addition for pipe	279		375 0360 addition for door	255





WARNING: ALL OF THE PROFILE WEIGHTS ARE THEORETICAL.

**PROFILES OVERVIEW**

Profile shape	Profile code / description	Weight (gr/m)	Profile shape	Profile code / description	Weight (gr/m)
	375 0361 addition for door	488		375 0520 glass bead for 4 mm glass	268
	375 0365 door sill	379		375 0530 glass bead for 8 mm glass	260
	375 0410 two-sides sash	783		375 0550 glass bead for 24 mm glass	203
	375 0415 two-sides addition	395		1017 glass bead for 20 mm glass	222
	375 0510 glass bead for 0 mm glass	290		1200 glass bead for 4 mm glass	270

WARNING: ALL OF THE PROFILE WEIGHTS ARE THEORETICAL.

**PROFILES OVERVIEW**

Profile shape	Profile code / description	Weight (gr/m)	Profile shape	Profile code / description	Weight (gr/m)
	9312 glass bead for 10 mm glass	235			
	9316 espagnolette	152			
	9317 profile larmier	106			
	1852 aluminium panel	326			
	9358 aluminium panel	804			

WARNING: ALL OF THE PROFILE WEIGHTS ARE THEORETICAL.

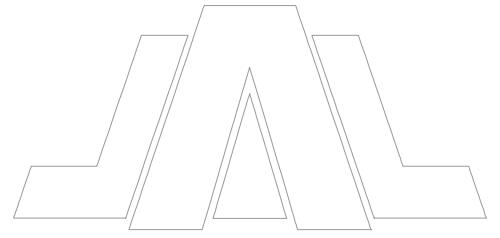

# ***ACCESSORIES***

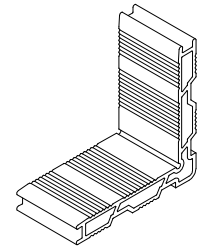

APE 1030/1031

Press corner

---

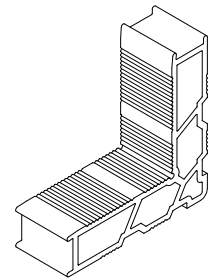

APE 2070

Press corner

---

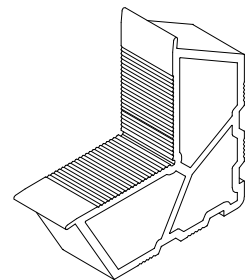

APE 4180

Press corner

---

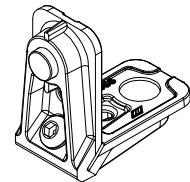

APE 3

Mechanical corner

---

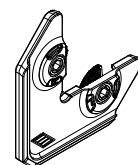

APE 10

Mechanical corner

---

APE 7

Alignment corner

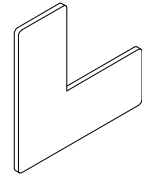

APE 6

Alignment corner

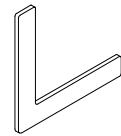

BA2870

big GABI joint

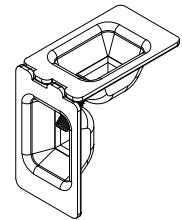

BA1001

P100.1 joint

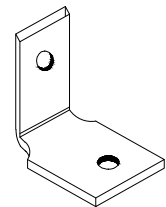



U00;0;1;1.5;2;2.5;3;4;5;

EPDM gasket for glazing

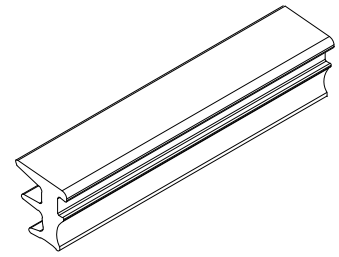

U60

gasket for the opening parts

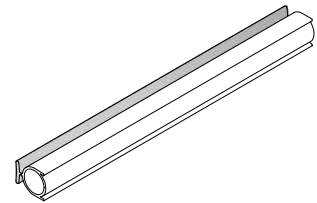

U68

gasket for the fix parts

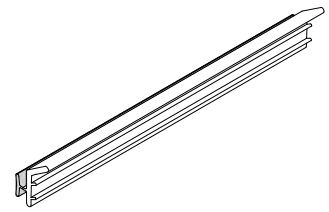

US68

EPDM gasket for the fix parts

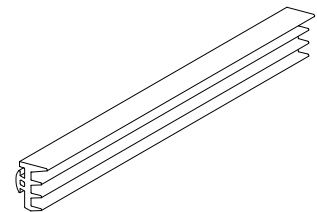

US60

EPDM gasket for the opening parts

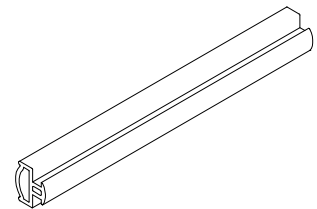

UG6168

EPDM central gasket

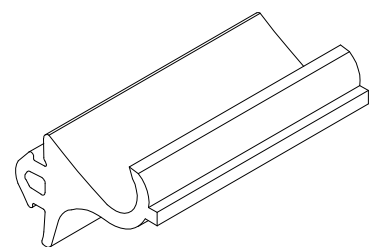

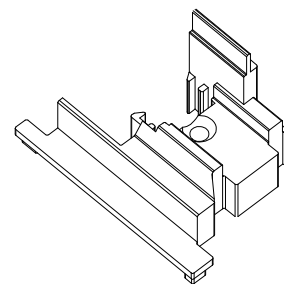

APE211

Cover cap for overhung 375 0305

---

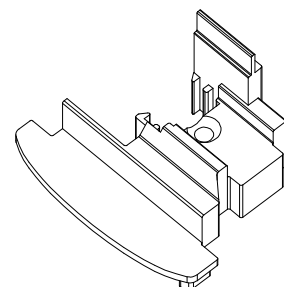

APE200

Cover cap for overhung 375 0310

---

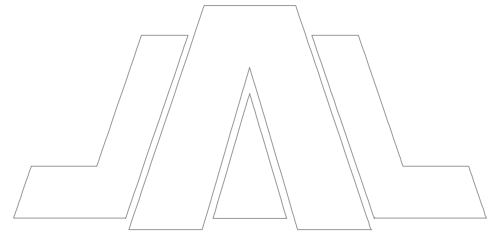

# ***PROFILES***

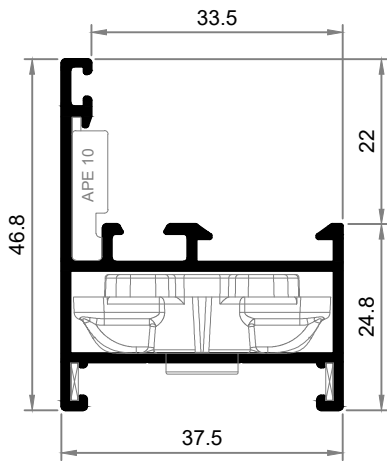

375 0005 Frame		Weight (gr/m)	$I_x / I_y$ (cm <sup>4</sup> )	$W_x / W_y$ (cm <sup>3</sup> )
		580	2.85/4.18	0.99/1.88
JOINTS	APE 1030               APE 6               APE 10               APE 3			
	GASKETS	U 00.0;1;1.5; 2;2.5;3;4;5               U 60 U 68     US 68     US 60     UG 6168		

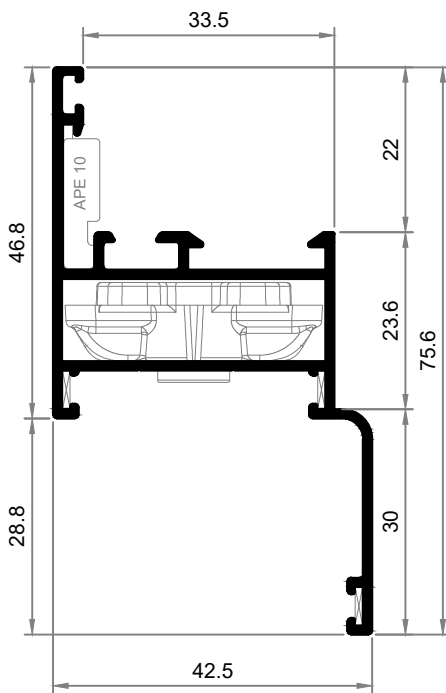

375 0006 Frame		Weight (gr/m)	$I_x / I_y$ (cm <sup>4</sup> )	$W_x / W_y$ (cm <sup>3</sup> )
		702	7.23/6.74	1.76/2.98
JOINTS	APE 1030               APE 6               APE 10               APE 3			
	GASKETS	U 00.0;1;1.5; 2;2.5;3;4;5               U 60 U 68     US 68     US 60     UG 6168		

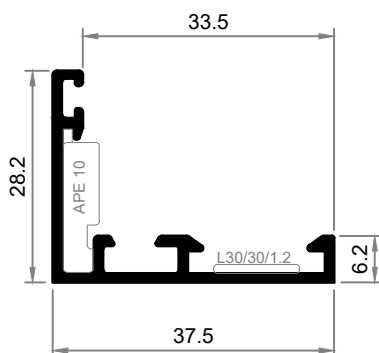

375 0004 Frame new*		Weight (gr/m)	$I_x / I_y$ (cm <sup>4</sup> )	$W_x / W_y$ (cm <sup>3</sup> )
		322	0,89/1,86	0,43/0,74
JOINTS	APE 10               L 30/30/1.2 0205		GASKETS	U3 US 68

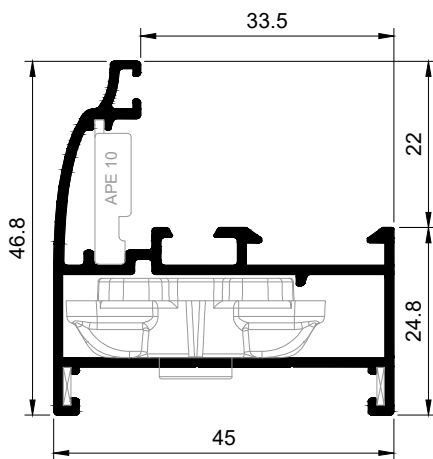
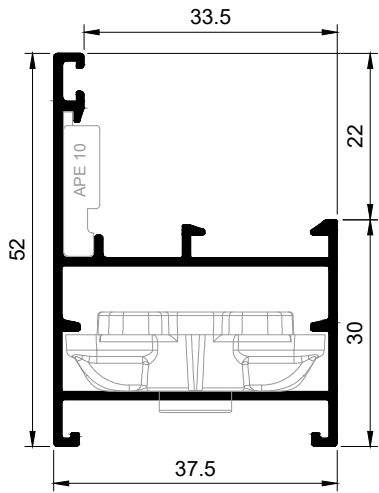
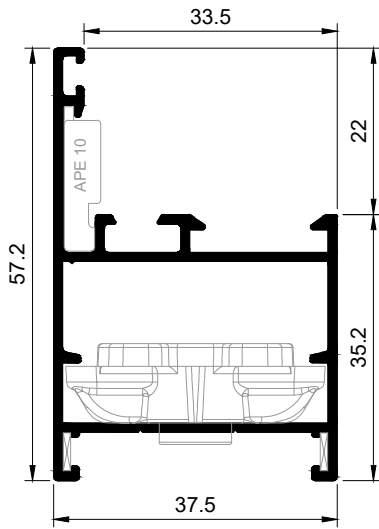

375 0010 Frame		Weight (gr/m)	$I_x / I_y$ (cm <sup>4</sup> )	$W_x / W_y$ (cm <sup>3</sup> )
		665	5.50/5.20	1.63/2.39
JOINTS	APE 2070                  APE 6                  APE 10                  APE 3			
	GASKETS:  U 00.0;1;1.5;2;2.5;3;4;5                  U 60                  U 68                  US 68                  US 60                  UG 6168			

375 0011 Frame		Weight (gr/m)	$I_x / I_y$ (cm <sup>4</sup> )	$W_x / W_y$ (cm <sup>3</sup> )
		560	3.77/4.42	1.20/2.03
JOINTS	APE 10                  APE 3			
	GASKETS:  U 00.0;1;1.5;2;2.5;3;4;5                  U 60                  U 68                  US 68                  US 60			

375 0020 Frame		Weight (gr/m)	$I_x / I_y$ (cm <sup>4</sup> )	$W_x / W_y$ (cm <sup>3</sup> )
		668	3.31/6.23	1.15/2.41
JOINTS	APE 1031                  APE 6                  APE 10                  APE 3			
	GASKETS:  U 00.0;1;1.5;2;2.5;3;4;5                  U 60                  U 68                  US 68                  US 60                  UG 6168			

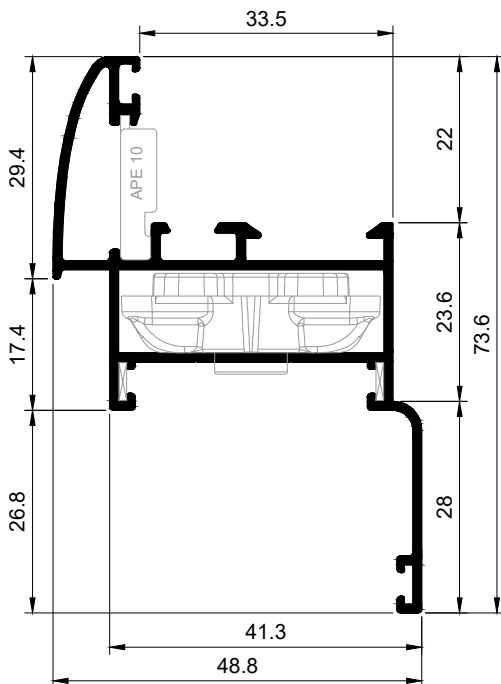
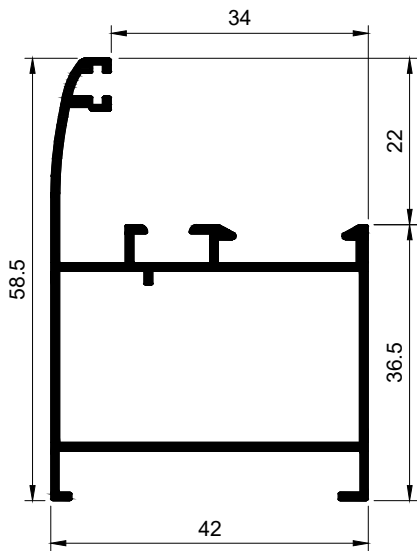
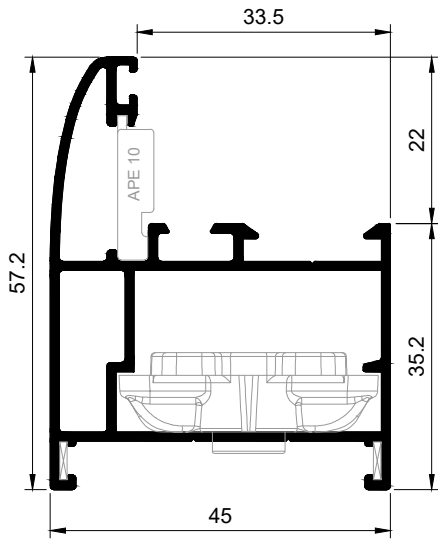

375 0035 Frame		Weight (gr/m)	$I_x / I_y$ (cm <sup>4</sup> )	$W_x / W_y$ (cm <sup>3</sup> )
		816	7.00/7.81	2.10/2.96
JOINTS				
	<p>APE 2070    APE 6    APE 10    APE 3</p>			
GASKETS				
	<p>U 68    US 68    US 60    UG 6168</p>			

375 0036 Frame		Weight (gr/m)	$I_x / I_y$ (cm <sup>4</sup> )	$W_x / W_y$ (cm <sup>3</sup> )
		687	6.22/6.41	1.86/2.69
JOINTS				
	<p>BA 2870</p>			
GASKETS				
	<p>U 68    US 68    US 60    UG 6168</p>			

375 0040 Frame		Weight (gr/m)	$I_x / I_y$ (cm <sup>4</sup> )	$W_x / W_y$ (cm <sup>3</sup> )
		758	7.80/8.13	1.91/3.32
JOINTS				
	<p>APE 1030    APE 6    APE 10    APE 3</p>			
GASKETS				
	<p>U 68    US 68    US 60    UG 6168</p>			

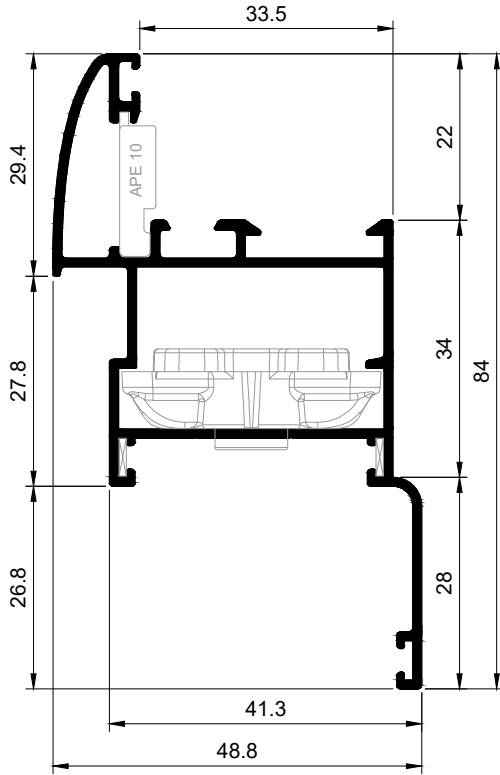

<b>375 0045</b> Frame	Weight (gr/m)	$I_x / I_y$ (cm <sup>4</sup> )	$W_x / W_y$ (cm <sup>3</sup> )
	841	12.39/9.00	2.66/3.63
<b>JOINTS</b>	APE 2070	APE 6	APE 10
			APE 3
<b>GASKETS</b>	U 00.0;1;1.5; 2;2.5;3;4;5          U 60		
	U 68	US 68	US 60
			UG 6168

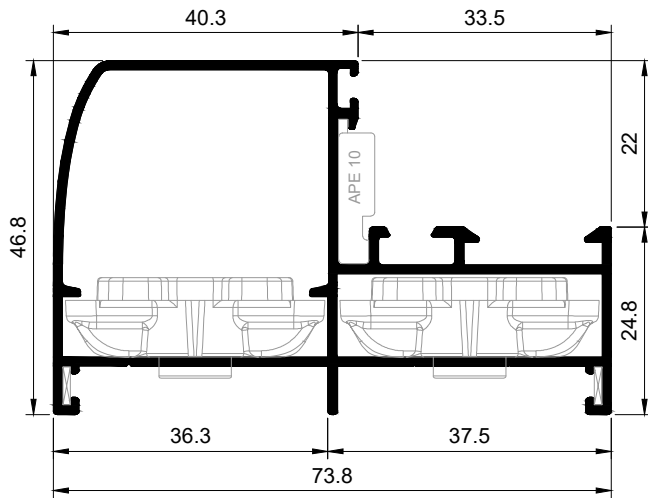

<b>375 0050</b> Frame	Weight (gr/m)	$I_x / I_y$ (cm <sup>4</sup> )	$W_x / W_y$ (cm <sup>3</sup> )
	957	7.22/19.77	2.70/5.19
<b>JOINTS</b>	APE 1030	APE 6	APE 10
			APE 3
<b>GASKETS</b>	U 00.0;1;1.5; 2;2.5;3;4;5          U 60		
	U 68	US 68	US 60
			UG 6168

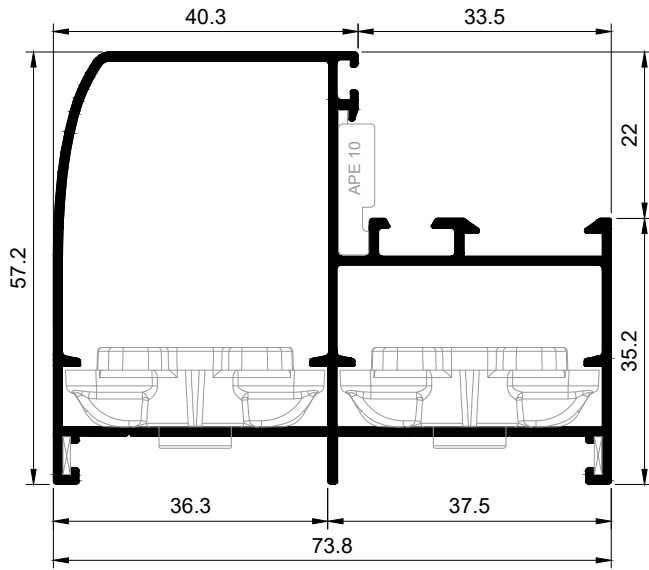

375 0055 Frame		Weight (gr/m)	$I_x / I_y$ (cm <sup>4</sup> )	$W_x / W_y$ (cm <sup>3</sup> )
		1072	12.50/23.44	3.92/6.22
JOINTS				
	APE 2070	APE 6	APE 10	APE 3
GASKETS				
	U 00.0;1;1.5;2;2.5;3;4;5	U 60	U 68	US 68
	US 60	UG 6168		

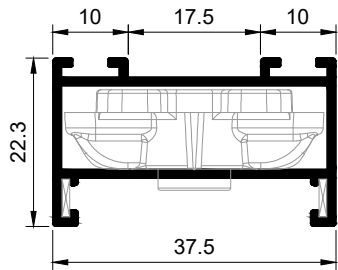

375 0405 Frame		Weight (gr/m)	$I_x / I_y$ (cm <sup>4</sup> )	$W_x / W_y$ (cm <sup>3</sup> )
		434	0.76/3.06	0.61/1.63
JOINTS				
	APE 1030	APE 6	APE 3	
BRUSHES				
	TZ 12			

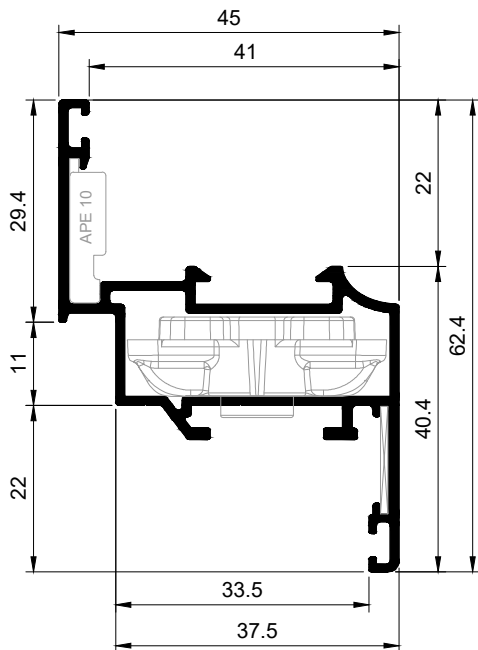

375 0105 Sash		Weight (gr/m)	$I_x / I_y$ (cm <sup>4</sup> )	$W_x / W_y$ (cm <sup>3</sup> )
		694	4.75/6.90	1.48/2.95
JOINTS				
	APE 1030	APE 7	APE 10	APE 3
GASKETS				
	U 00.0;1;1.5;2;2.5;3;4;5	U 60	U 68	US 68
	US 60			



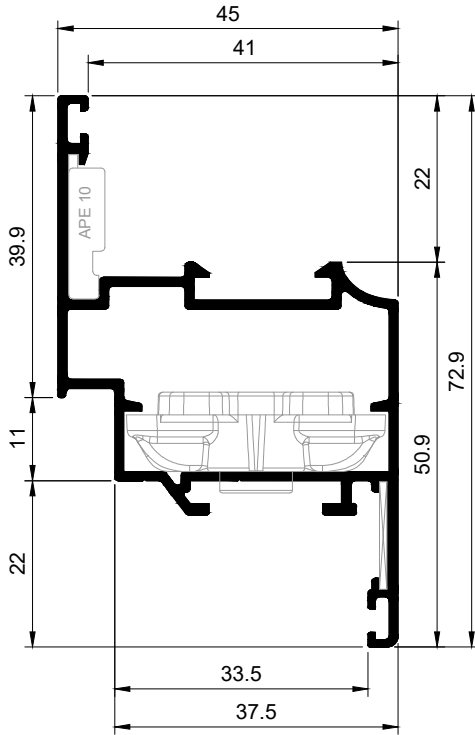

375 0110 Sash		Weight (gr/m)	$I_x / I_y$ (cm <sup>4</sup> )	$W_x / W_y$ (cm <sup>3</sup> )	
		797	8.44/8.53	2.26/3.71	
JOINTS					
	APE 2070	APE 7	APE 10	APE 3	
GASKETS					
	U 00.0;1;1.5;2;2.5;3;4;5	U 60	U 68	US 68	US 60

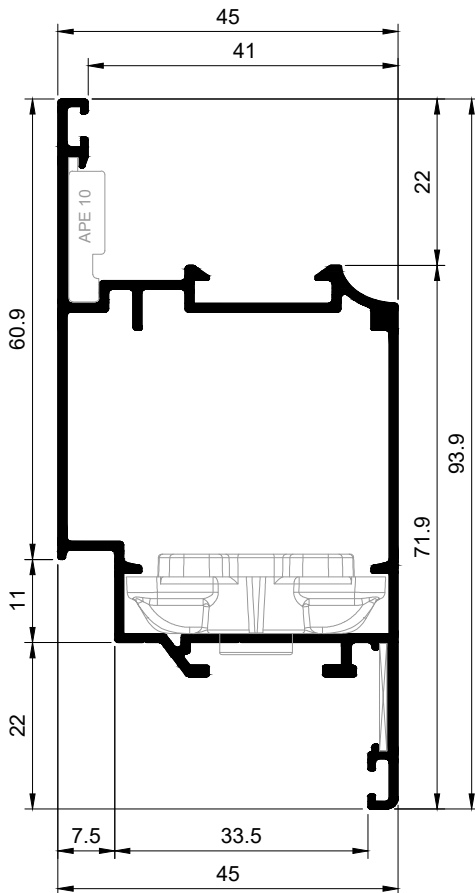

375 0115 Sash		Weight (gr/m)	$I_x / I_y$ (cm <sup>4</sup> )	$W_x / W_y$ (cm <sup>3</sup> )	
		965	21.13/11.26	4.47/4.90	
JOINTS					
	APE 4180	APE 7	APE 10	APE 3	
GASKETS					
	U 00.0;1;1.5;2;2.5;3;4;5	U 60	U 68	US 68	US 60

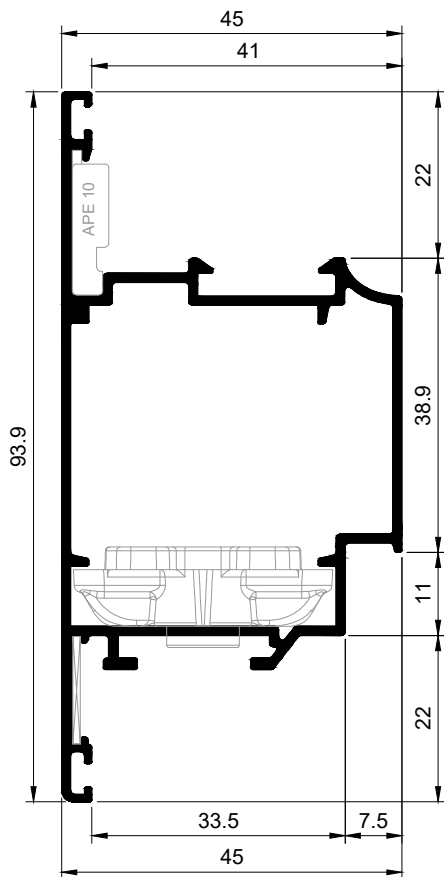

375 0120 Sash		Weight (gr/m)	$I_x / I_y$ (cm <sup>4</sup> )	$W_x / W_y$ (cm <sup>3</sup> )
		954	20.95/10.07	4.41/3.58
JOINTS				
	APE 4180	APE 7	APE 10	APE 3
GASKETS				

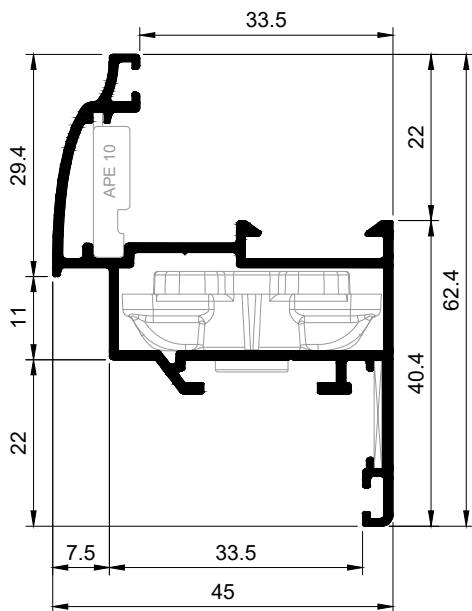

375 0125 Sash		Weight (gr/m)	$I_x / I_y$ (cm <sup>4</sup> )	$W_x / W_y$ (cm <sup>3</sup> )
		705	5.13/6.65	1.62/2.76
JOINTS				
	APE 1030	APE 7	APE 10	APE 3
GASKETS				

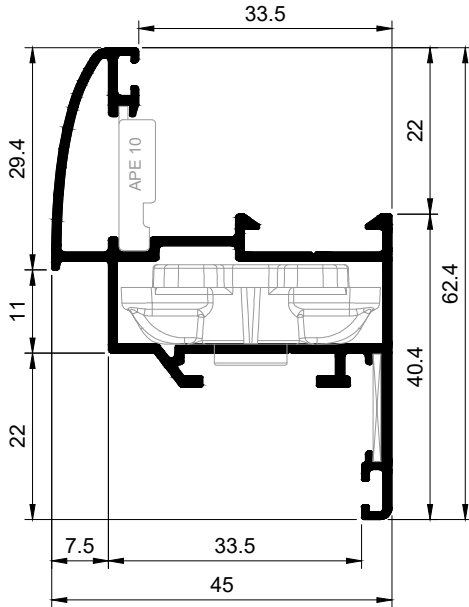

375 0126 Sash		Weight (gr/m)	$I_x / I_y$ (cm <sup>4</sup> )	$W_x / W_y$ (cm <sup>3</sup> )
		716	5.63/6.72	1.80/2.81
JOINTS				
	APE 1030	APE 7	APE 10	APE 3
GASKETS				

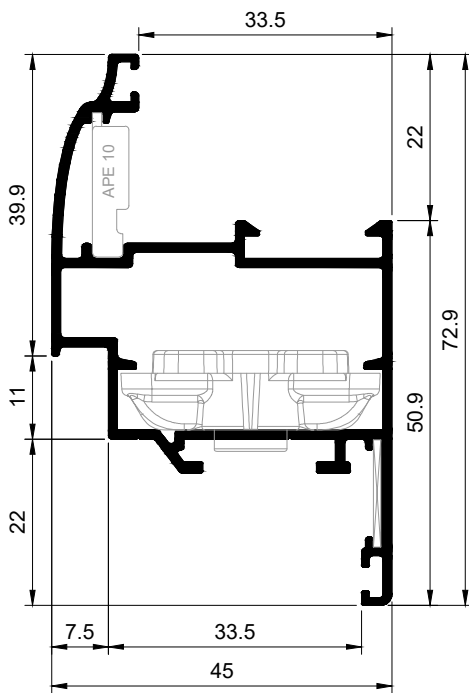

375 0130 Sash		Weight (gr/m)	$I_x / I_y$ (cm <sup>4</sup> )	$W_x / W_y$ (cm <sup>3</sup> )
		815	8.98/8.36	2.44/3.57
JOINTS				
	APE 2070	APE 7	APE 10	APE 3
GASKETS				

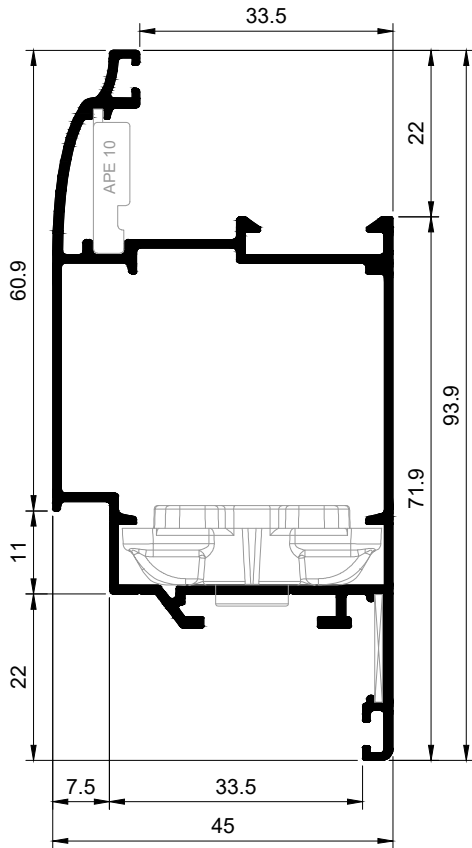

375 0135 Sash		Weight (gr/m)	$I_x / I_y$ (cm <sup>4</sup> )	$W_x / W_y$ (cm <sup>3</sup> )
		940	21.55/10.65	4.59/4.57
JOINTS				
	APE 4180	APE 7	APE 10	APE 3
GASKETS	U 00.0;1;1.5; 2;2.5;3;4;5                  U 60                  U 68                  US 68                  US 60			

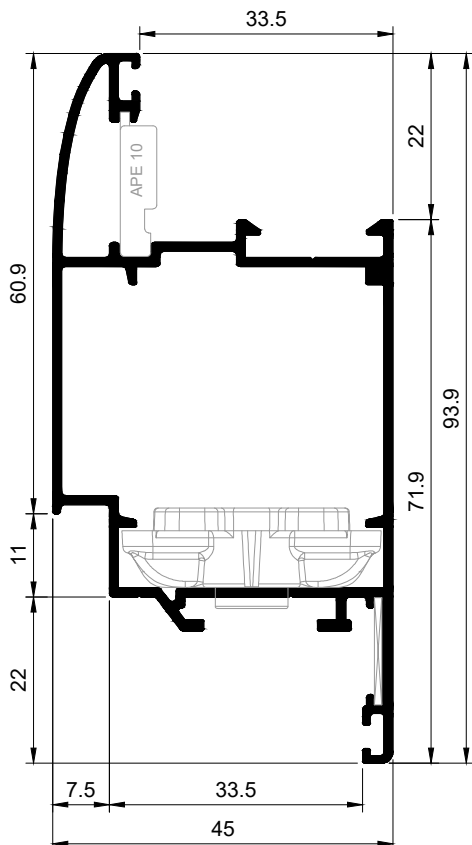

375 0136 Sash		Weight (gr/m)	$I_x / I_y$ (cm <sup>4</sup> )	$W_x / W_y$ (cm <sup>3</sup> )
		987	23.08/11.11	4.86/4.77
JOINTS				
	APE 4180	APE 7	APE 10	APE 3
GASKETS	U 00.0;1;1.5; 2;2.5;3;4;5                  U 60                  U 68                  US 68                  US 60			

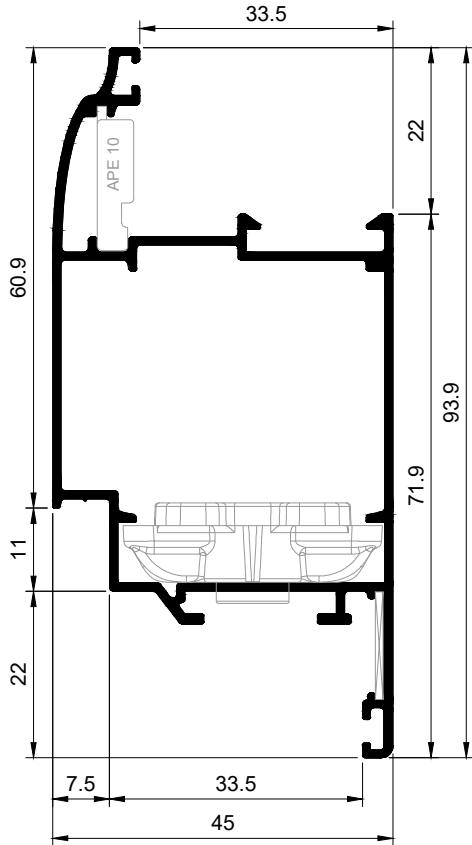

375 0138 Sash		Weight (gr/m)	$I_x / I_y$ (cm <sup>4</sup> )	$W_x / W_y$ (cm <sup>3</sup> )
		897	20.80/10.20	4.41/4.38
JOINTS				
	<p>APE 4180      APE 7      APE 10      APE 3</p>			
GASKETS				
	<p>U 00.0;1;1.5;2;2.5;3;4;5      U 60      U 68      US 68      US 60</p>			

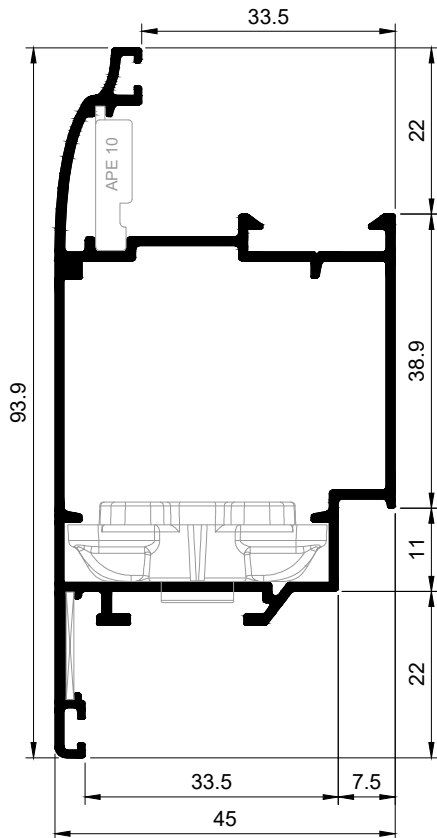

375 0140 Sash		Weight (gr/m)	$I_x / I_y$ (cm <sup>4</sup> )	$W_x / W_y$ (cm <sup>3</sup> )
		970	21.93/10.07	4.67/3.64
JOINTS				
	<p>APE 4180      APE 7      APE 10      APE 3</p>			
GASKETS				
	<p>U 00.0;1;1.5;2;2.5;3;4;5      U 60      U 68      US 68      US 60</p>			

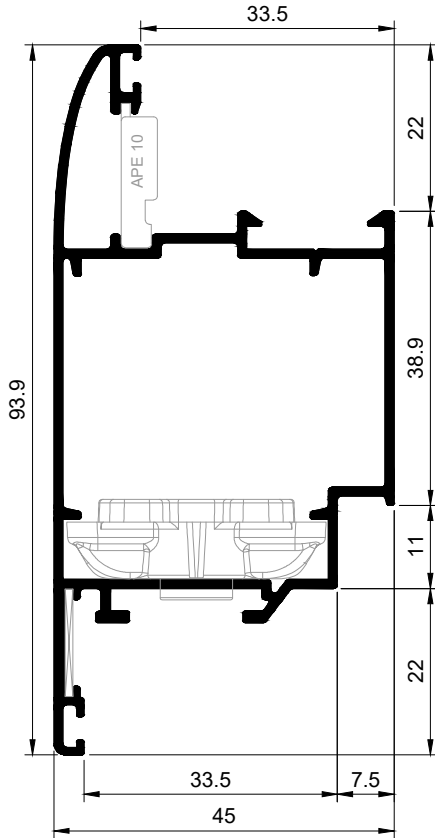

375 0141 Sash		Weight (gr/m)	$I_x / I_y$ (cm <sup>4</sup> )	$W_x / W_y$ (cm <sup>3</sup> )
		977	22.99/10.05	4.85/3.63
JOINTS	APE 4180                  APE 7                  APE 10                  APE 3			
	GASKETS	U 00.0;1;1.5;2;2.5;3;4;5                  U 60                  U 68                  US 68                  US 60		

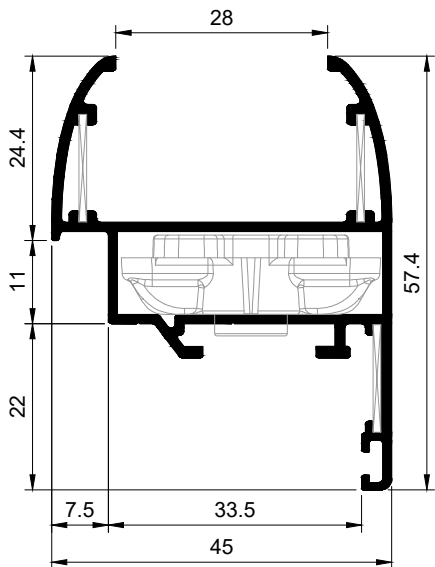

375 0145 Sash		Weight (gr/m)	$I_x / I_y$ (cm <sup>4</sup> )	$W_x / W_y$ (cm <sup>3</sup> )
		722	4.95/7.04	1.60/2.62
JOINTS	APE 1030                  APE 7                  APE 3			
	GASKETS	U 00.0;1;1.5;2;2.5;3;4;5                  U 60                  U 68                  US 68                  US 60		

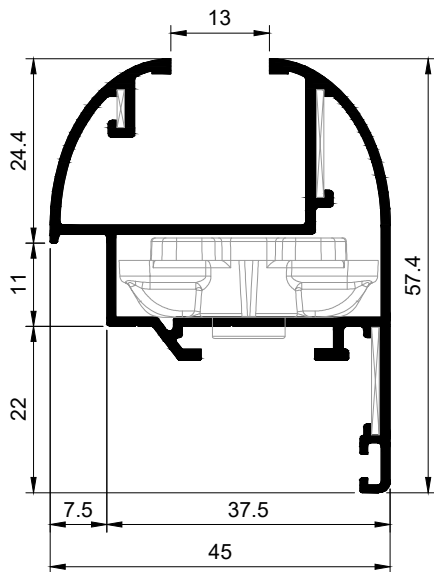
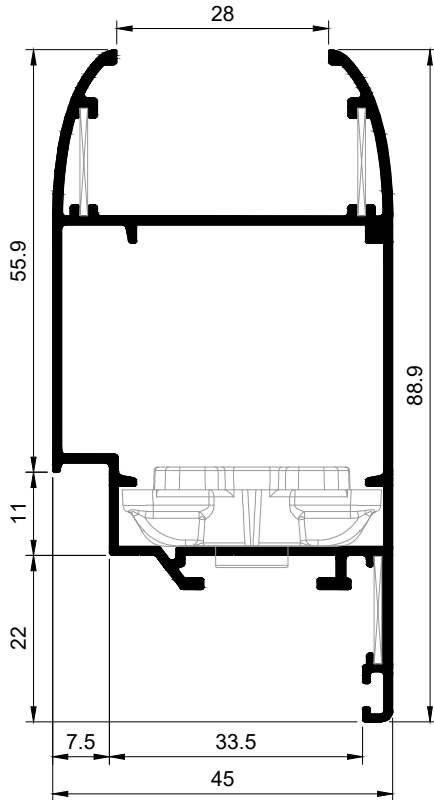

375 0155 Sash		Weight (gr/m)	$I_x / I_y$ (cm <sup>4</sup> )	$W_x / W_y$ (cm <sup>3</sup> )
		995	22.15/11.57	4.67/4.54
JOINTS				
	APE 4180	APE 7	APE 3	
GASKETS				
	U 00.0;1;1.5; 2;2.5;3;4;5	U 60	U 68	US 68 US 60

375 0160 Sash		Weight (gr/m)	$I_x / I_y$ (cm <sup>4</sup> )	$W_x / W_y$ (cm <sup>3</sup> )
		800	6.31/6.68	1.89/2.54
JOINTS				
	APE 1030	APE 6	APE 7	APE 3
GASKETS				
	U 00.0;1;1.5; 2;2.5;3;4;5	U 60	U 68	US 68 US 60

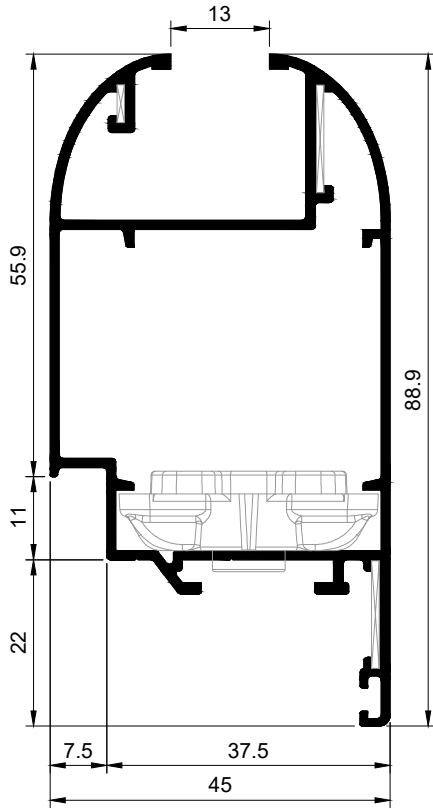

<b>375 0170</b> Sash		Weight (gr/m)	$I_x / I_y$ (cm <sup>4</sup> )	$W_x / W_y$ (cm <sup>3</sup> )
		1064	26.17/11.12	5.20/4.41
JOINTS				

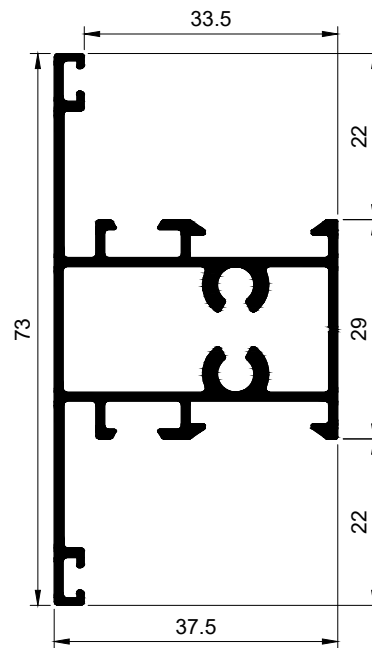
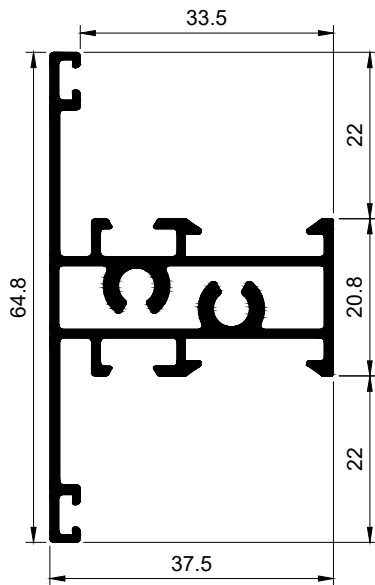

<b>375 0205</b> Mullion		Weight (gr/m)	$I_x / I_y$ (cm <sup>4</sup> )	$W_x / W_y$ (cm <sup>3</sup> )
		840	4.88/4.81	1.51/2.05
JOINTS				

<b>375 0210</b> Mullion		Weight (gr/m)	$I_x / I_y$ (cm <sup>4</sup> )	$W_x / W_y$ (cm <sup>3</sup> )
		882	7.72/5.67	2.12/2.54
JOINTS				



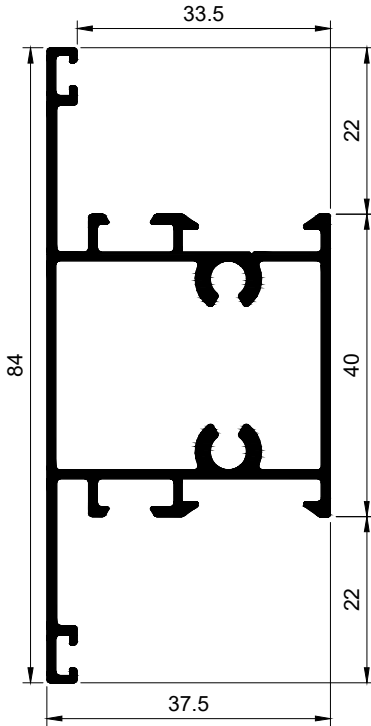



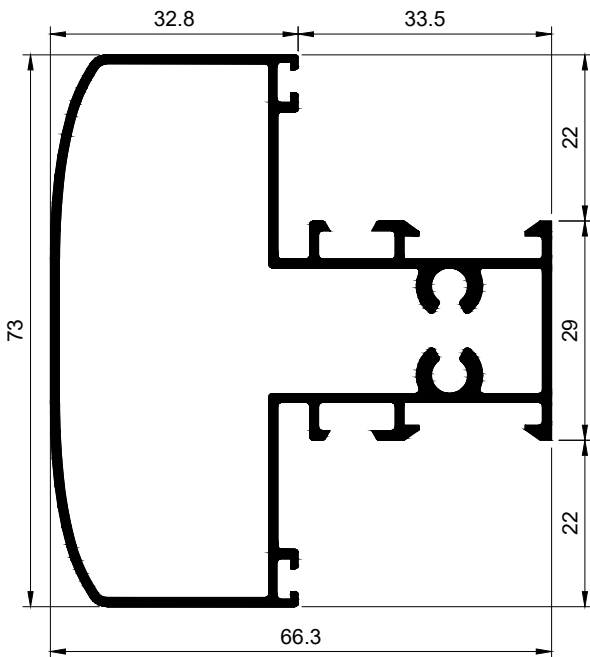

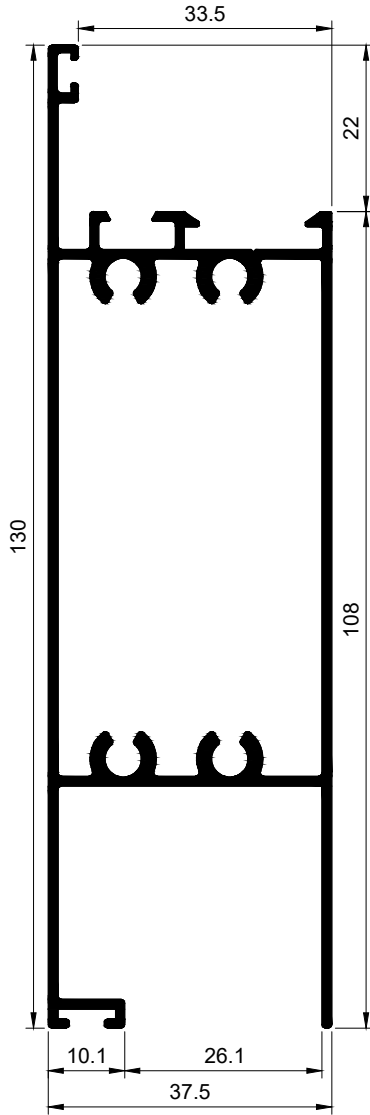

<b>375 0215</b> Mullion	Weight (gr/m)	$I_x / I_y$ (cm <sup>4</sup> )	$W_x / W_y$ (cm <sup>3</sup> )
	954	13.23/6.57	3.15/2.97
JOINTS	BA 1001       VM 12212		
GASKETS	U 00.0;1;1.5; 2;2.5;3;4;5       U 60       U 68 US 68       US 60		



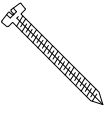



<b>375 0235</b> Mullion	Weight (gr/m)	$I_x / I_y$ (cm <sup>4</sup> )	$W_x / W_y$ (cm <sup>3</sup> )
	1192	18.23/19.69	4.99/5.93
JOINTS	BA 1001       VM 12212		
GASKETS	U 00.0;1;1.5; 2;2.5;3;4;5       U 60       U 68 US 68       US 60		

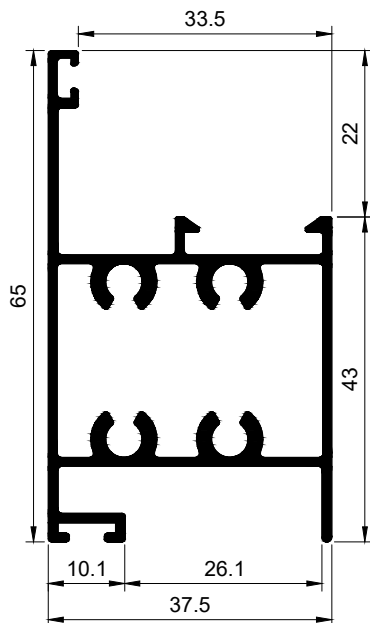

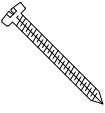
<b>375 0225</b> Door board	Weight (gr/m)	$I_x / I_y$ (cm <sup>4</sup> )	$W_x / W_y$ (cm <sup>3</sup> )
	1482	73.69/12.14	11.10/5.84
JOINTS	  BA 1001      VM 12212		
GASKETS	   U 00.0;1;1.5;2;2.5;3;4;5      U 68      US 68		
BRUSHES	 TZ 12;TZ18;		



<b>375 0226</b> Door board	Weight (gr/m)	$I_x / I_y$ (cm <sup>4</sup> )	$W_x / W_y$ (cm <sup>3</sup> )
	970	9.14/6.20	2.34/2.87
JOINTS	  BA 1001      VM 12212		
GASKETS	   U 00.0;1;1.5;2;2.5;3;4;5      U 68      US 68		
BRUSHES	 TZ 12;TZ18;		

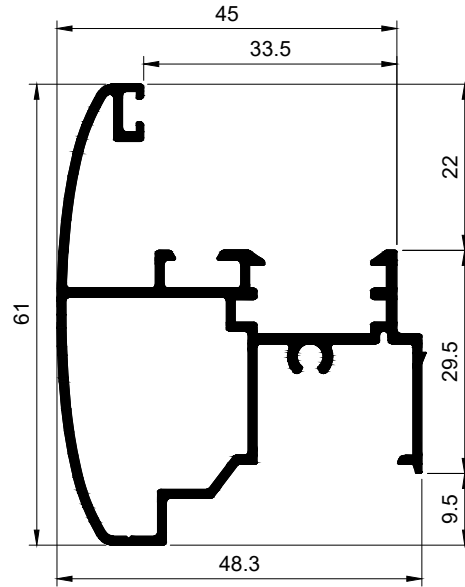
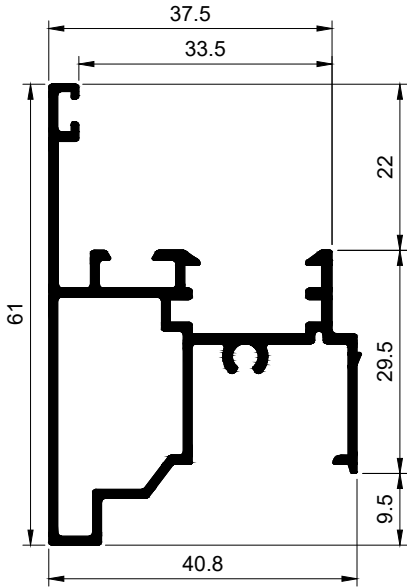

375 0305 Overhung	Weight (gr/m)	$I_x / I_y$ (cm <sup>4</sup> )	$W_x / W_y$ (cm <sup>3</sup> )
	738	5.49/5.41	1.62/2.11

375 0310 Overhung	Weight (gr/m)	$I_x / I_y$ (cm <sup>4</sup> )	$W_x / W_y$ (cm <sup>3</sup> )
	794	6.59/7.38	2.00/2.61

COVER CAP			
GASKETS			

COVER CAP			
GASKETS			

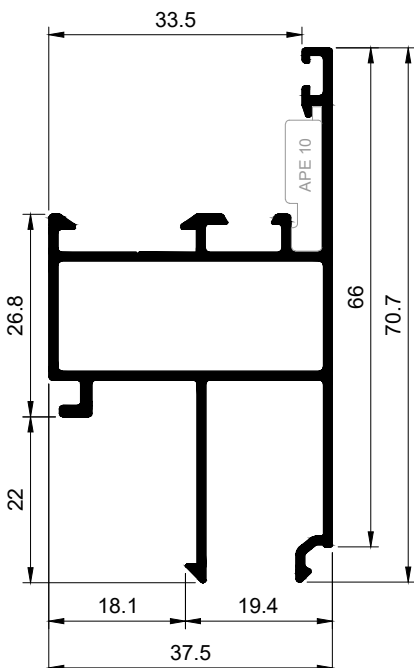

375 0315 Outer opening prof.	Weight (gr/m)	$I_x / I_y$ (cm <sup>4</sup> )	$W_x / W_y$ (cm <sup>3</sup> )
	758	7.90/4.80	2.16/2.07

JOINTS			
GASKETS			

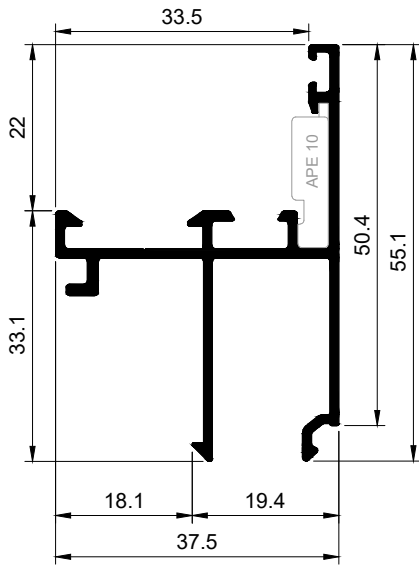

<b>375 0320</b> Outer opening prof.	Weight (gr/m)	$I_x / I_y$ (cm <sup>4</sup> )	$W_x / W_y$ (cm <sup>3</sup> )
	542	3.40/2.91	1.18/1.17
JOINTS	 APE 10		
GASKETS			

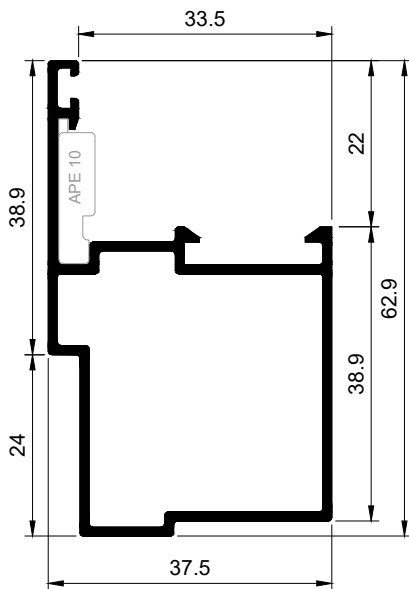

<b>375 0325</b> Addition for door	Weight (gr/m)	$I_x / I_y$ (cm <sup>4</sup> )	$W_x / W_y$ (cm <sup>3</sup> )
	638	7.50/4.82	2.09/2.26
JOINTS	 APE 10		
GASKETS			

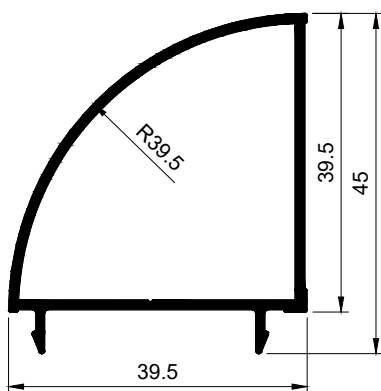

<b>375 0330</b> Column for 90° angle	Weight (gr/m)	$I_x / I_y$ (cm <sup>4</sup> )	$W_x / W_y$ (cm <sup>3</sup> )
	520	3.98/3.82	1.64/1.69

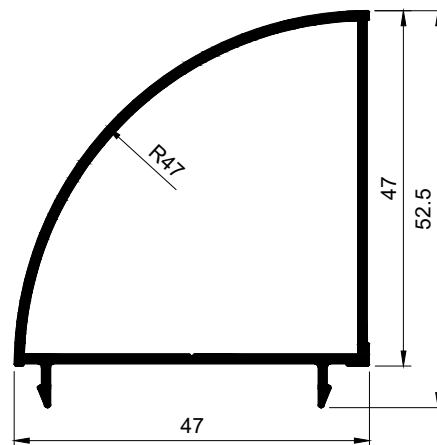

<b>375 0330-1</b> Column for 90° angle	Weight (gr/m)	$I_x / I_y$ (cm <sup>4</sup> )	$W_x / W_y$ (cm <sup>3</sup> )
	615	6.66/6.50	2.33/2.42

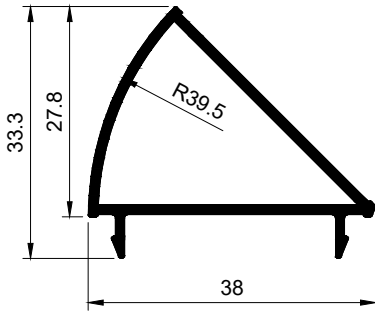

<b>375 0335</b> Column for 135° angle	Weight (gr/m)	$I_x / I_y$ (cm <sup>4</sup> )	$W_x / W_y$ (cm <sup>3</sup> )
	400	1.21/2.02	0.62/0.96

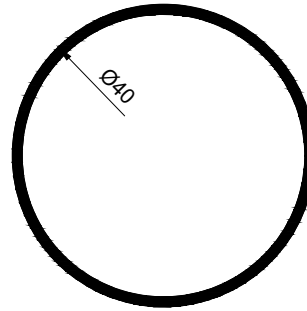

<b>375 0340</b> Pipe	Weight (gr/m)	$I_x / I_y$ (cm <sup>4</sup> )	$W_x / W_y$ (cm <sup>3</sup> )
	428	2.96/2.96	1.48/1.48

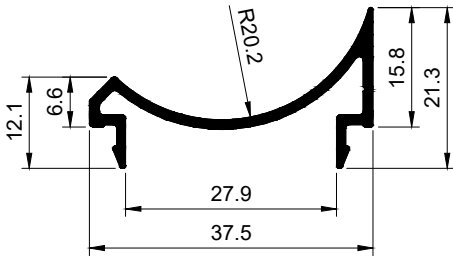

<b>375 0345</b> Addition for pipe	Weight (gr/m)	$I_x / I_y$ (cm <sup>4</sup> )	$W_x / W_y$ (cm <sup>3</sup> )
	279	0.18/1.91	0.14/0.88

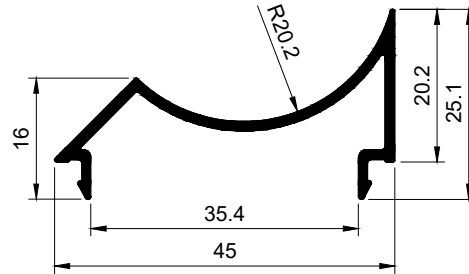

<b>375 0345-1</b> Addition for pipe	Weight (gr/m)	$I_x / I_y$ (cm <sup>4</sup> )	$W_x / W_y$ (cm <sup>3</sup> )
	315	0.31/2.95	0.22/1.09

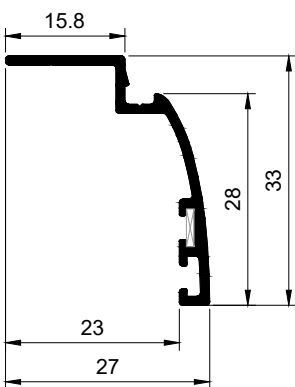

<b>375 0350</b> Decoration profile	Weight (gr/m)	$I_x / I_y$ (cm <sup>4</sup> )	$W_x / W_y$ (cm <sup>3</sup> )
	225	0.99/0.44	0.51/0.23

JOINTS	APE 6	GASKETS	U 60
--------	-------	---------	------

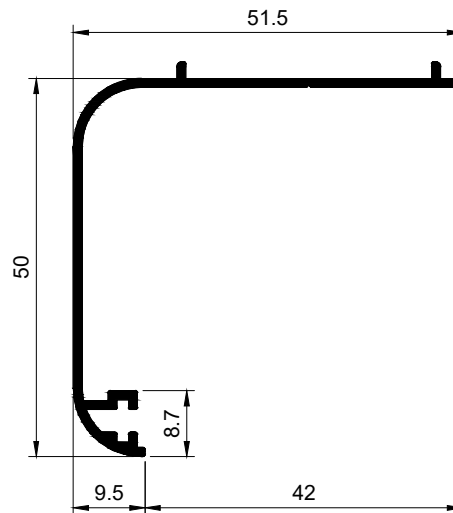

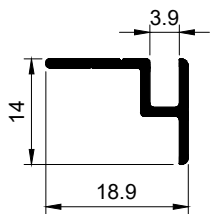

<b>375 0350-1</b> Edge	Weight (gr/m)	$I_x / I_y$ (cm <sup>4</sup> )	$W_x / W_y$ (cm <sup>3</sup> )
	385	4.97/3.56	1.53/0.94

JOINTS	APE 6	GASKETS	U 60
--------	-------	---------	------

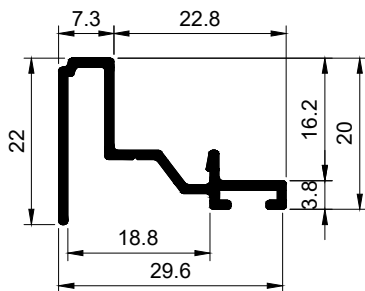

<b>375 0355</b> Decoration profile	Weight (gr/m)
	123



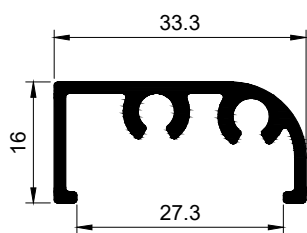

<b>375 0360</b> Addition for door	Weight (gr/m)	$I_x / I_y$ (cm <sup>4</sup> )	$W_x / W_y$ (cm <sup>3</sup> )
	255	0.35/0.90	0.29/0.48
BRUSHES	 TZ 12;TZ18;		

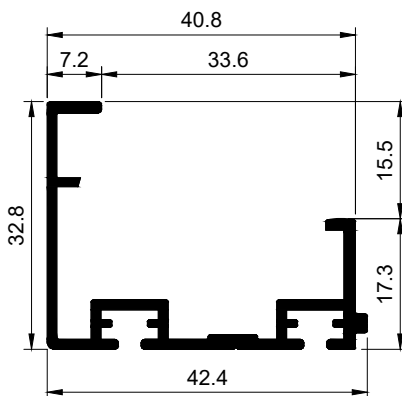

<b>375 0365</b> Door sill	Weight (gr/m)
	379



<b>375 0361</b> Addition for door	Weight (gr/m)	$I_x / I_y$ (cm <sup>4</sup> )	$W_x / W_y$ (cm <sup>3</sup> )
	488	1.63/4.31	0.68/1.79
BRUSHES	 TZ 5.5		
CAPS			SET APE 361

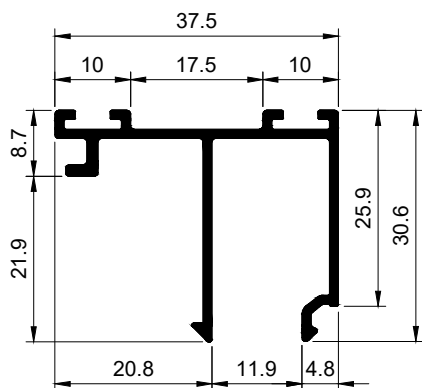

<b>375 0415</b> Two-sides addition	Weight (gr/m)	$I_x / I_y$ (cm <sup>4</sup> )	$W_x / W_y$ (cm <sup>3</sup> )
	395	1.25/2.10	0.61/0.95

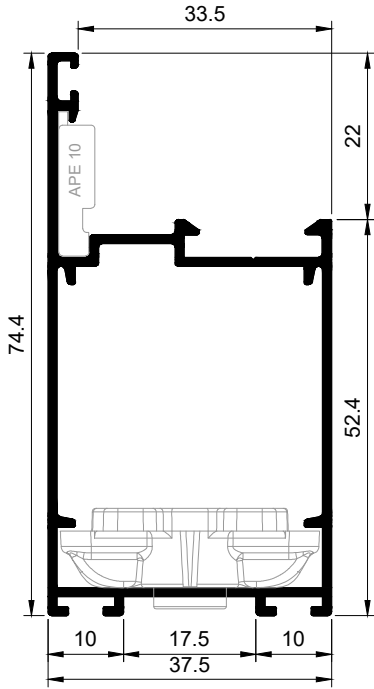

<b>375 0410</b> Two-sides sash	Weight (gr/m)	$I_x / I_y$ (cm <sup>4</sup> )	$W_x / W_y$ (cm <sup>3</sup> )
	783	14.21/6.69	3.30/3.17
JOINTS	 APE 10      APE 3		
GASKETS	 U 00.0;1;1.5; 2;2.5;3;4;5      U 68      US 68		
BRUSHES	 TZ 12;TZ18;		

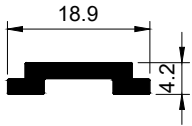

<b>9316</b> Espagnolette	Weight (gr/m)
	152

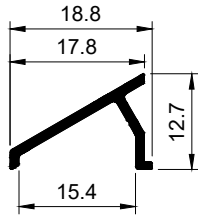

<b>9317</b> Profile larmier	Weight (gr/m)
	106

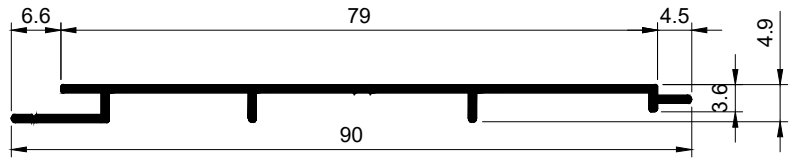

<b>1852</b> Aluminium panel	Weight (gr/m)
	326



<b>9358</b> Aluminium panel	Weight (gr/m)
	804

**GLASS HOLDERS**

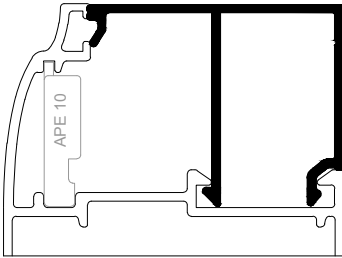

**375 0510**  
/0mm glass bead/  
weight: 290gr/m

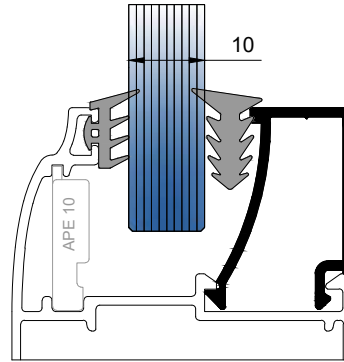

**9312**  
/10mm glass bead/  
weight: 235gr/m

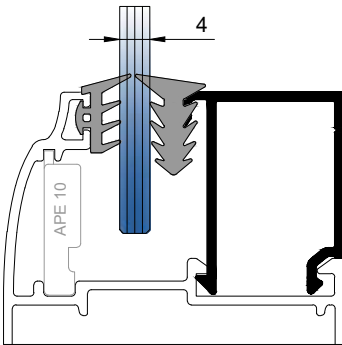

**375 0520**  
/4mm glass bead/  
weight: 268gr/m

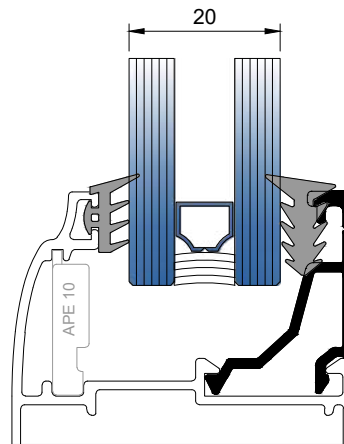

**1017**  
/20mm glass bead/  
weight: 222gr/m

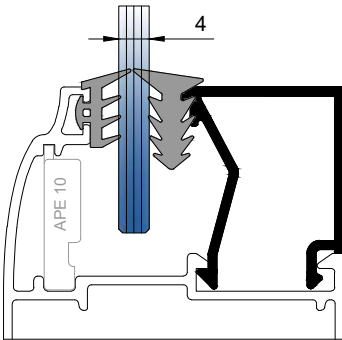

**1200**  
/4mm glass bead/  
weight: 270gr/m

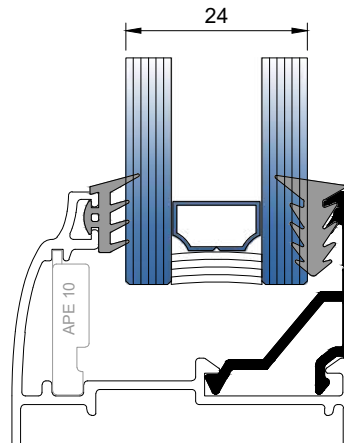

**375 0550**  
/24mm glass bead/  
weight: 203gr/m

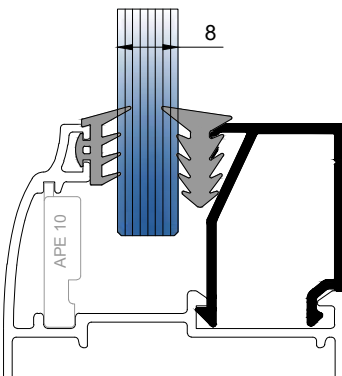

**375 0530**  
/8mm glass bead/  
weight: 260gr/m



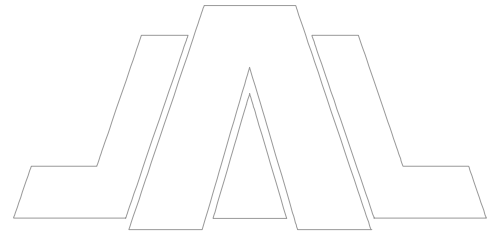

# SECTIONS

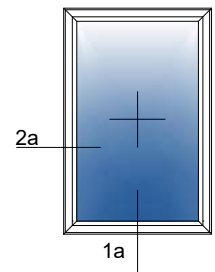
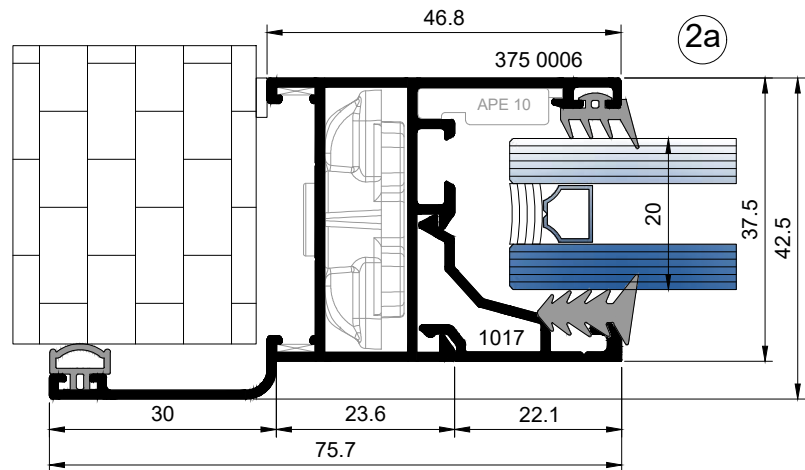
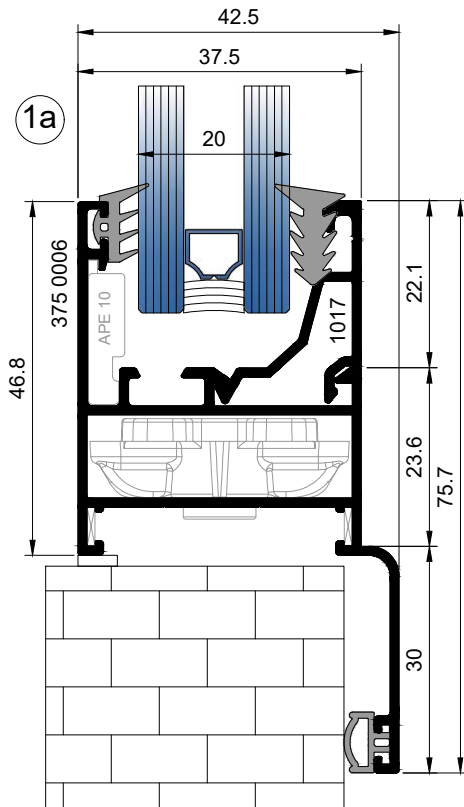
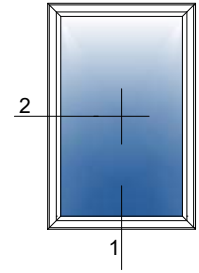
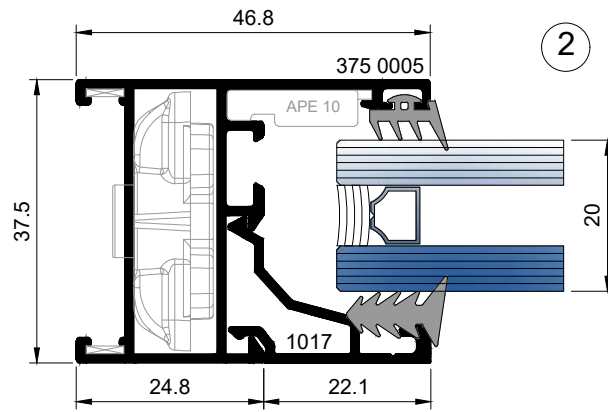
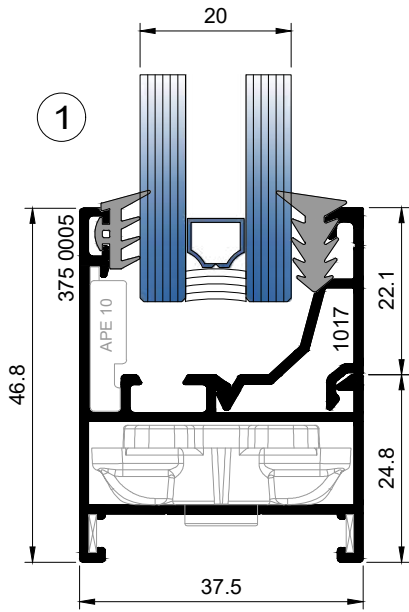

2a

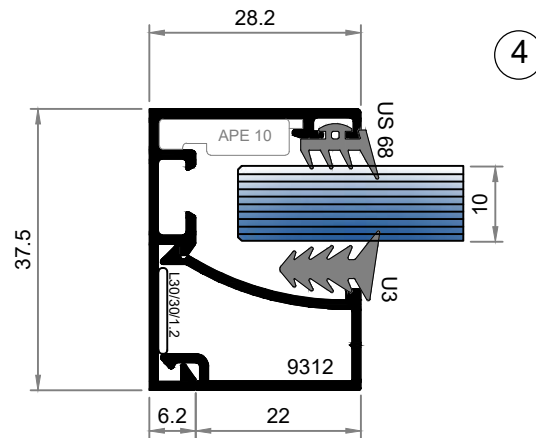
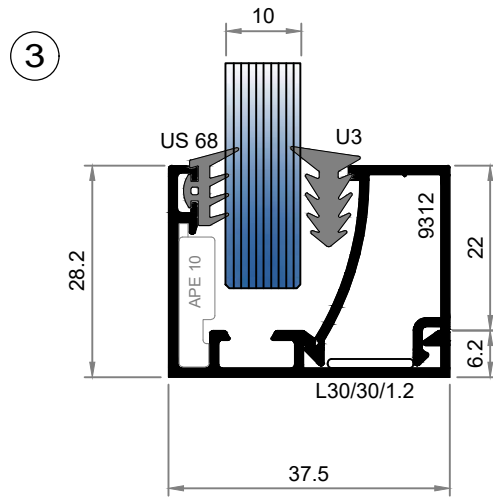
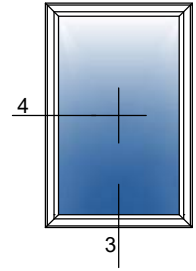

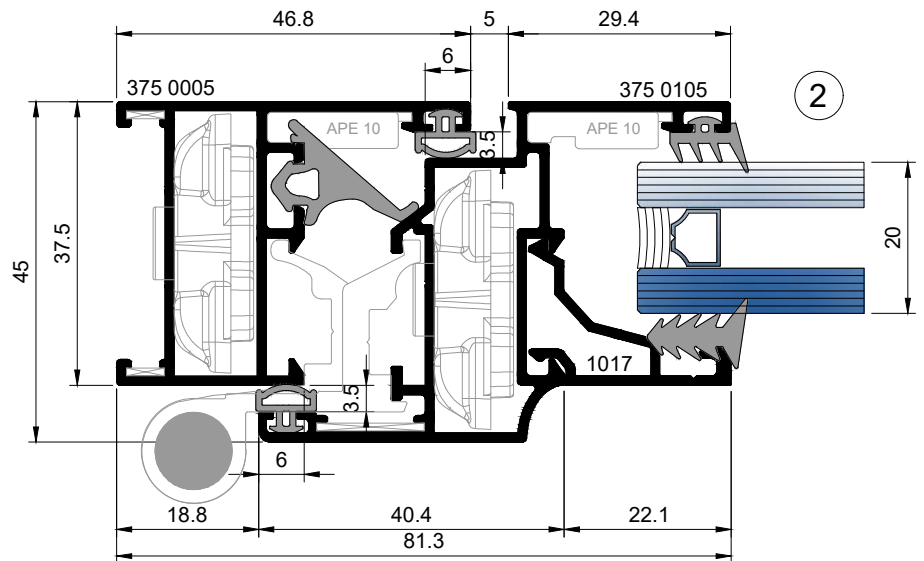
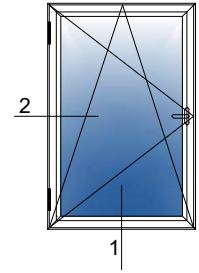
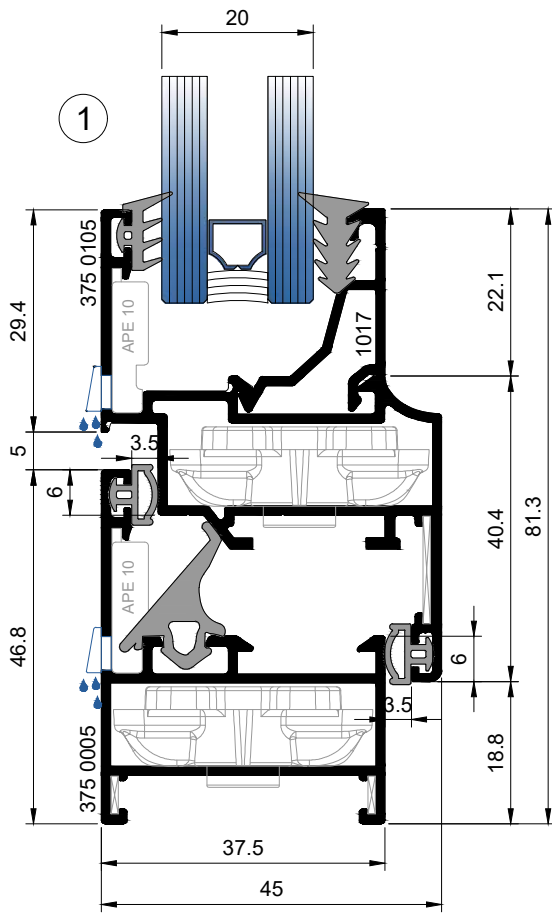

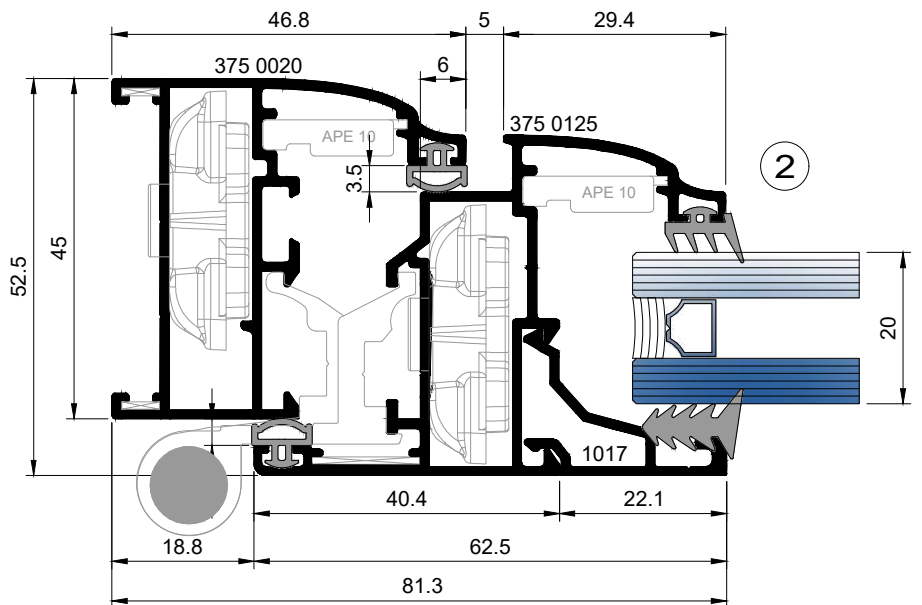
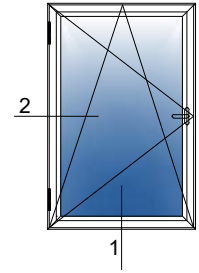
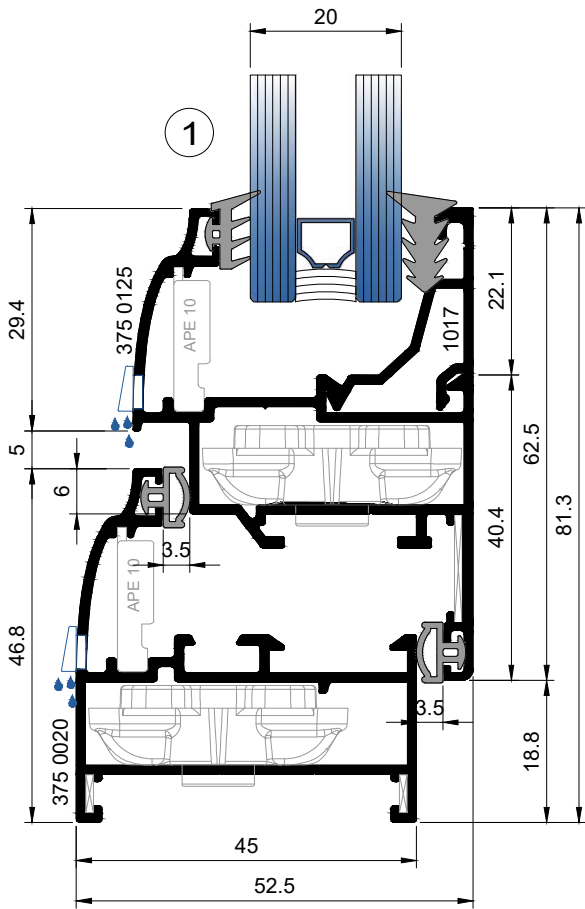

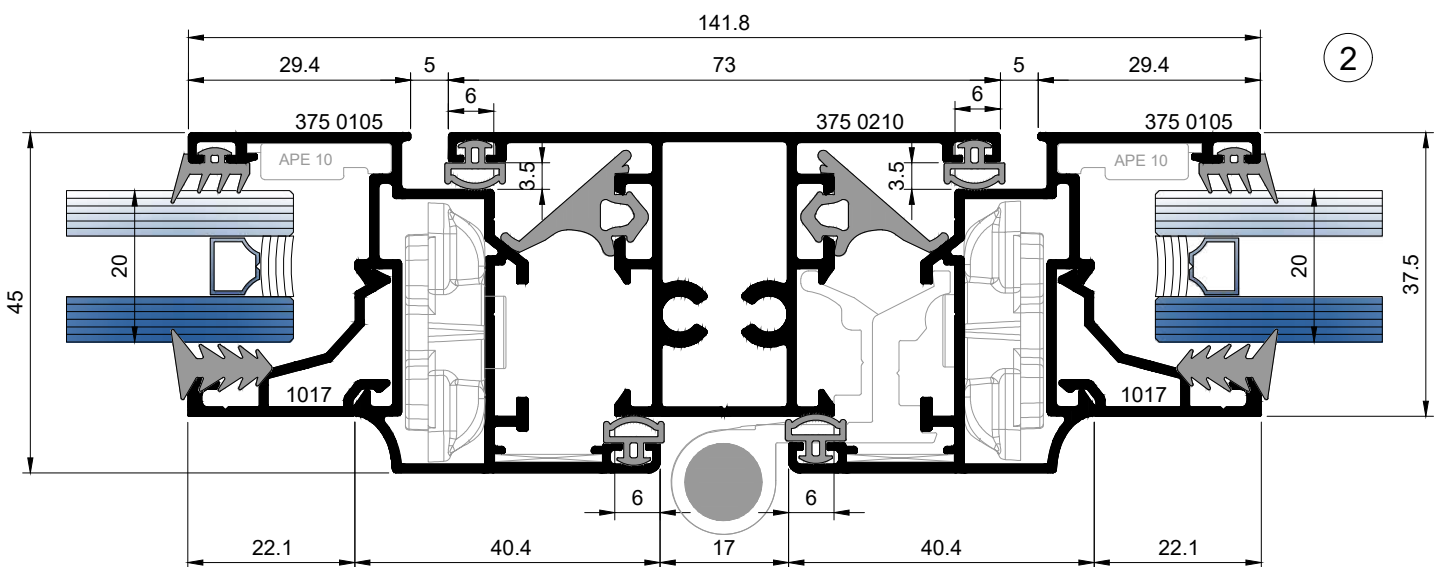
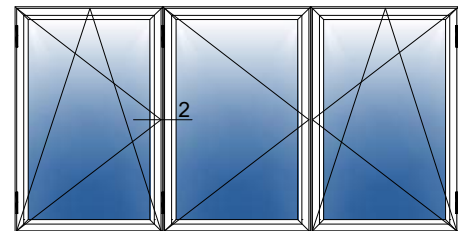
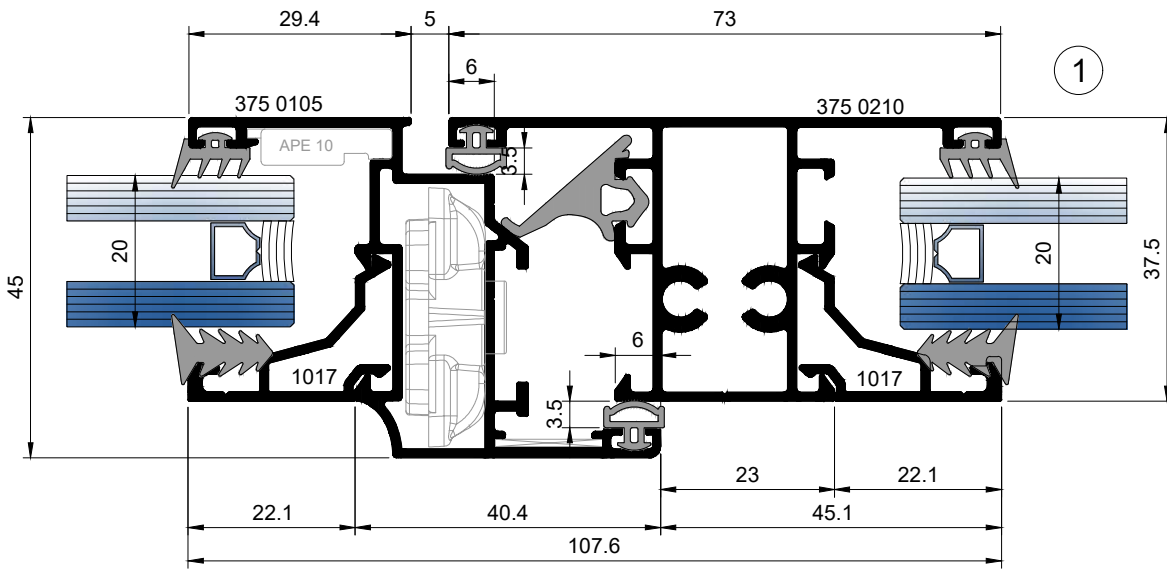
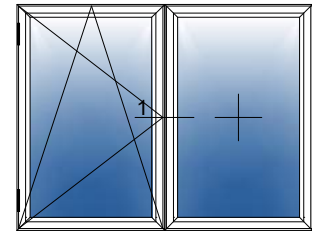

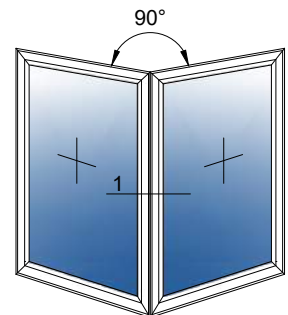
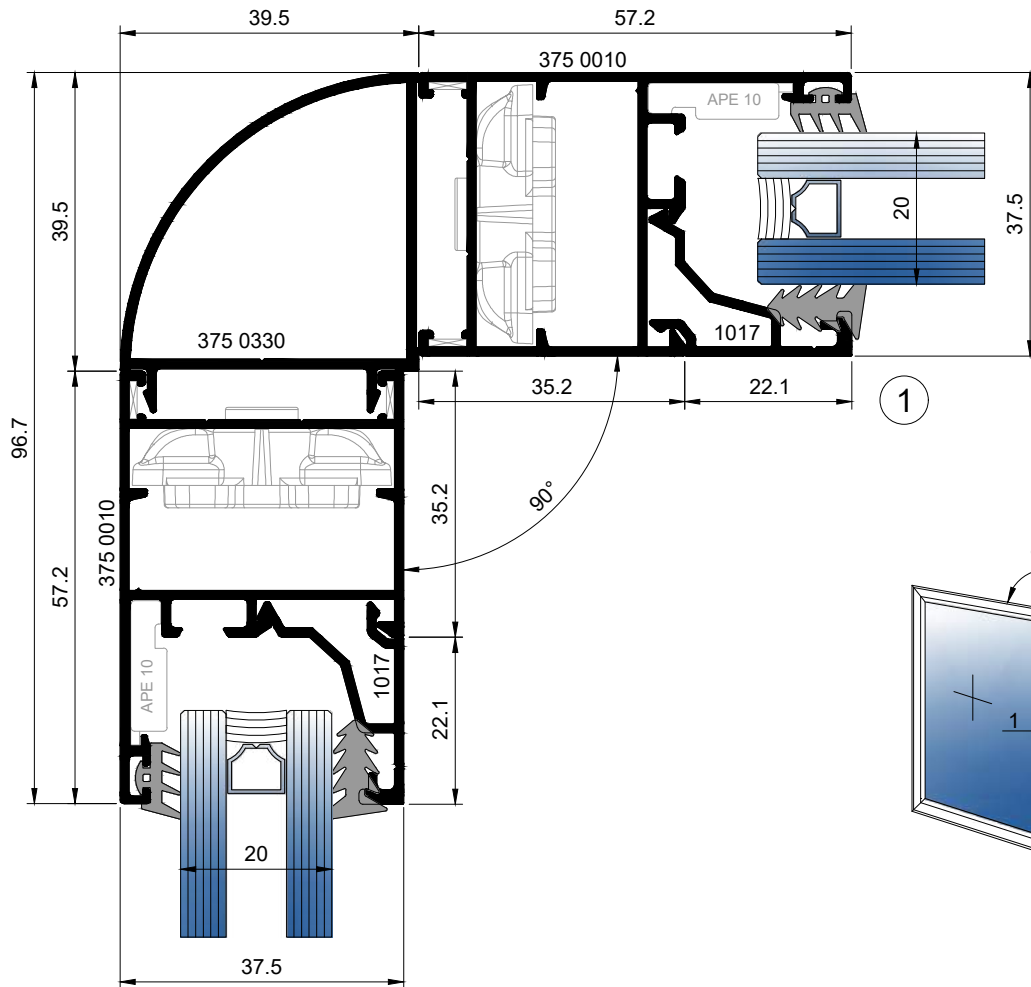
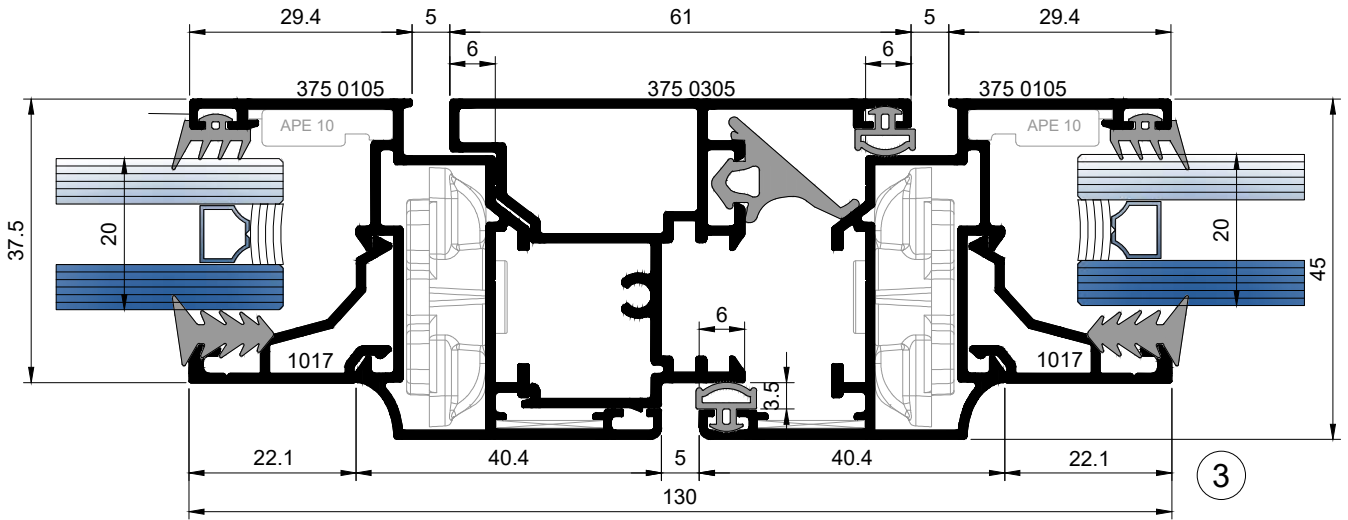
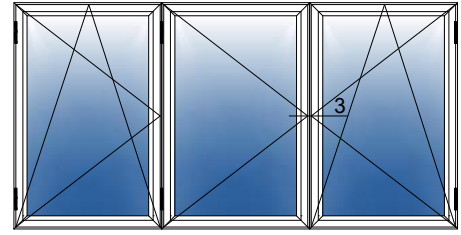

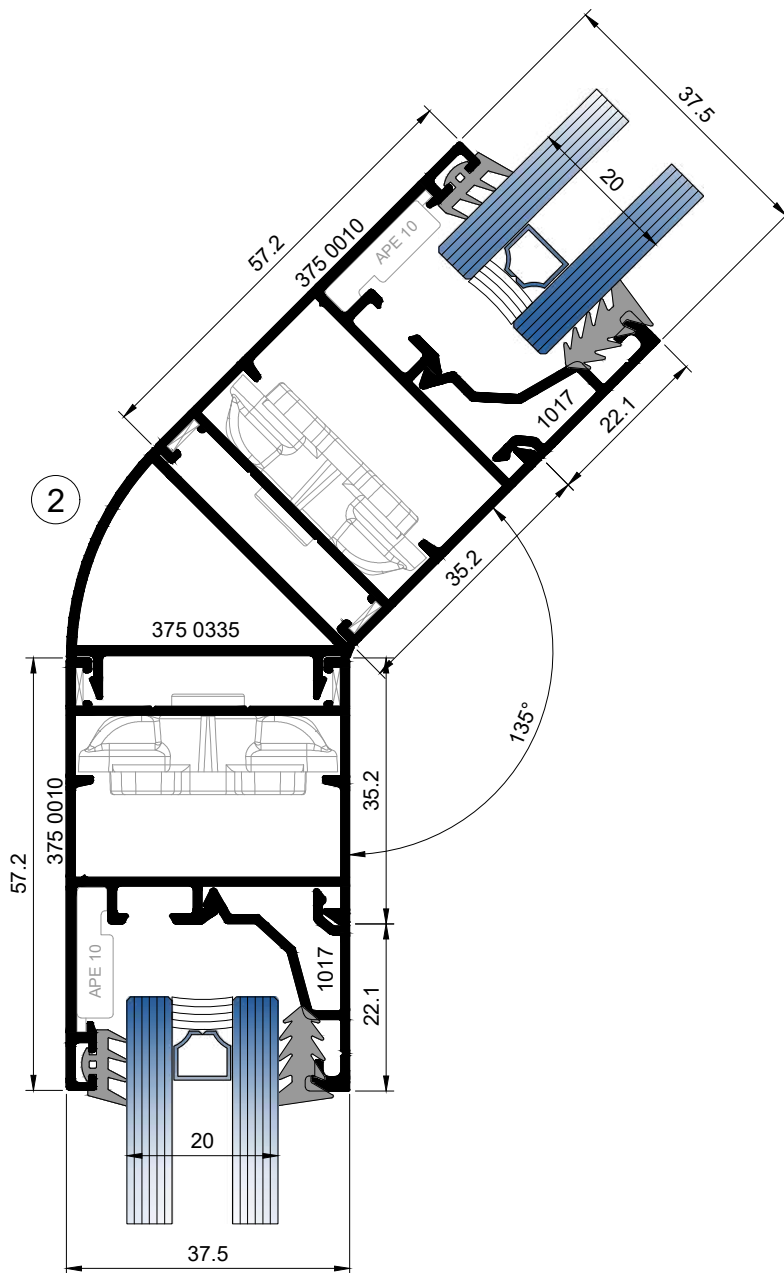
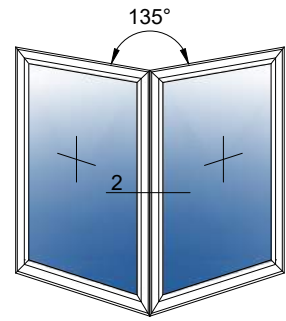



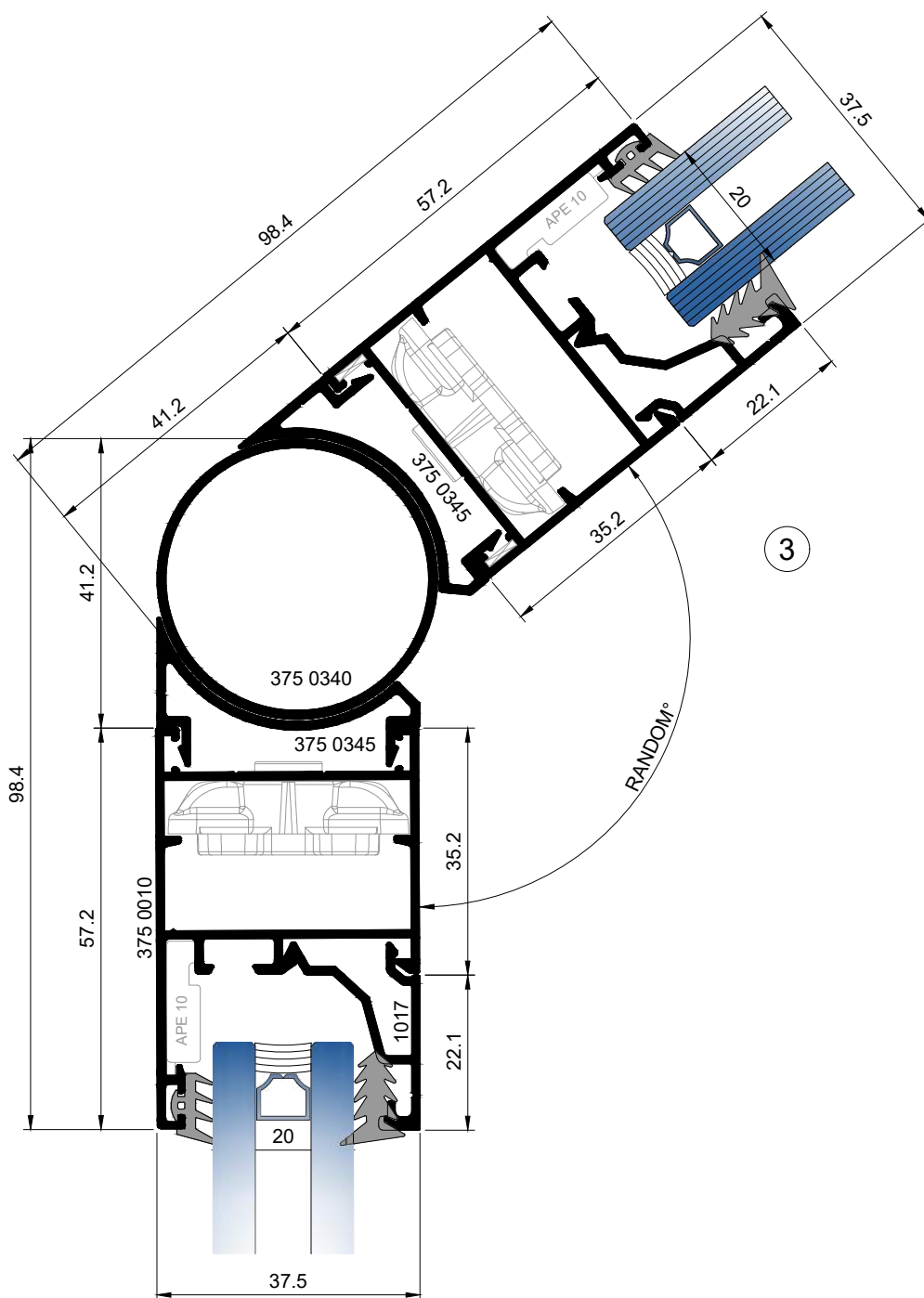
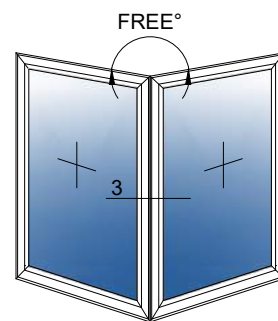

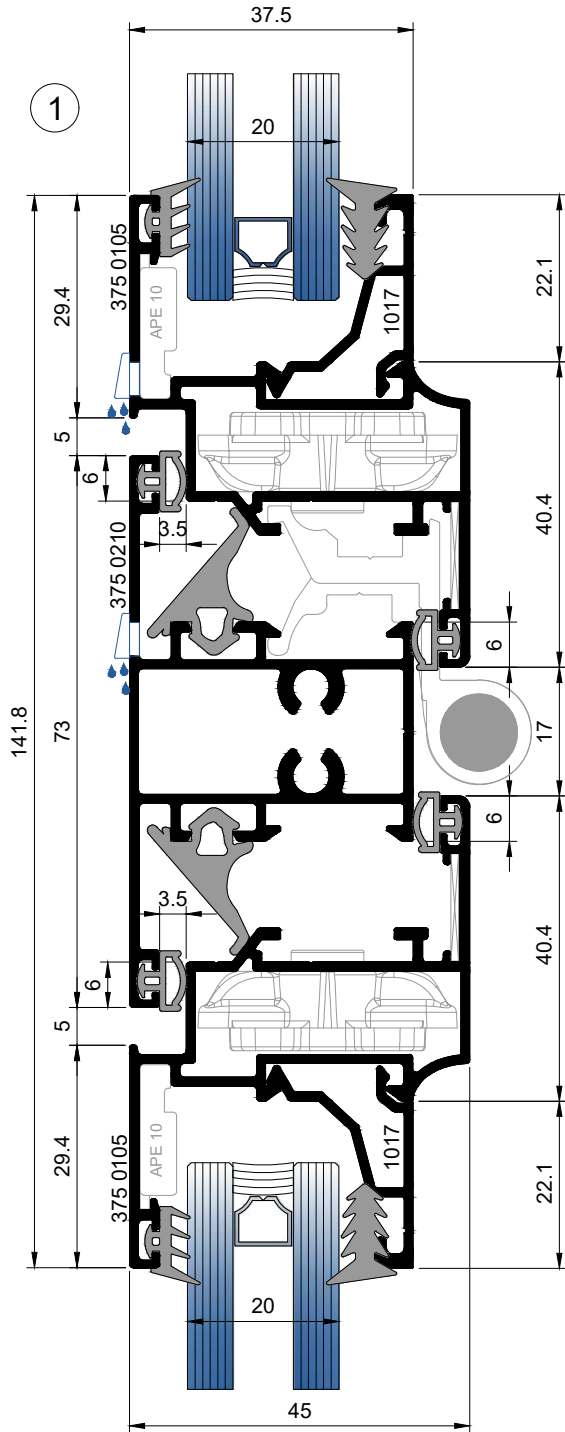
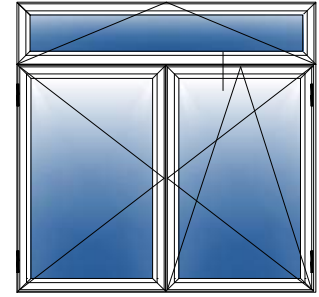

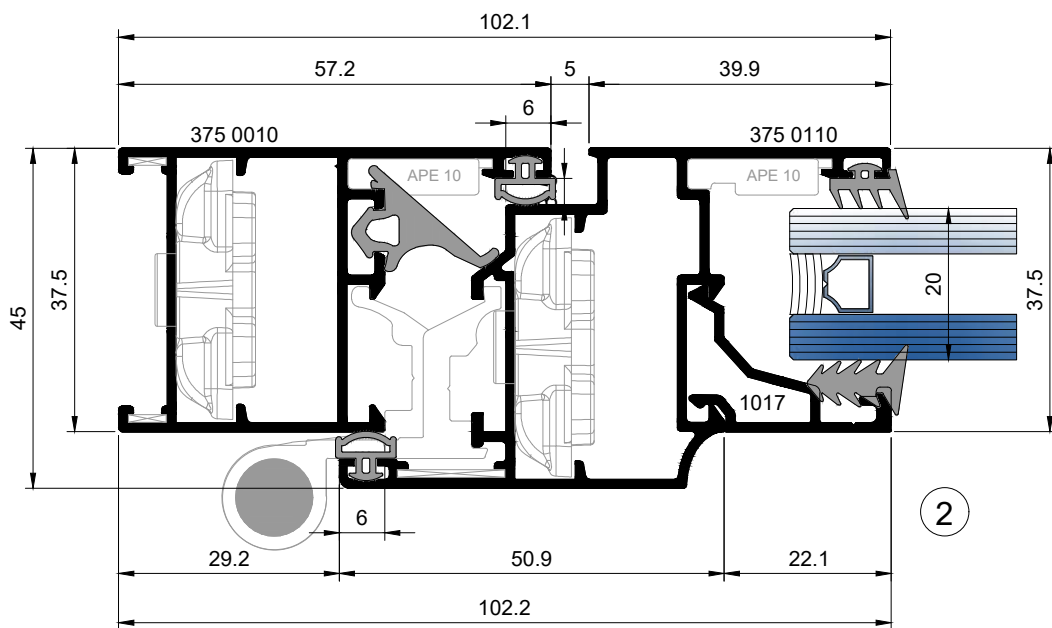
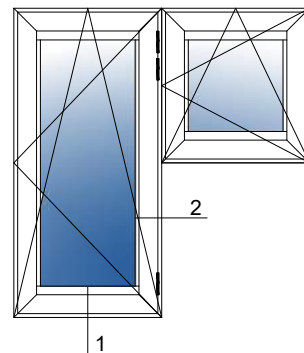
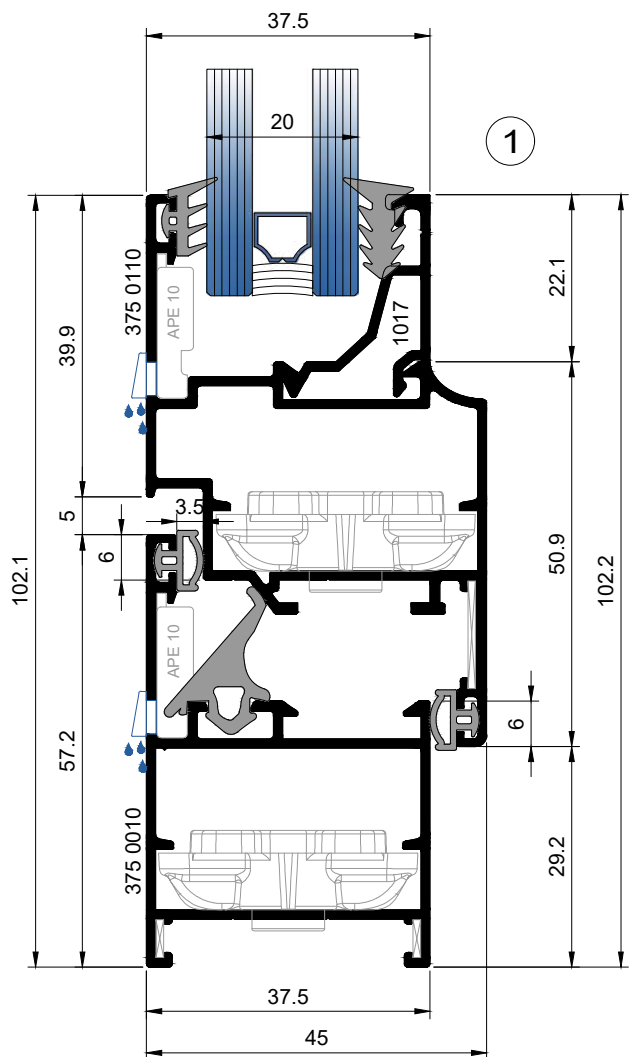

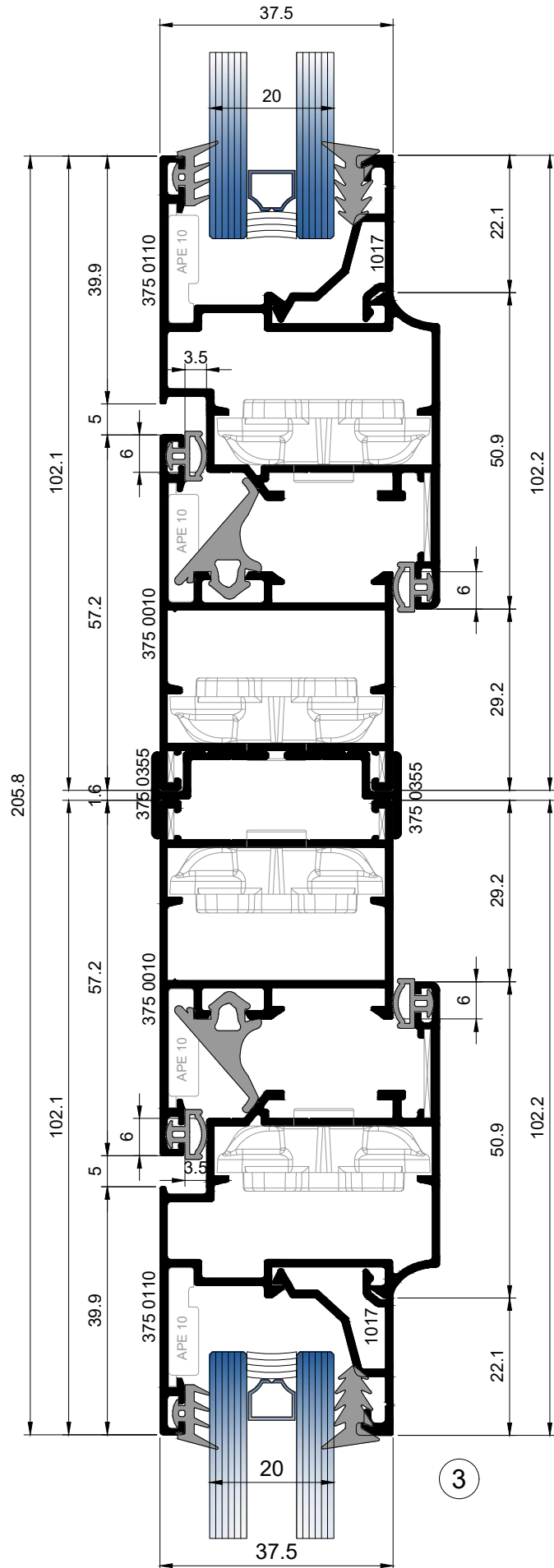
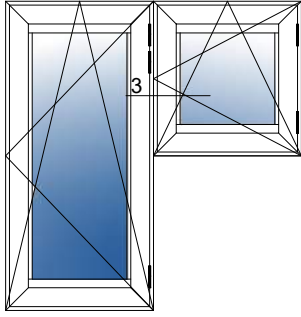

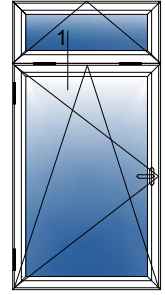
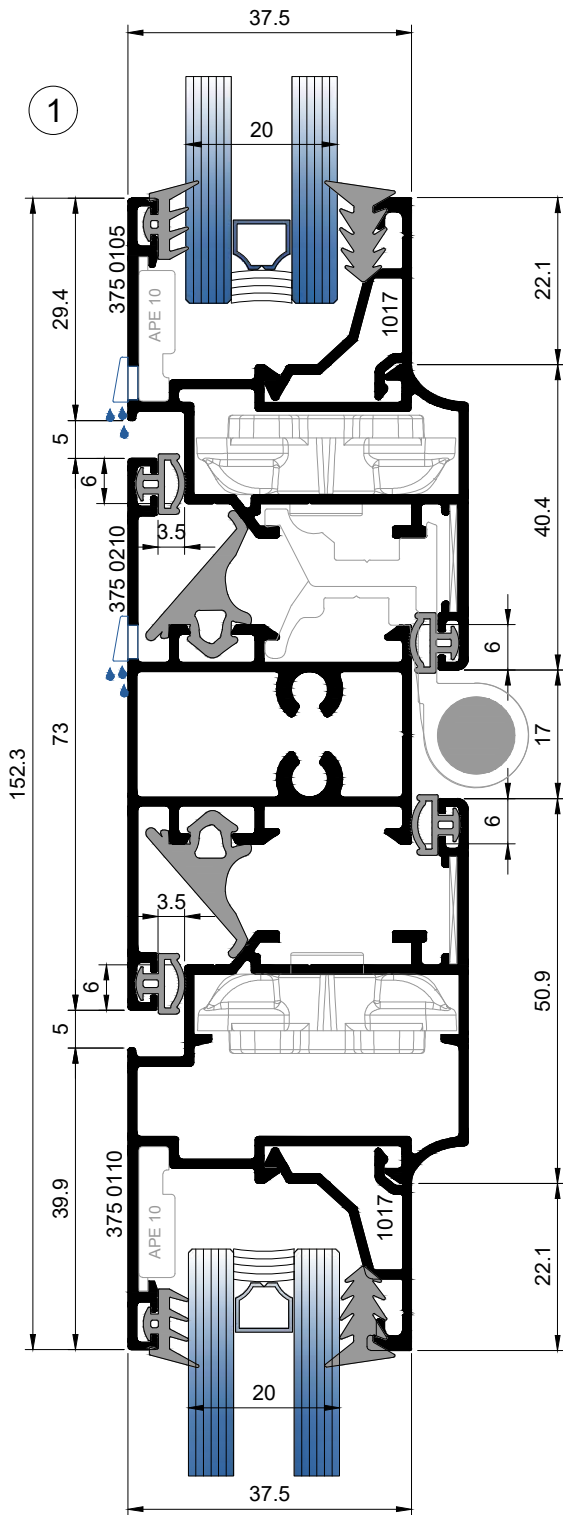

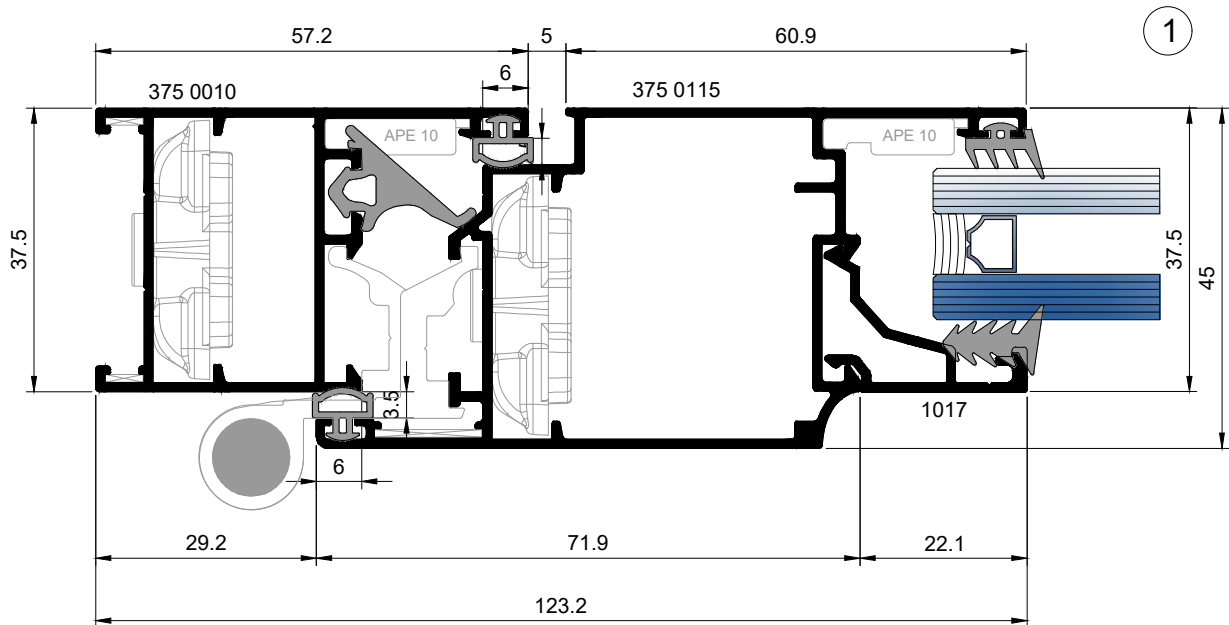
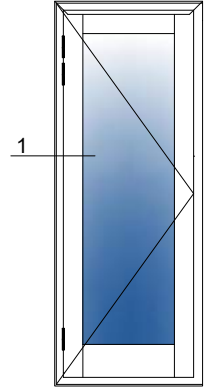

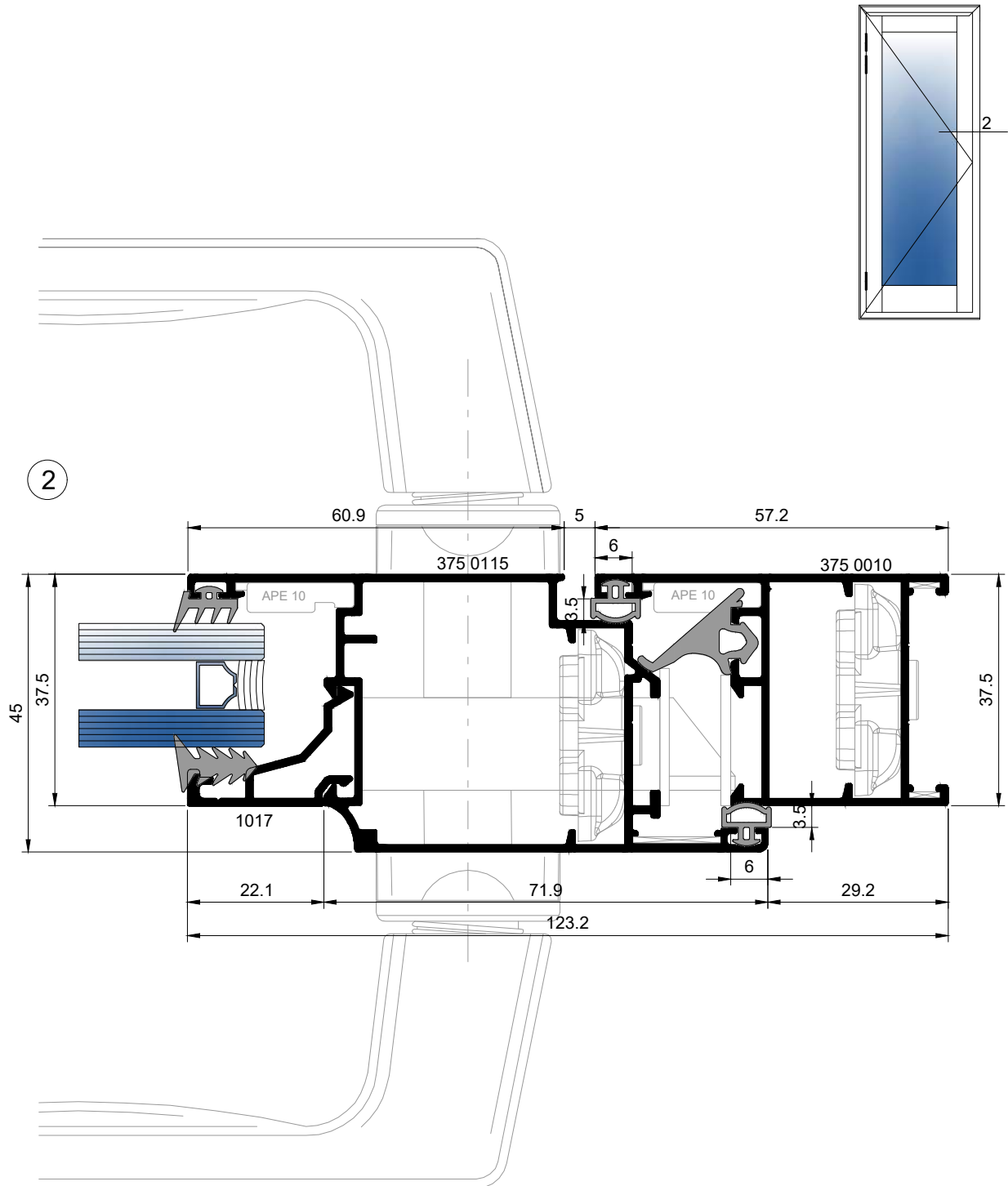

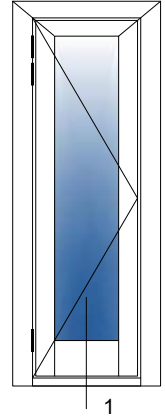
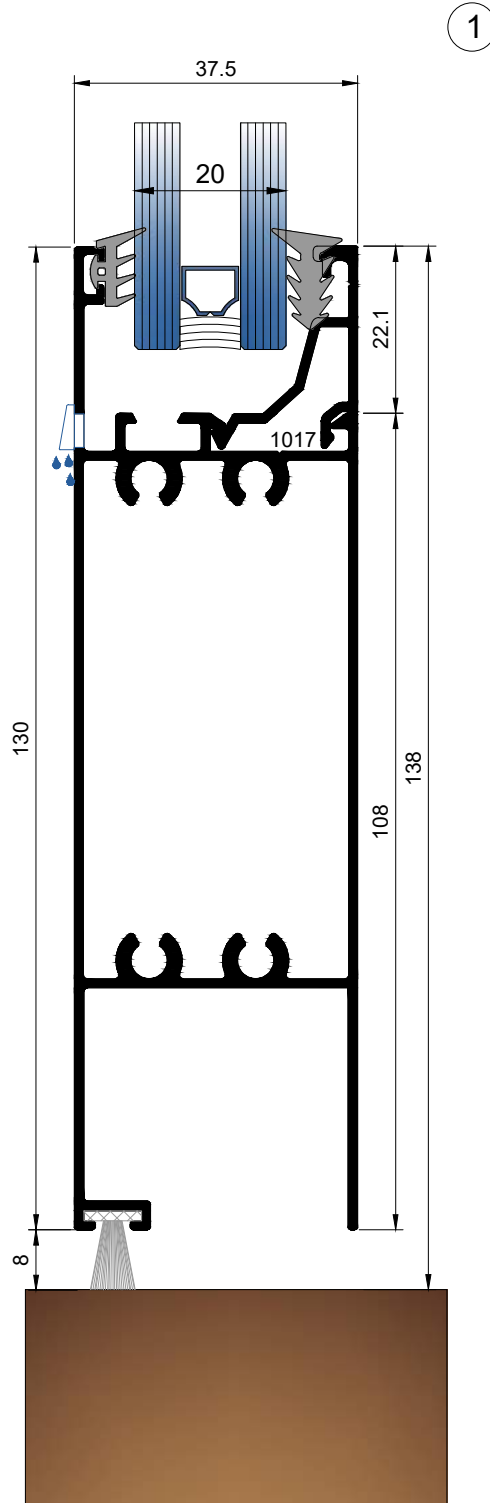



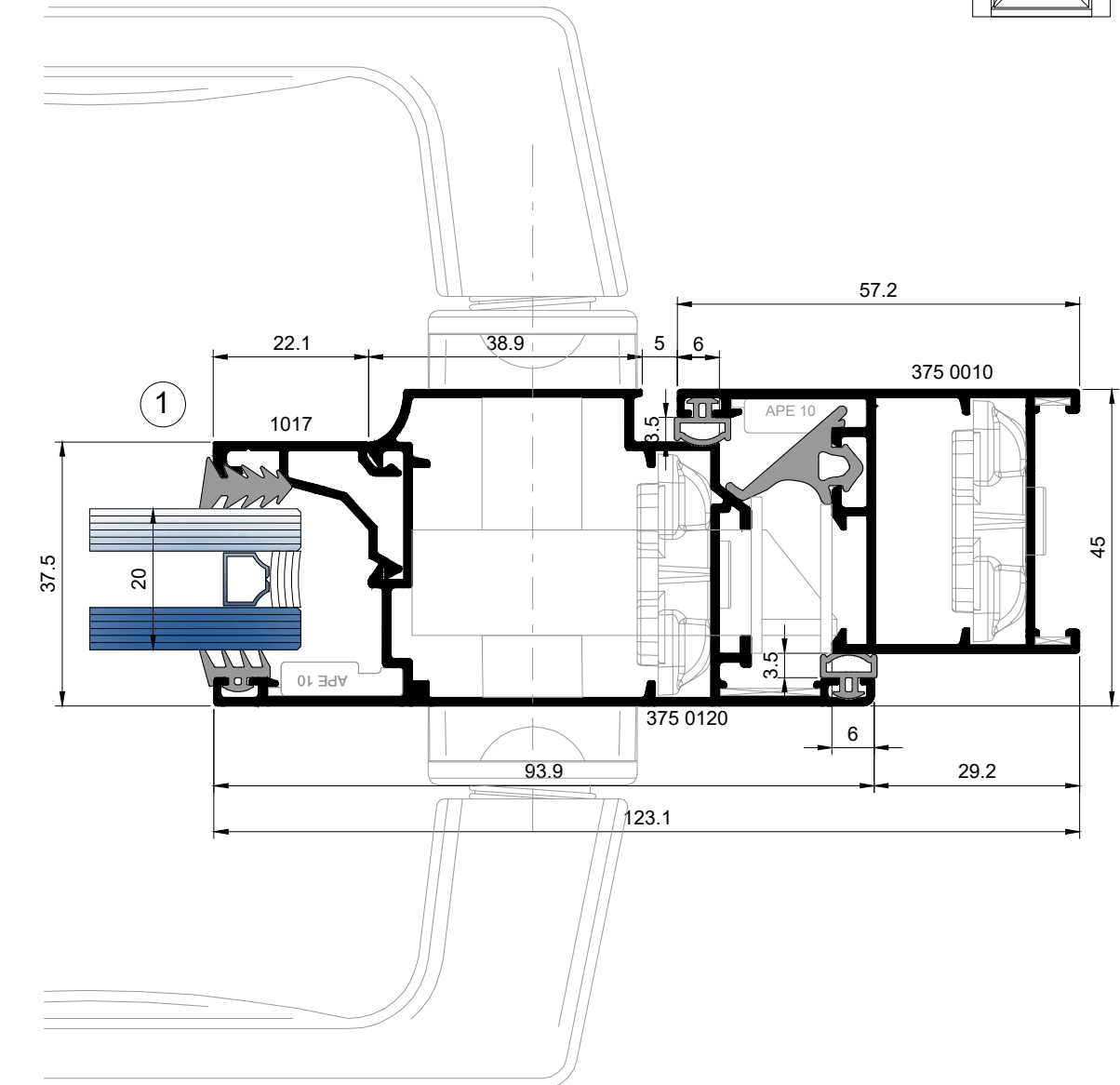
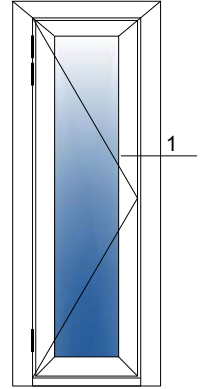

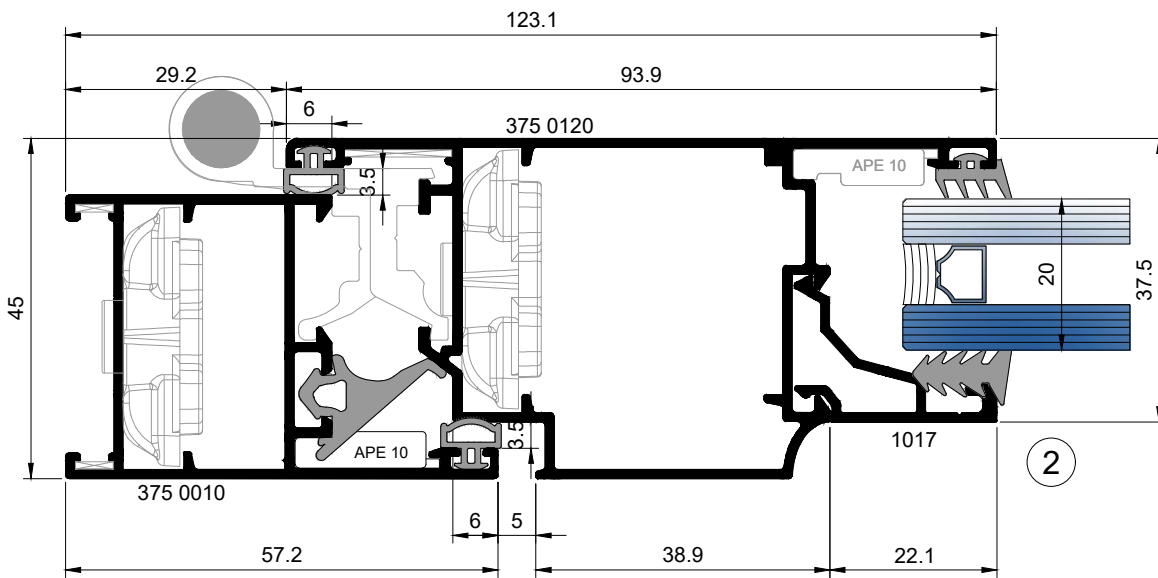
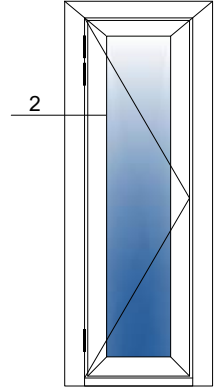

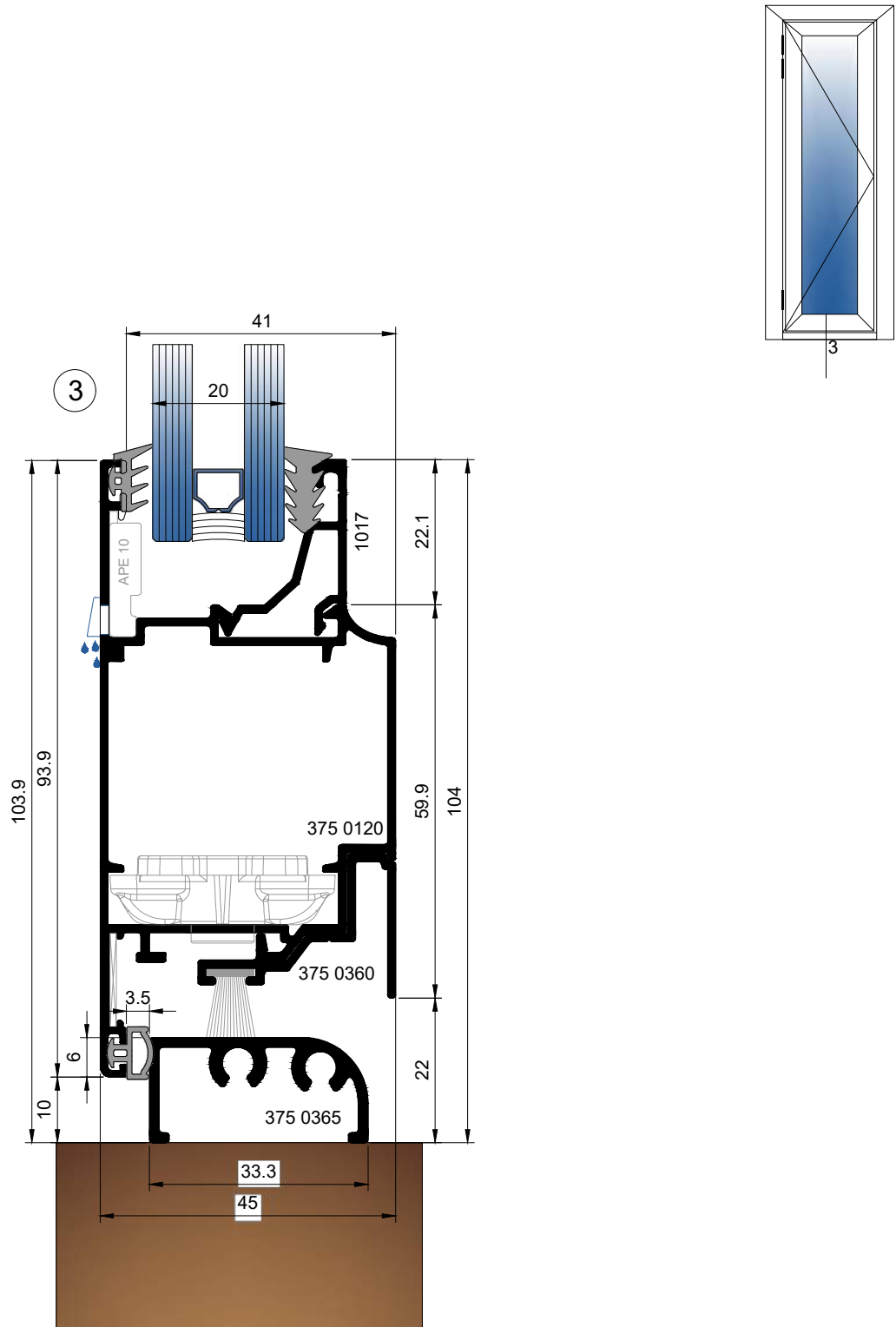

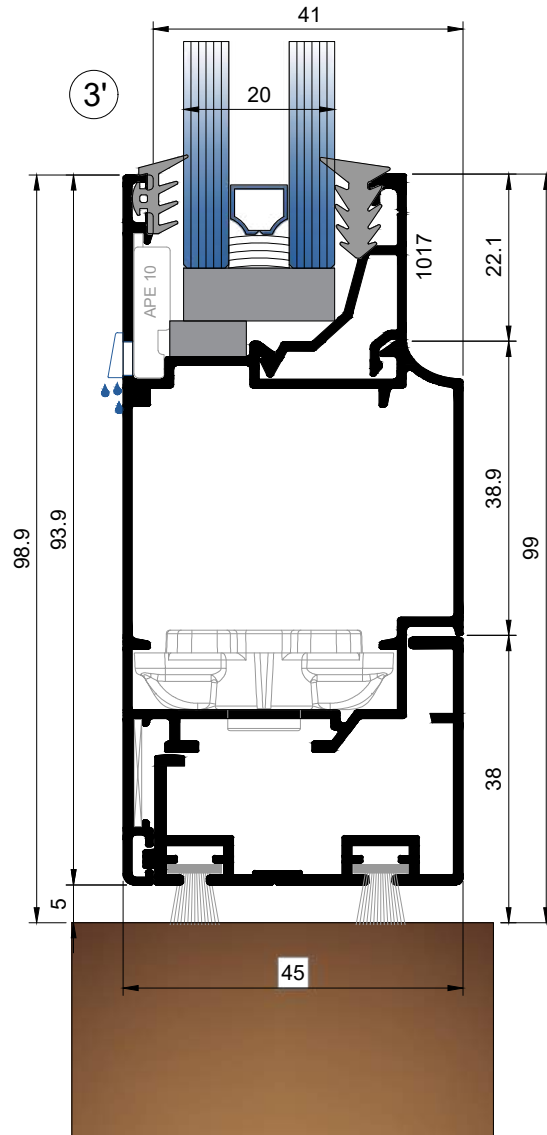
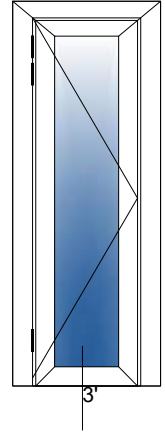

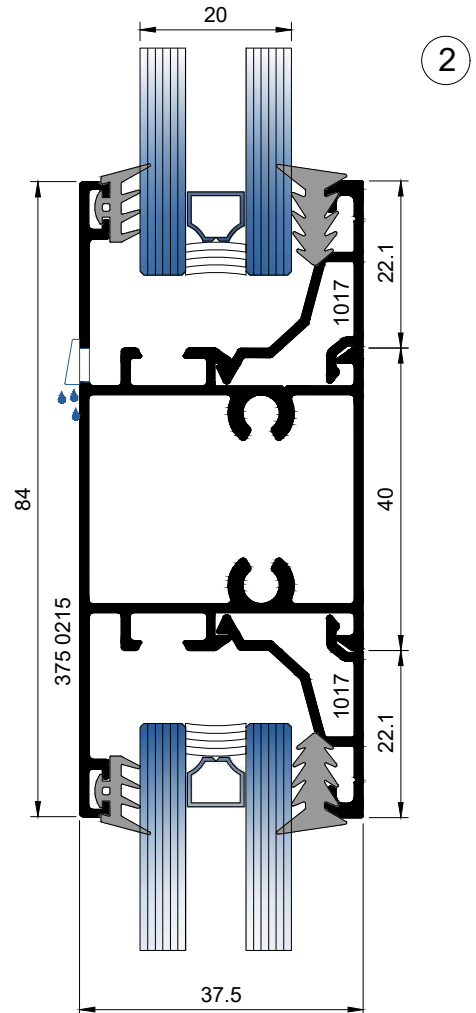
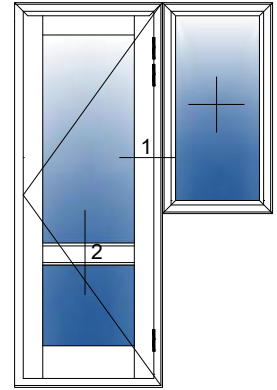
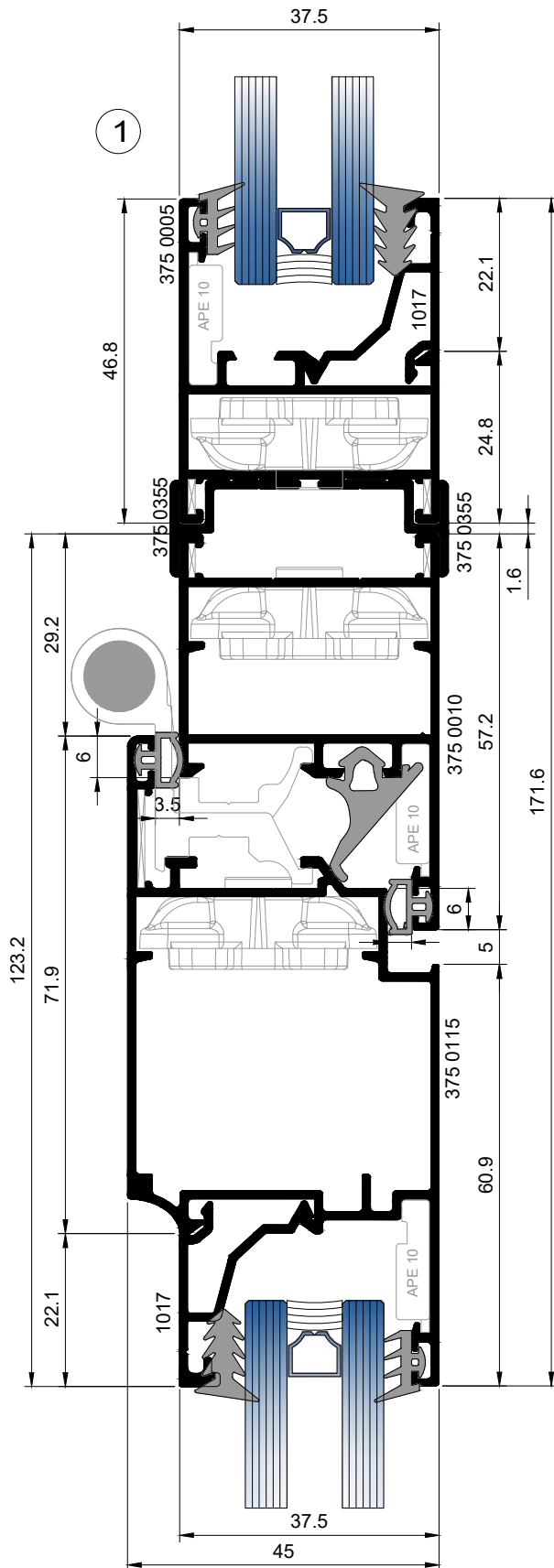

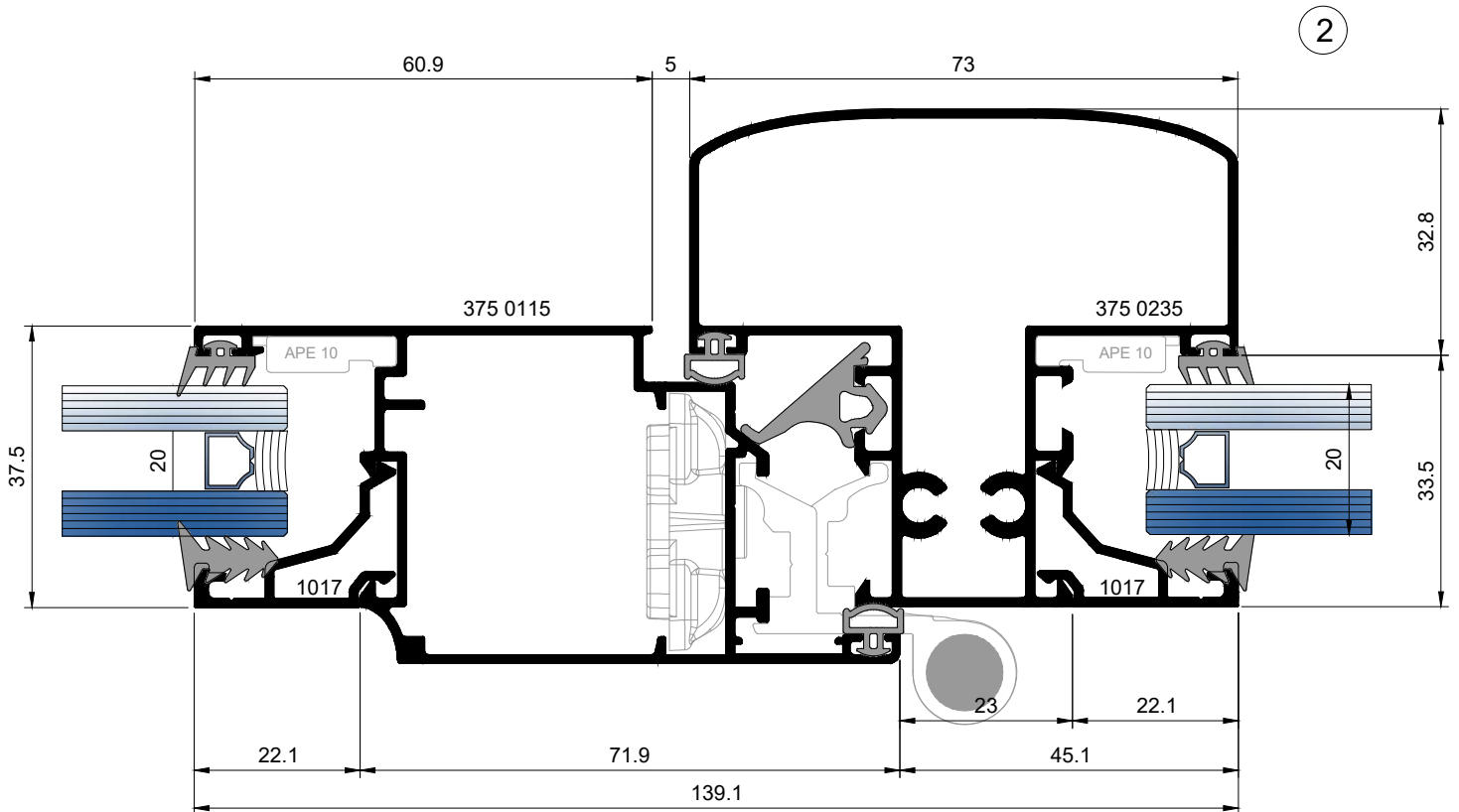
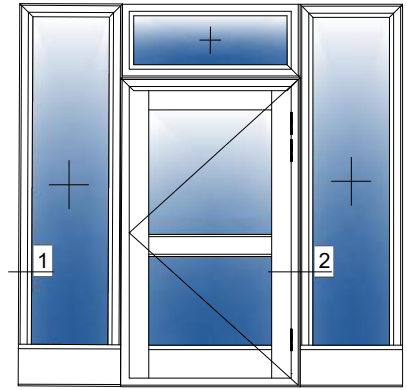
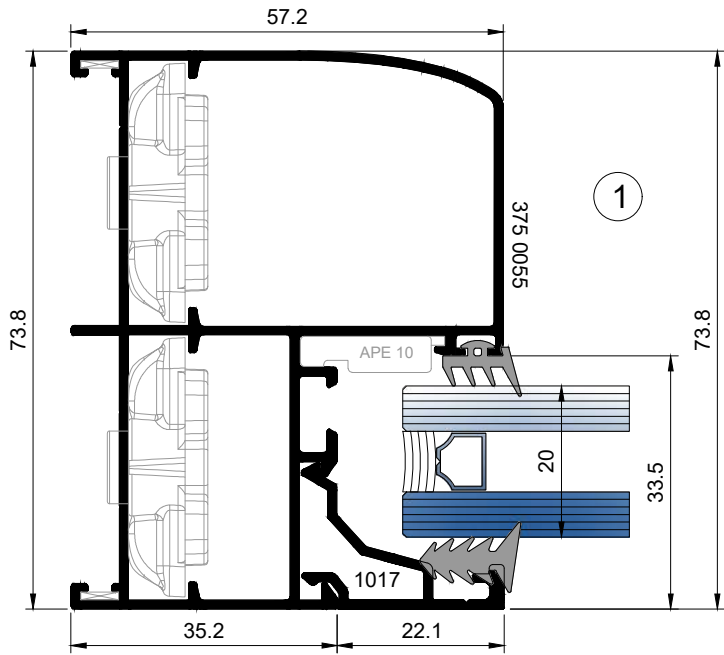

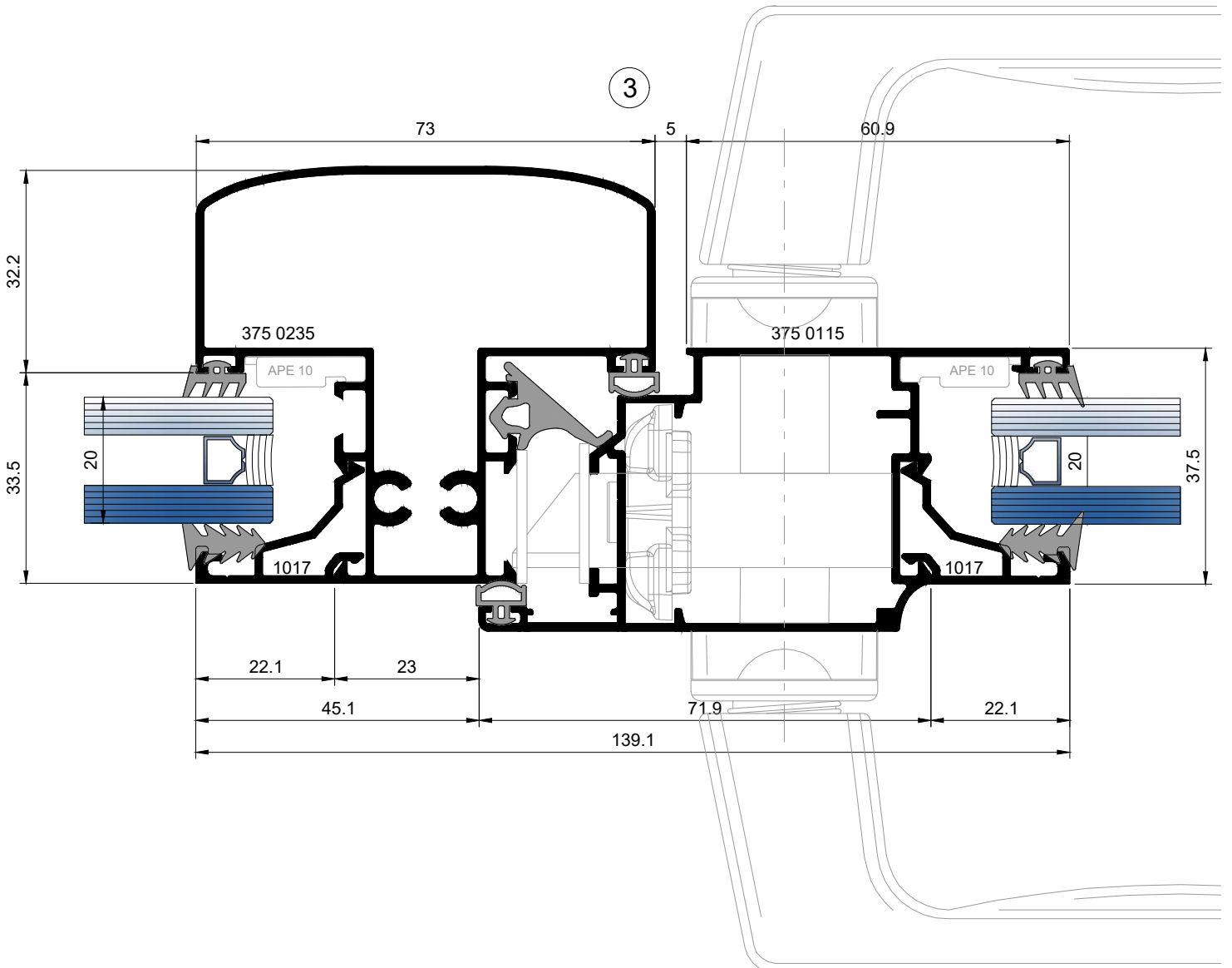
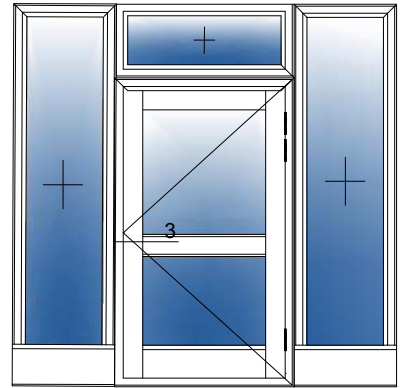

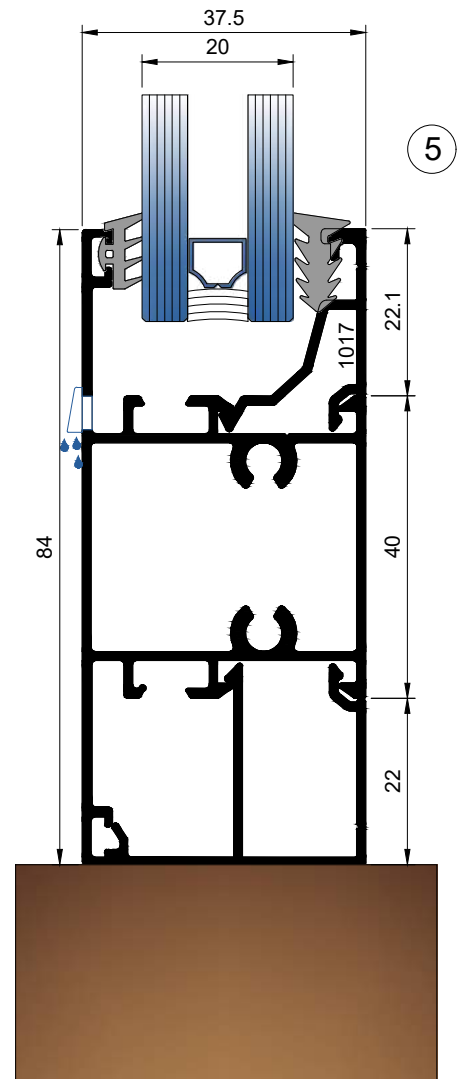
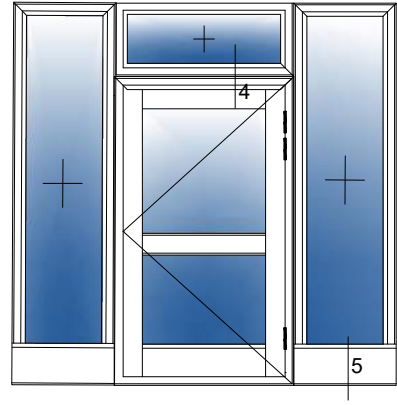
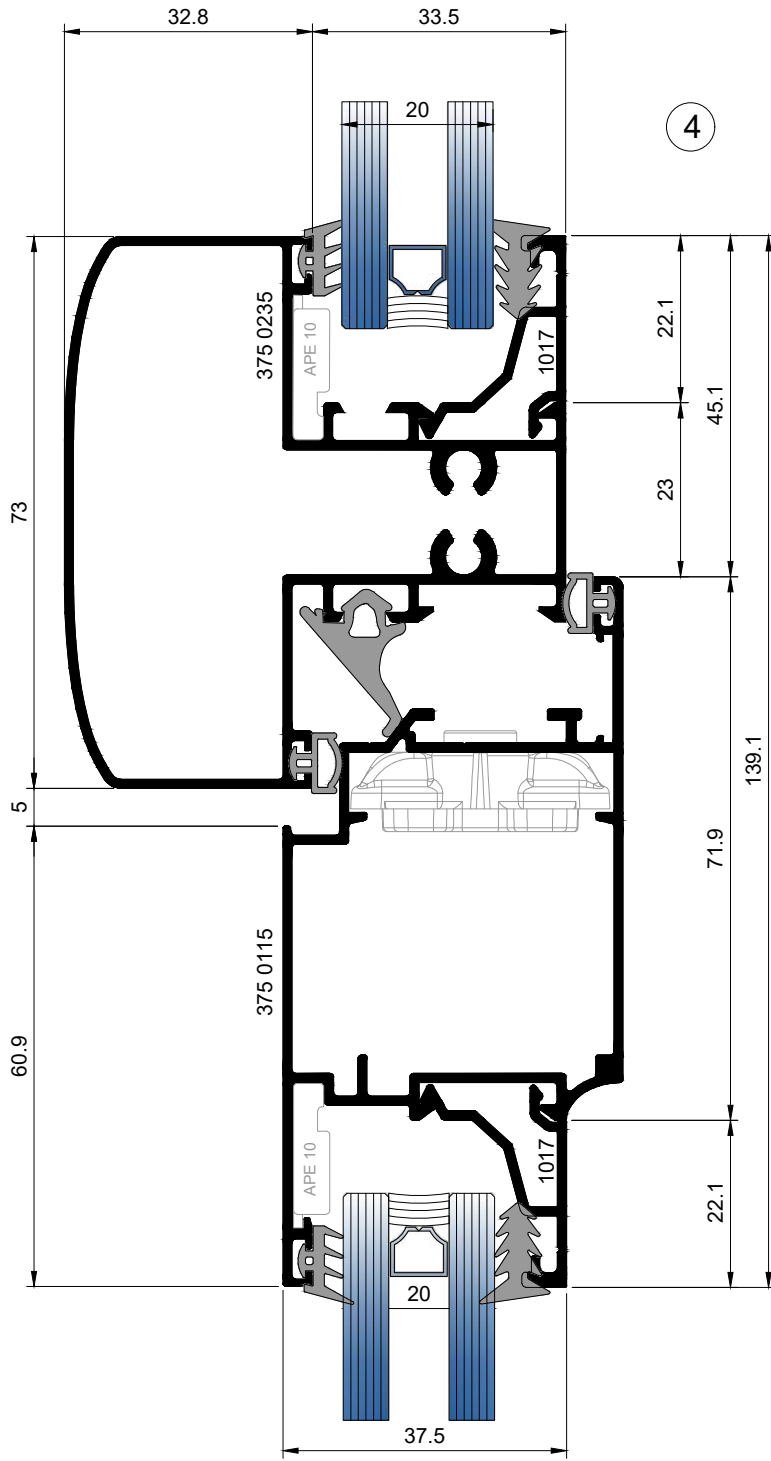



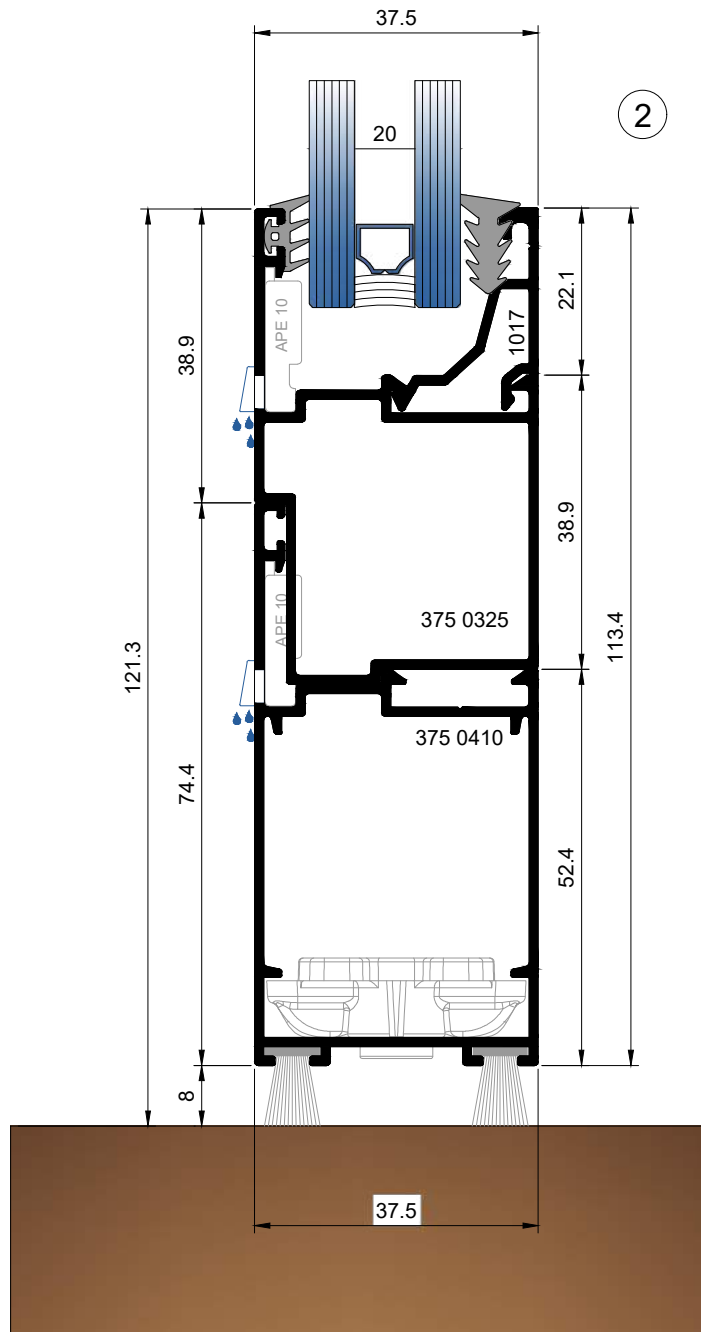
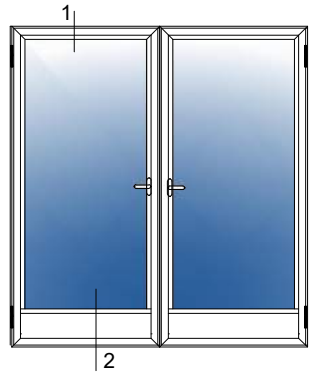
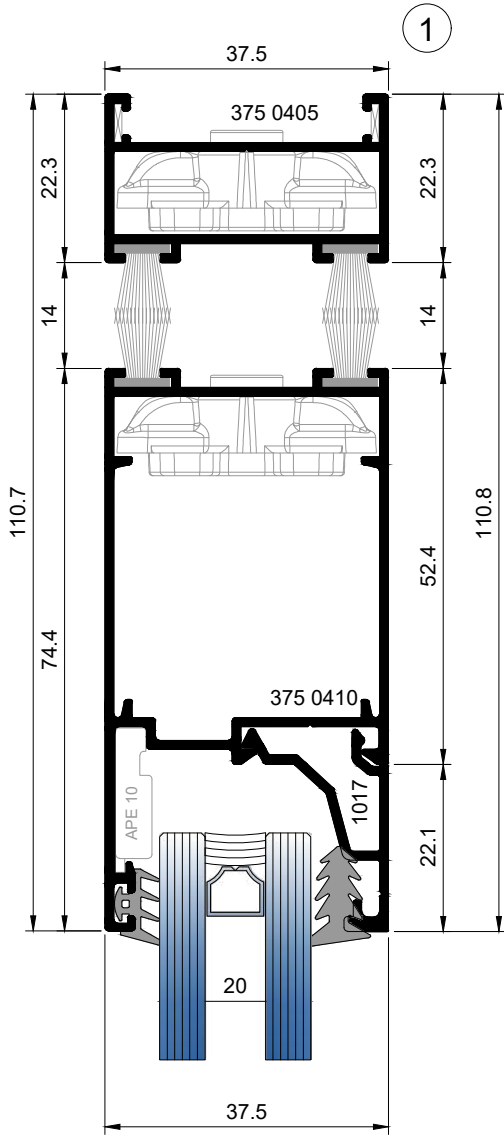

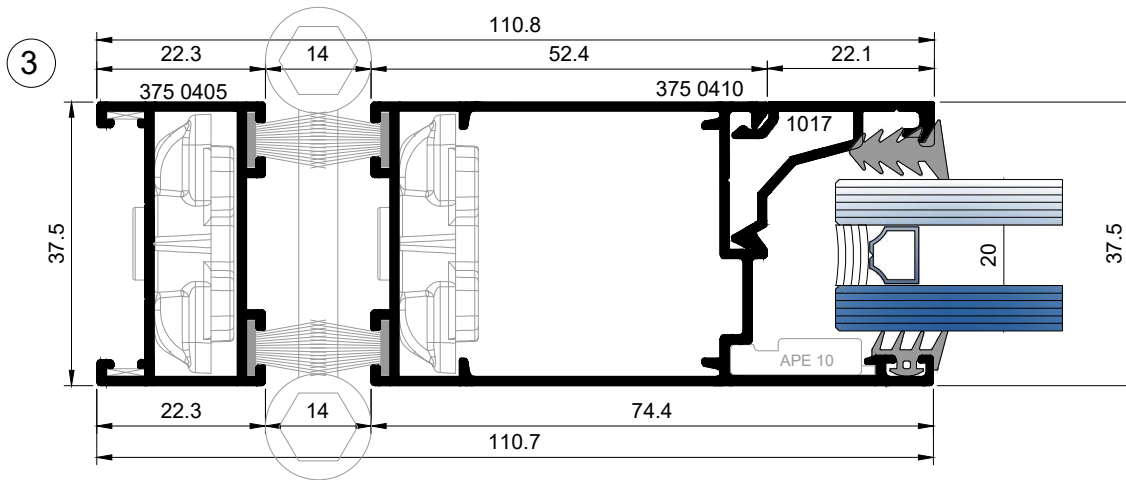
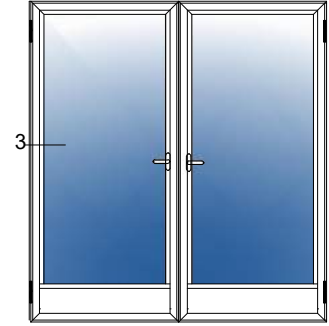

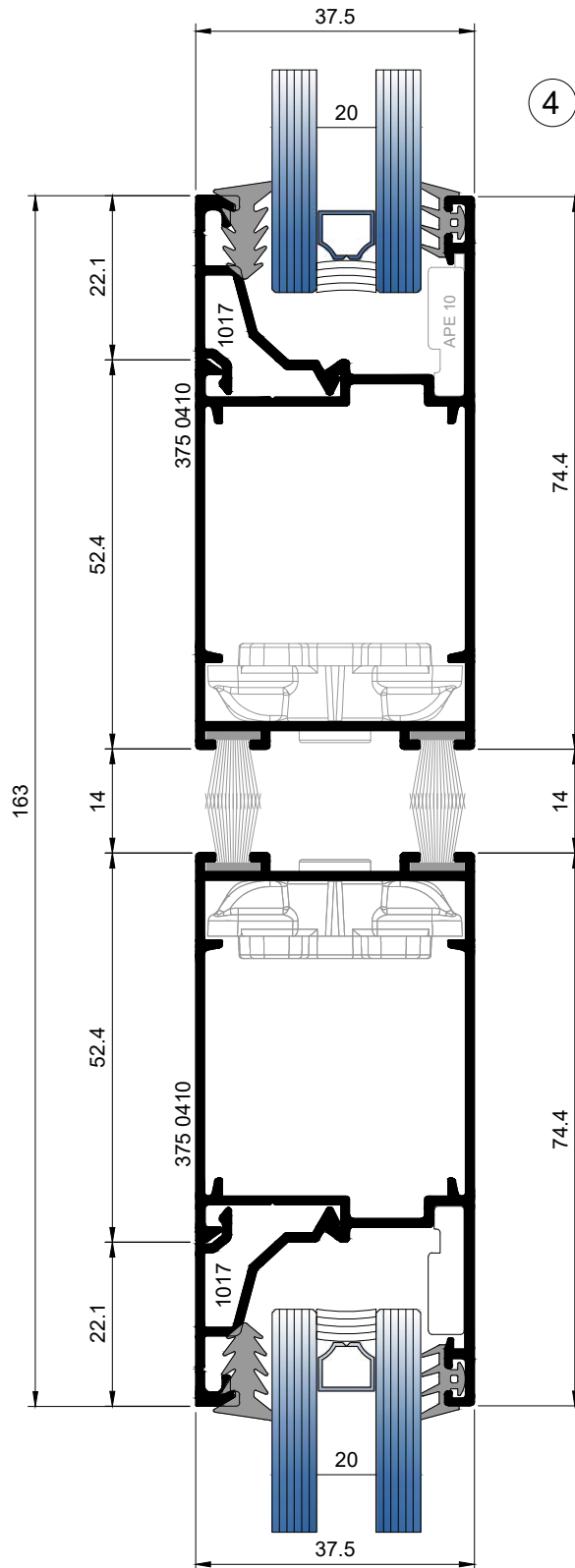
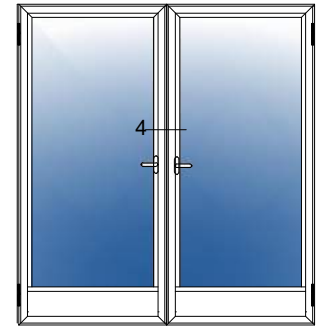

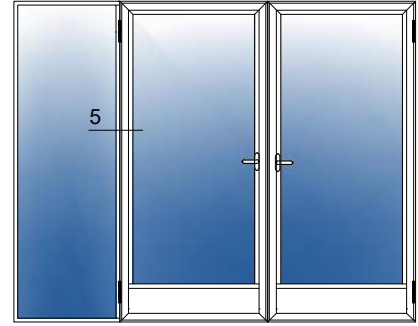
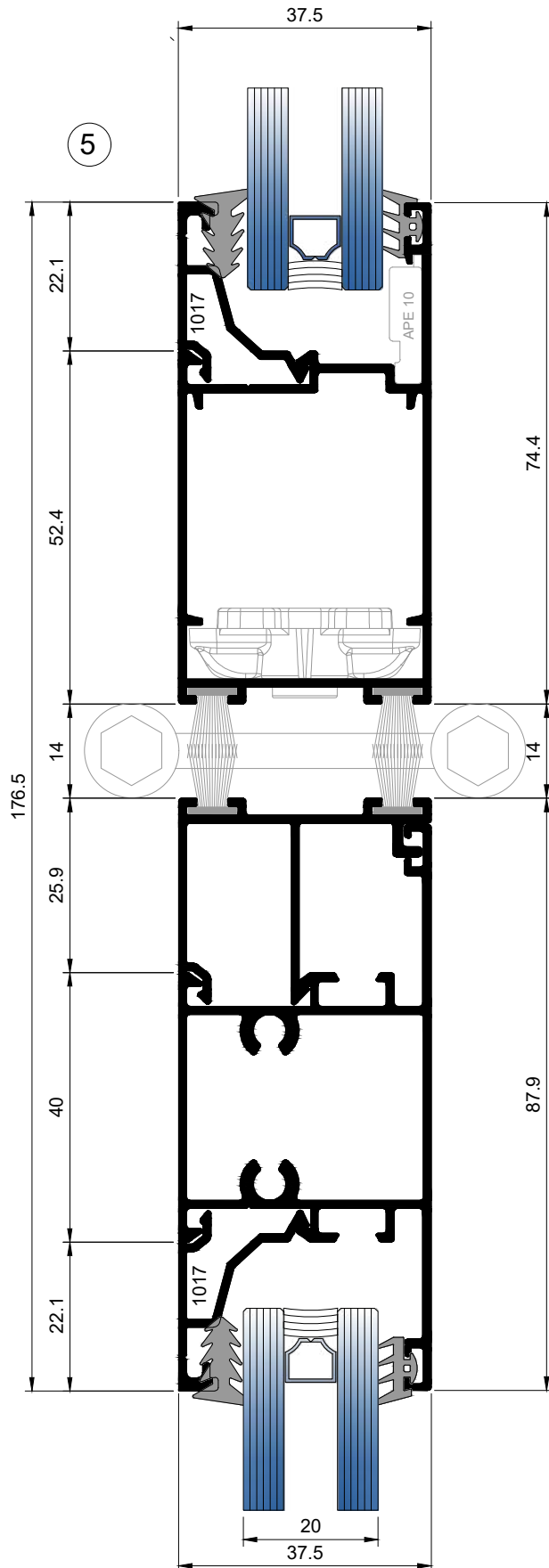

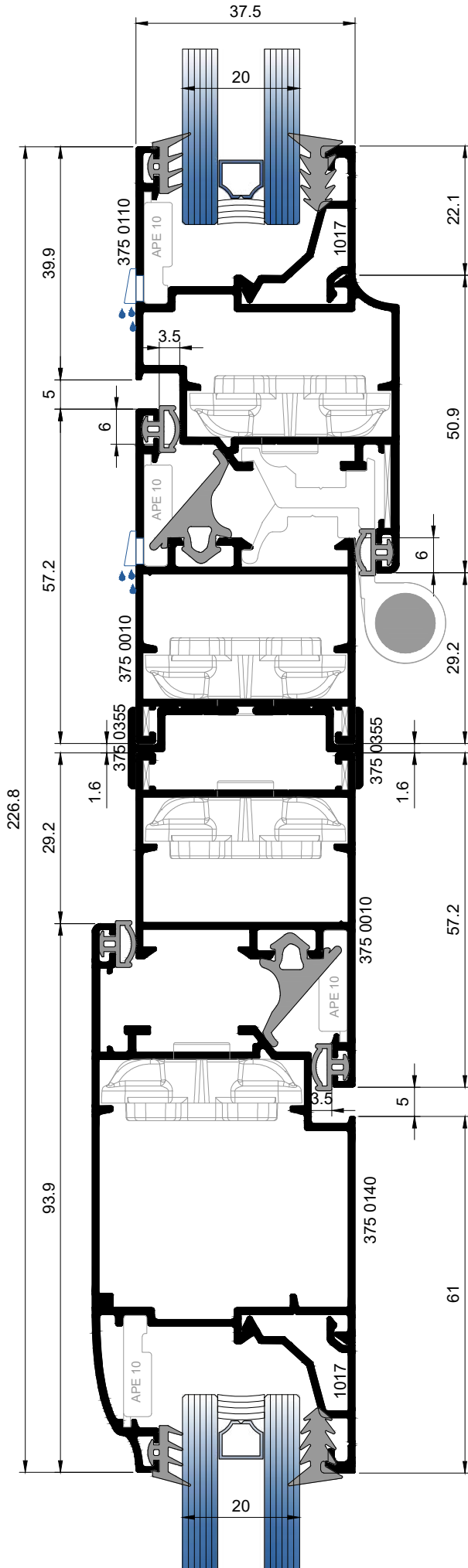

1

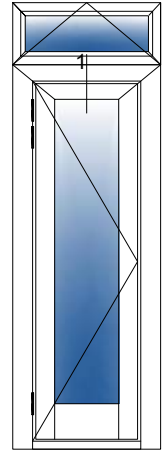

outwards opening door

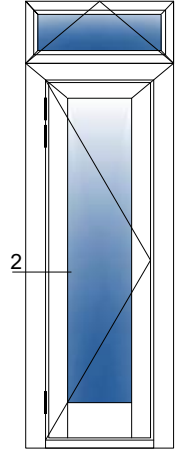

outwards opening  
door

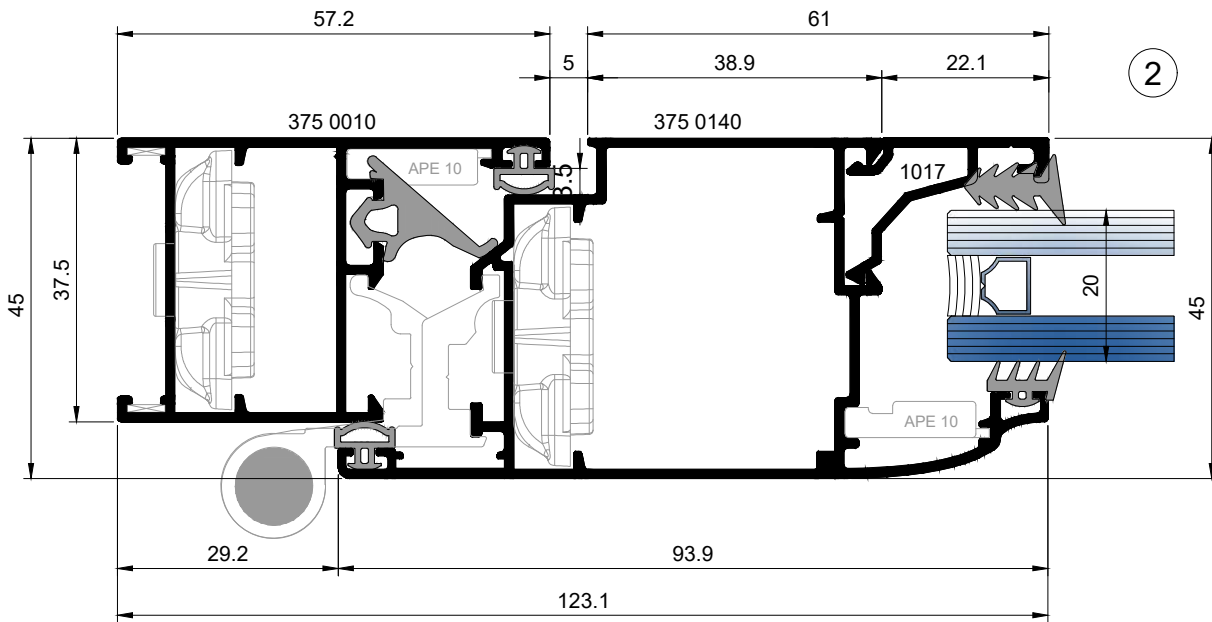

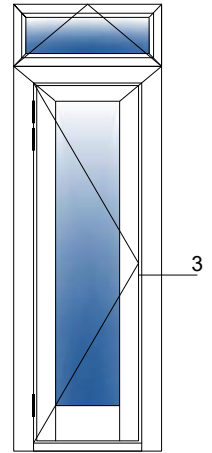

outwards opening  
door

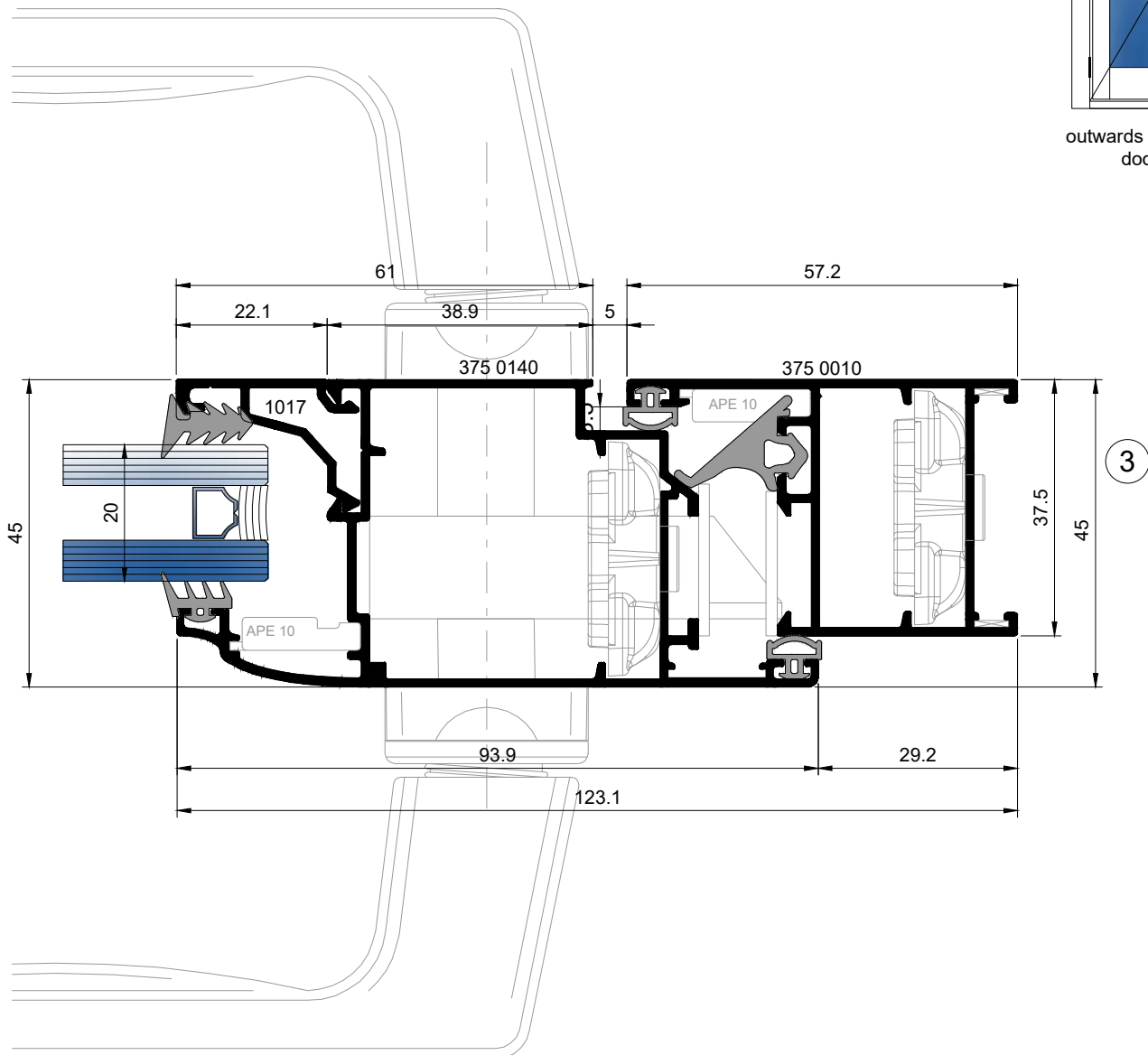

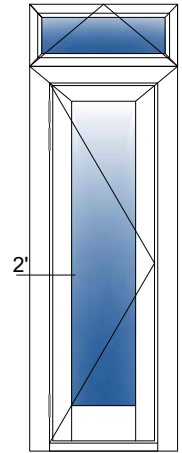

outwards opening door

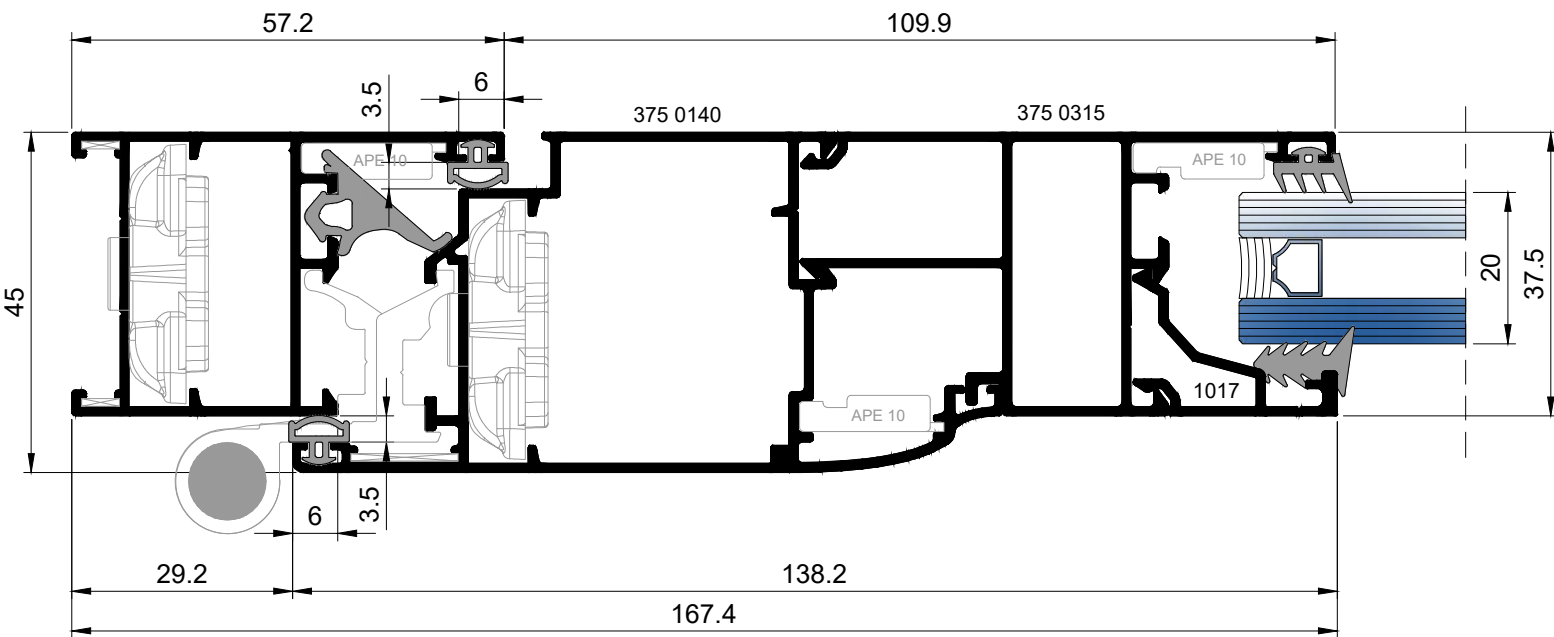



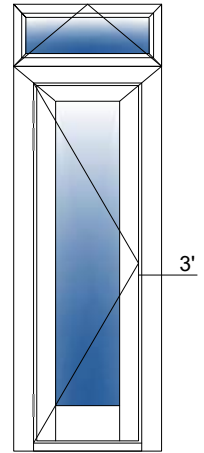

outwards opening door

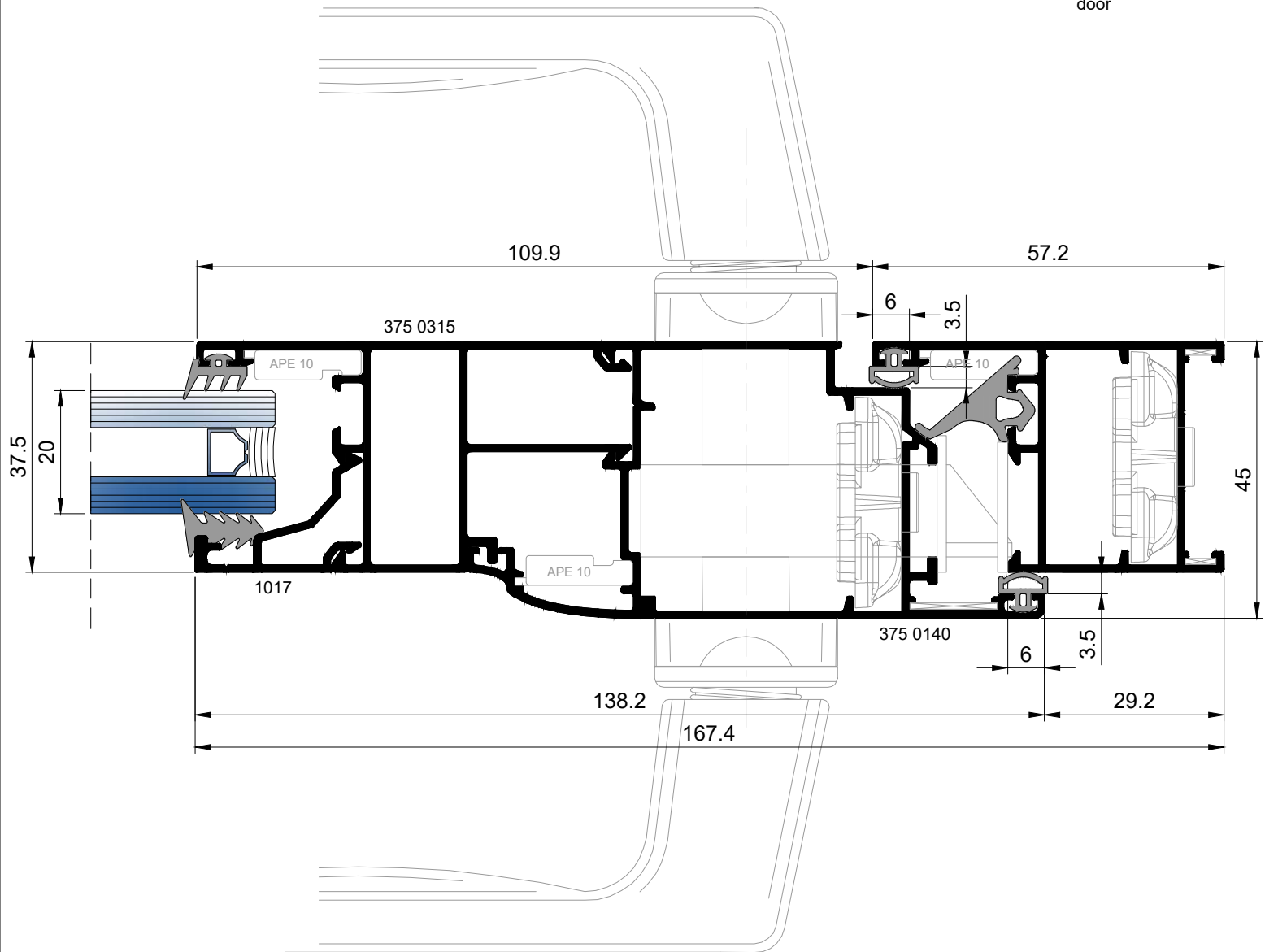

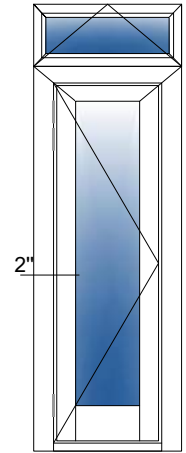

outwards opening door

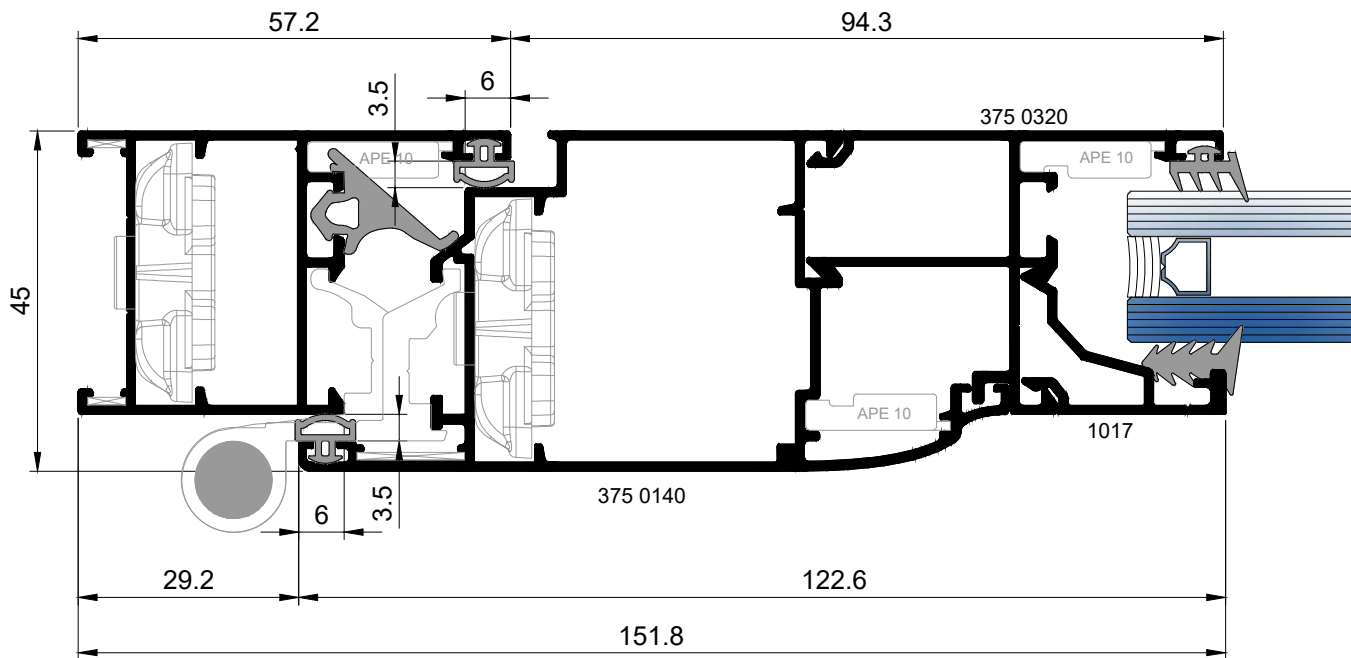

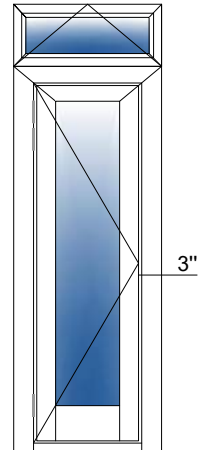

outwards opening door

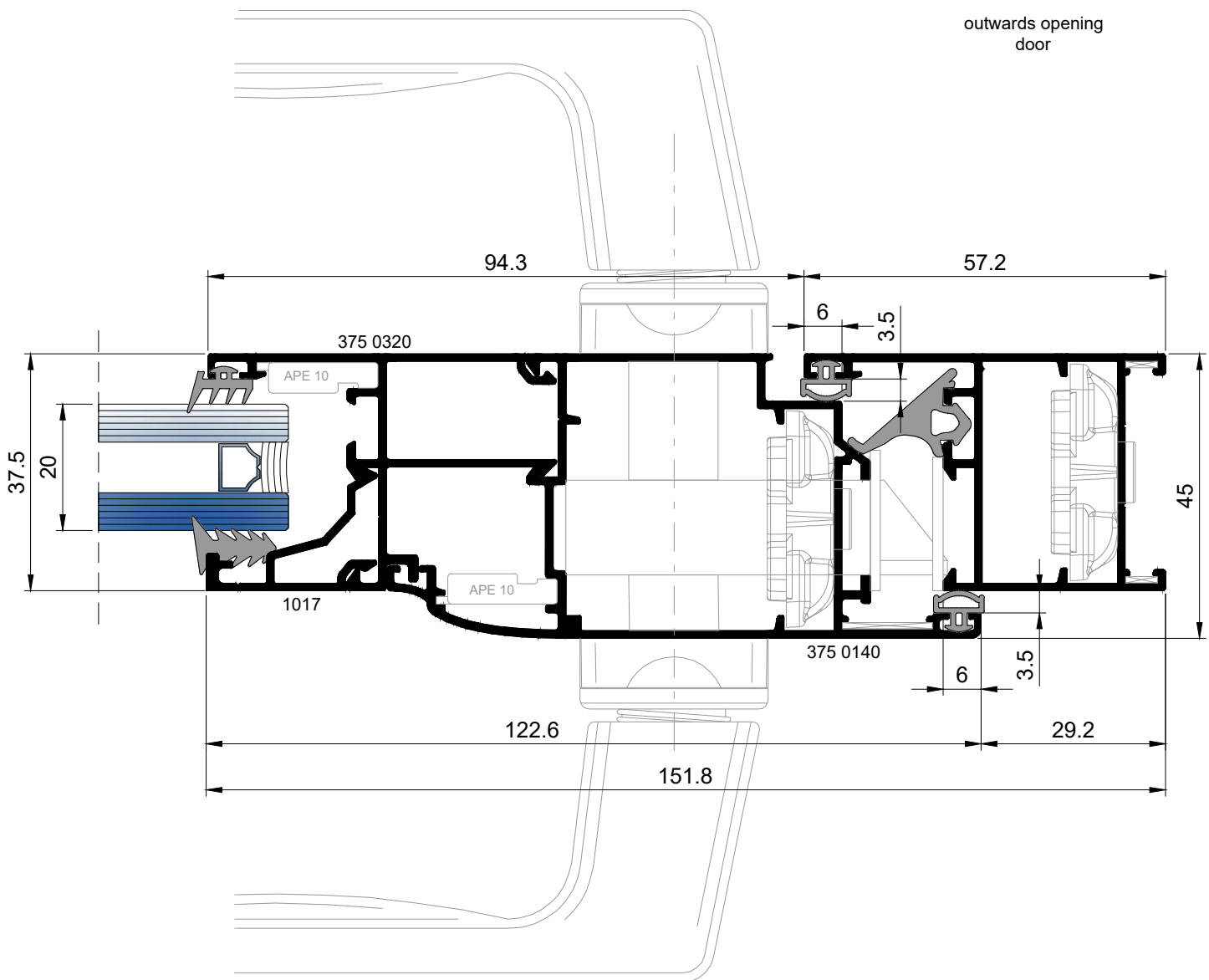

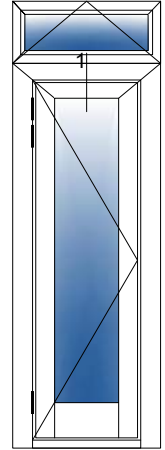
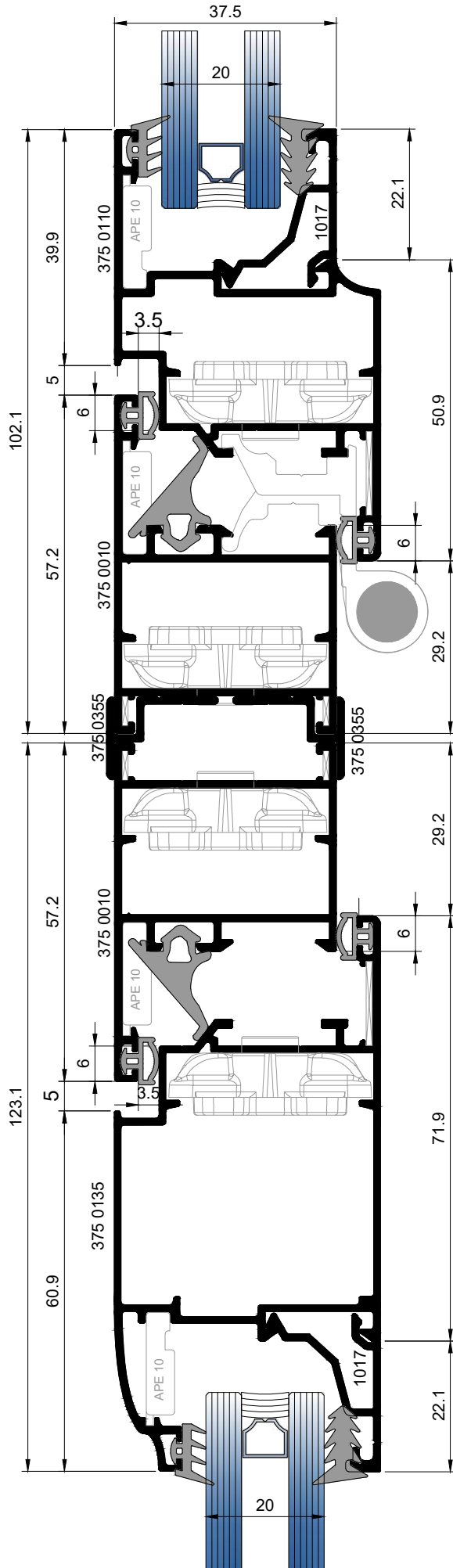

inwards opening door

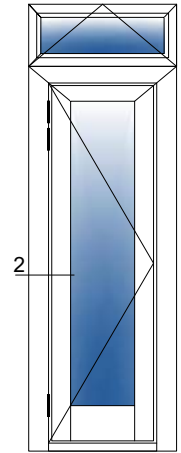

inwards opening door

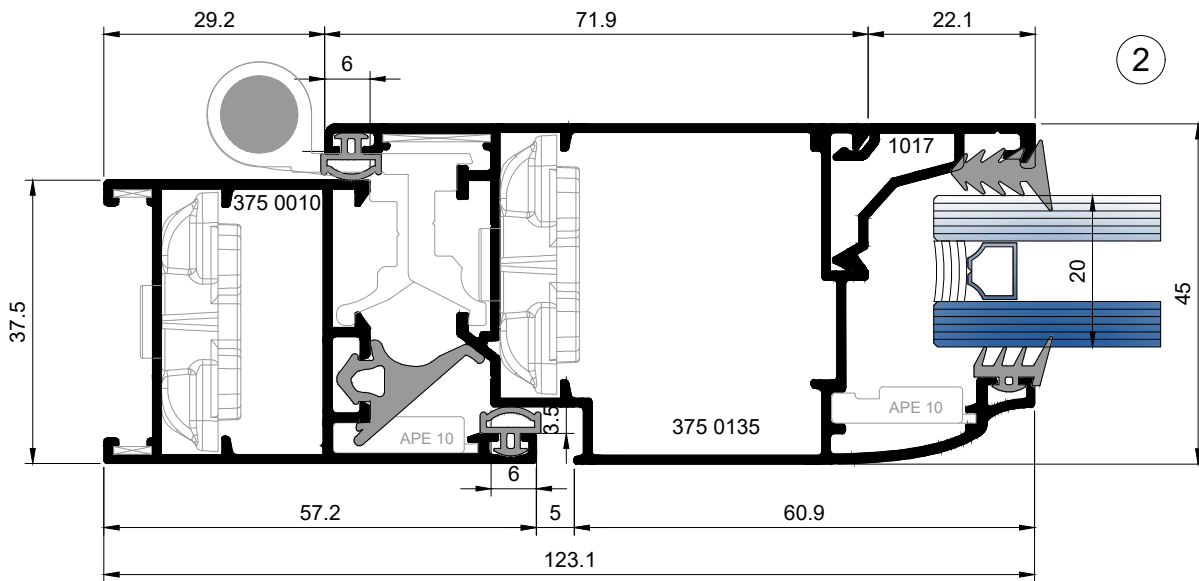

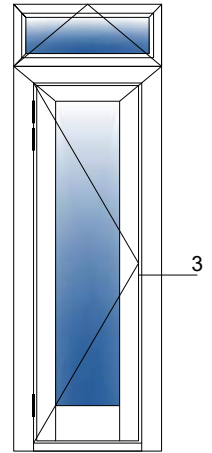

inwards opening door

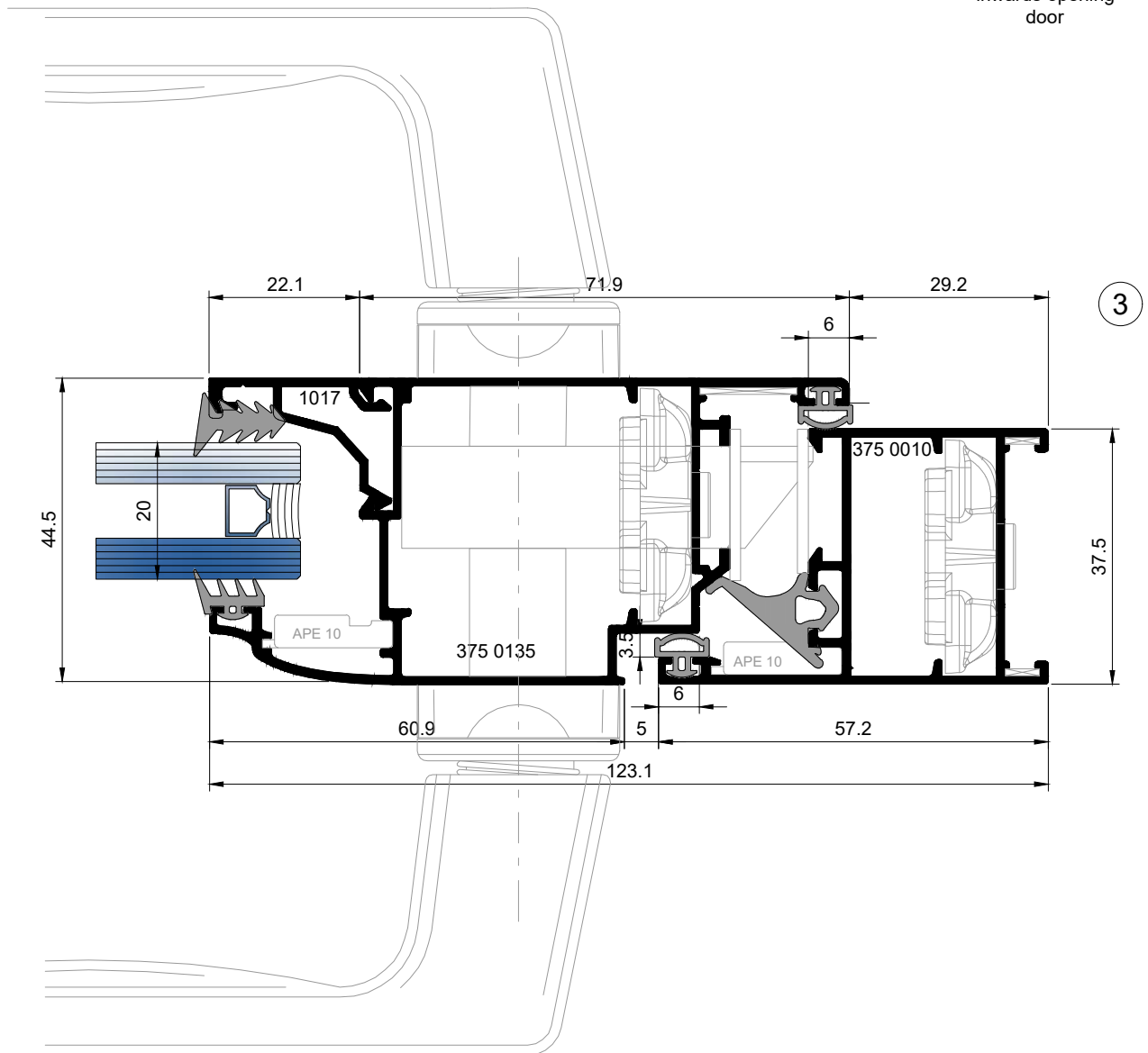

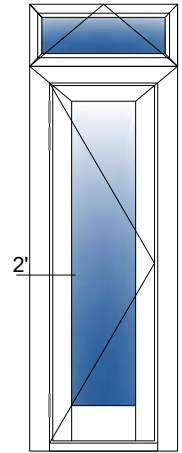

outwards opening door

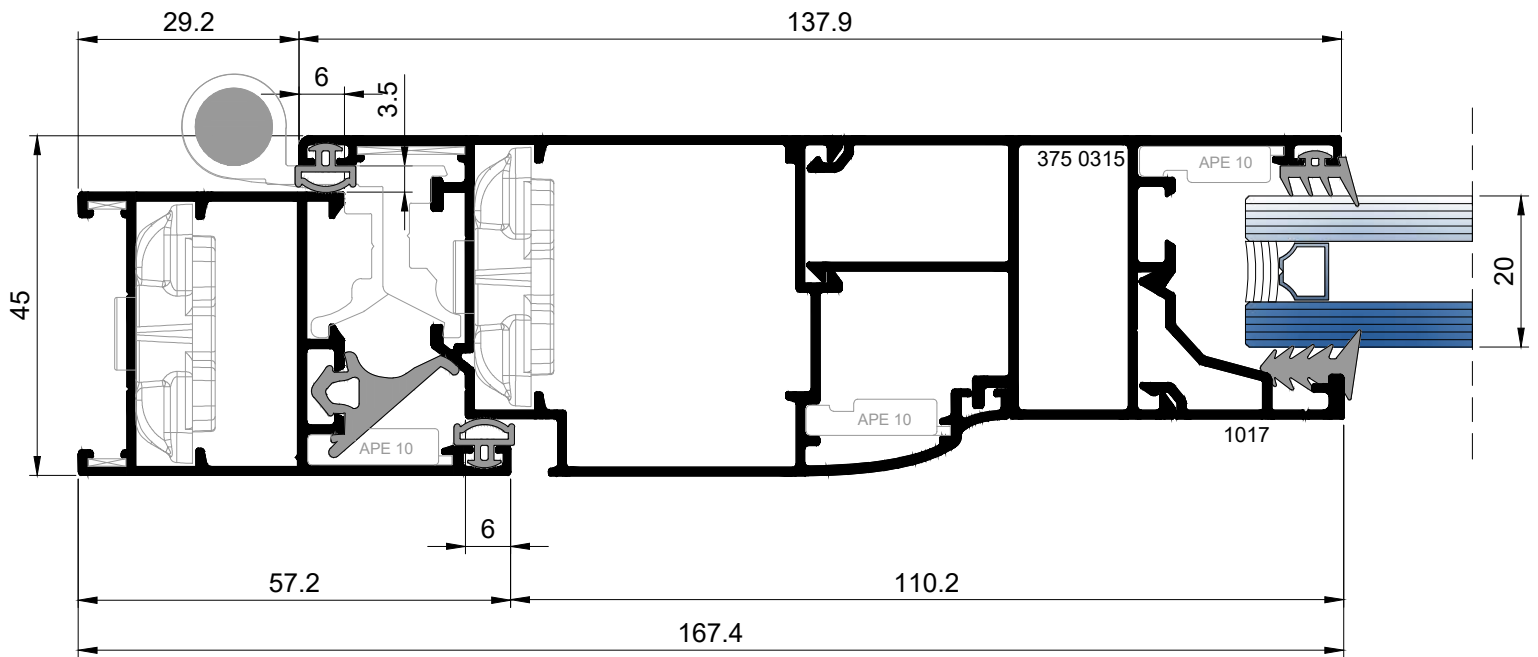

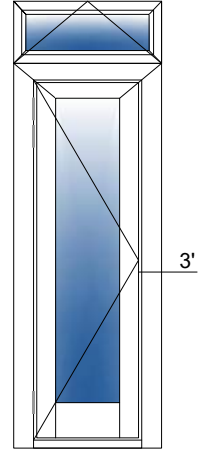

outwards opening  
door

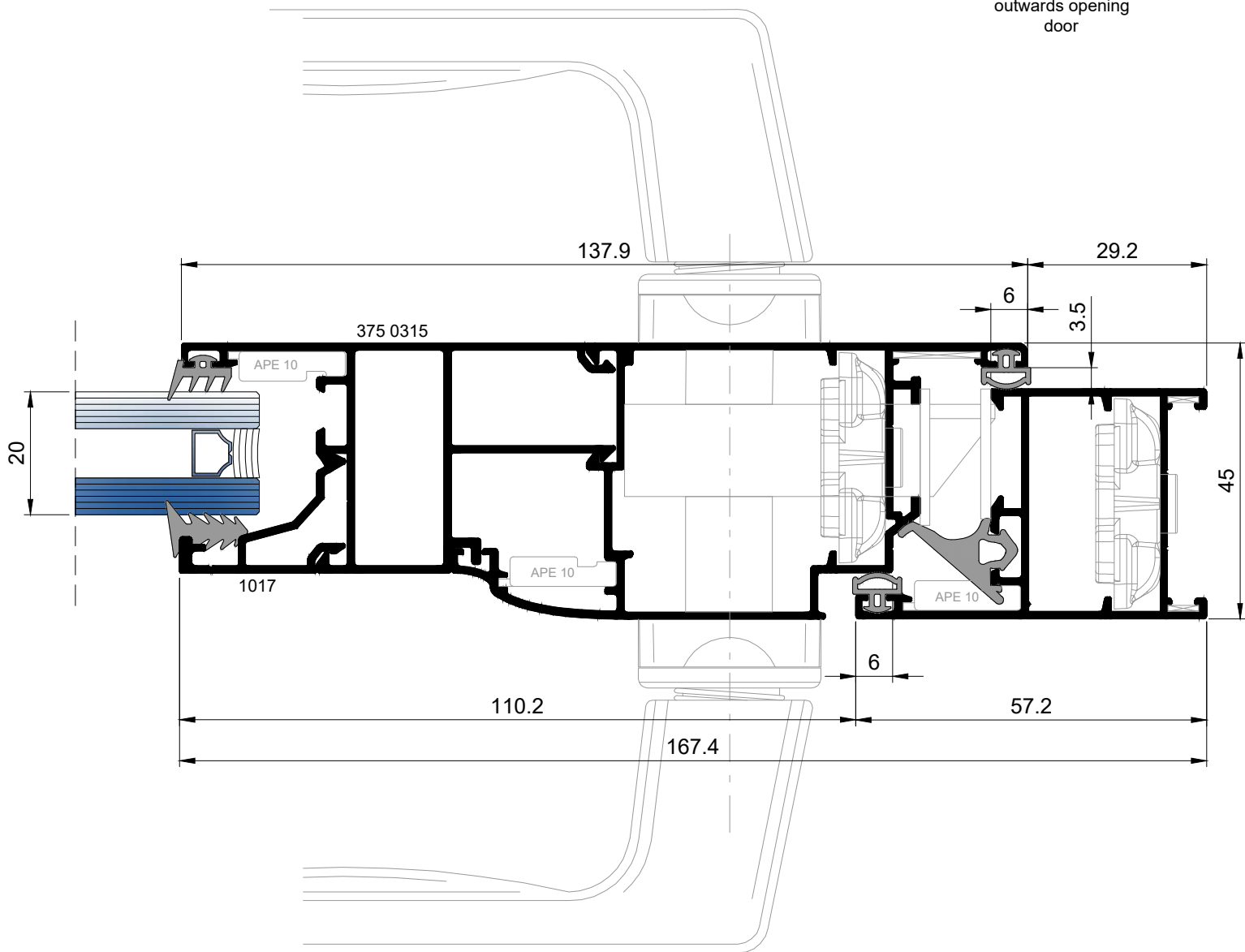



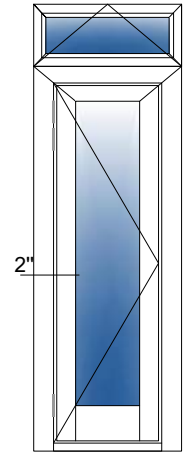

outwards opening door

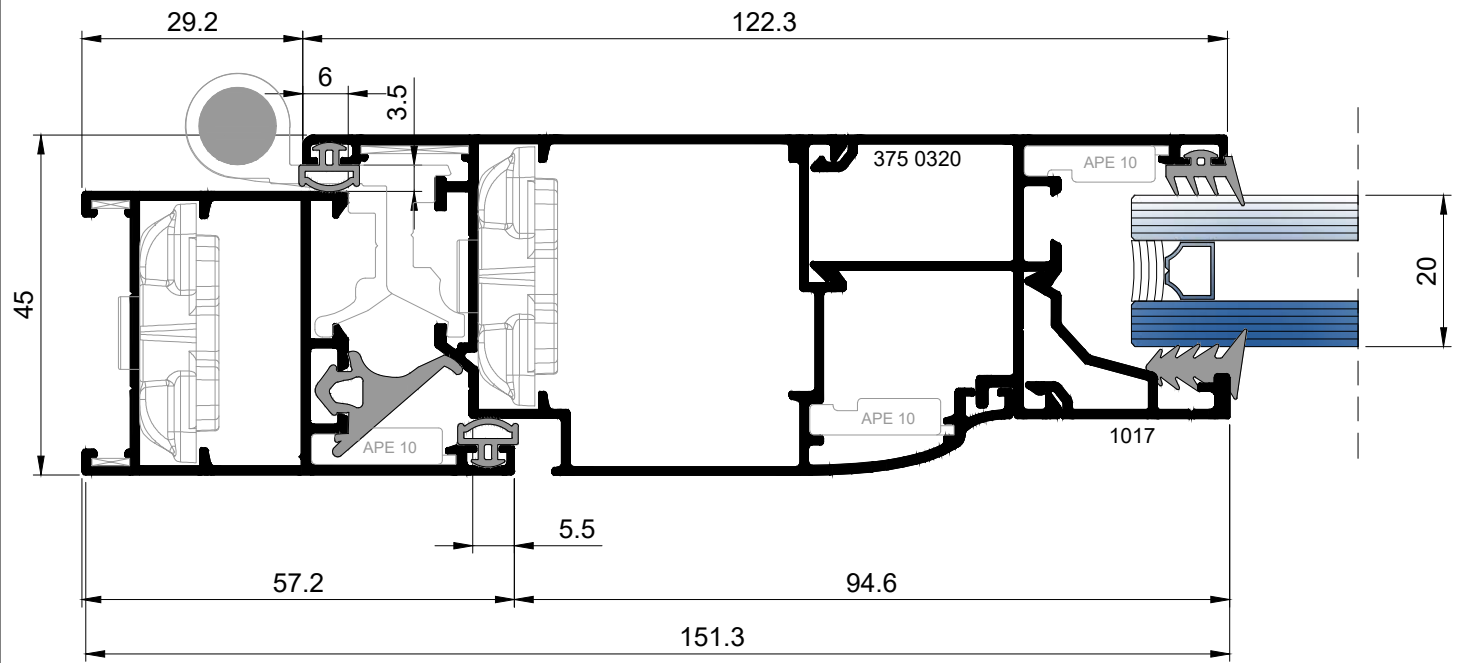

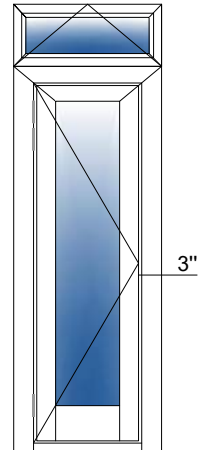

outwards opening door

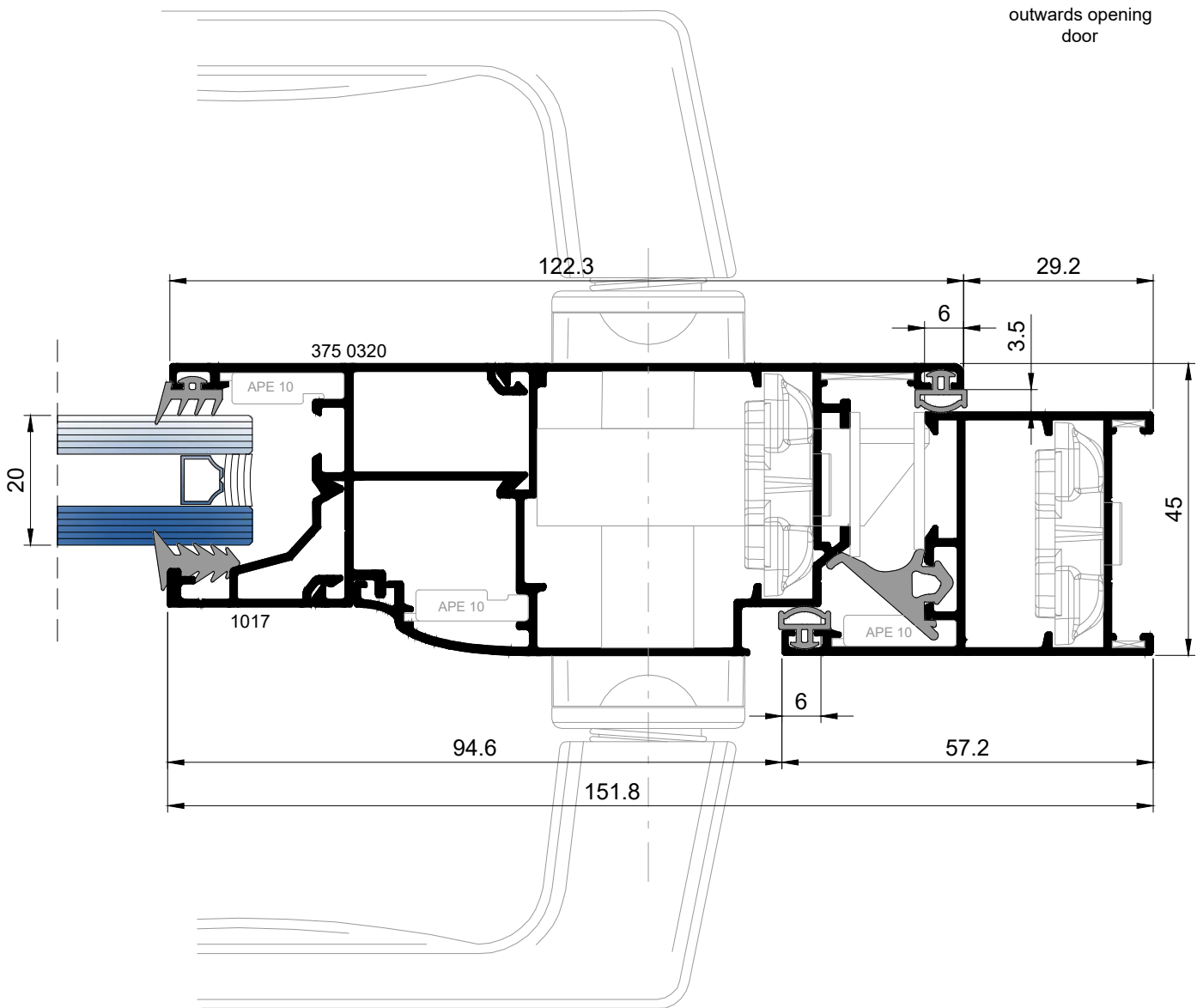

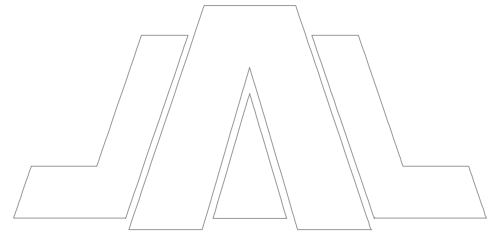

# **CUTTING ANALYSIS**

PROFILES		
FRAME	2pcs=B	
	2pcs=H	
SASH	2pcs=B-37.6 mm	
	2pcs=H-37.6 mm	
For frames: 375 0005, 375 0006, 375 0020, 375 0040, 375 0050		
GLASSHOLDER	2pcs=B-118.4 mm	
	2pcs=H-162.4 mm	
For frames: 375 0005, 375 0006, 375 0020, 375 0040, 375 0050		
For sashes: 375 0105, 375 0125, 375 0126		
GLASS	Glass width	BG=B-133.4 mm
	Glass height	HG=H-133.4 mm

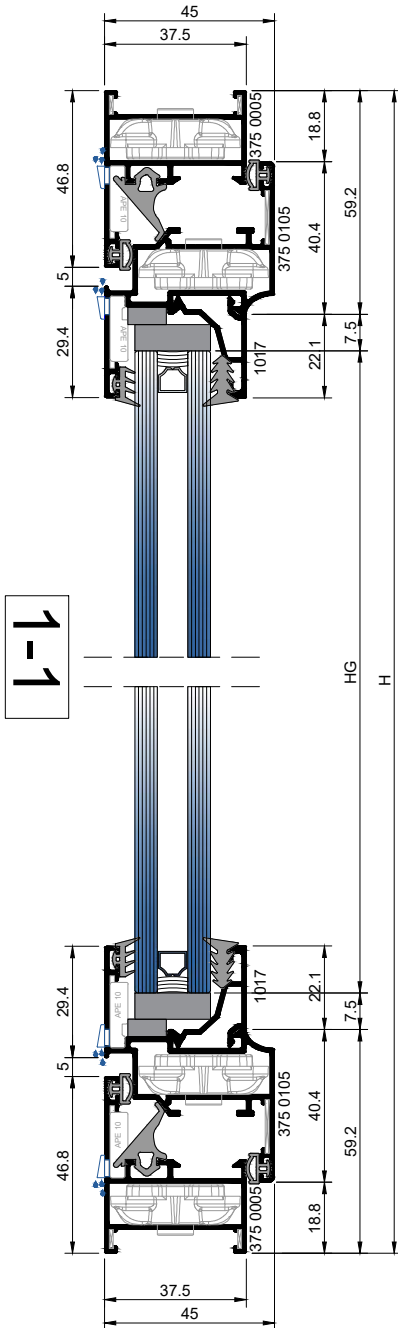
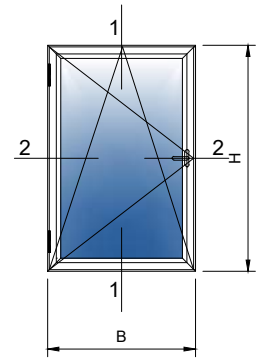

2-2

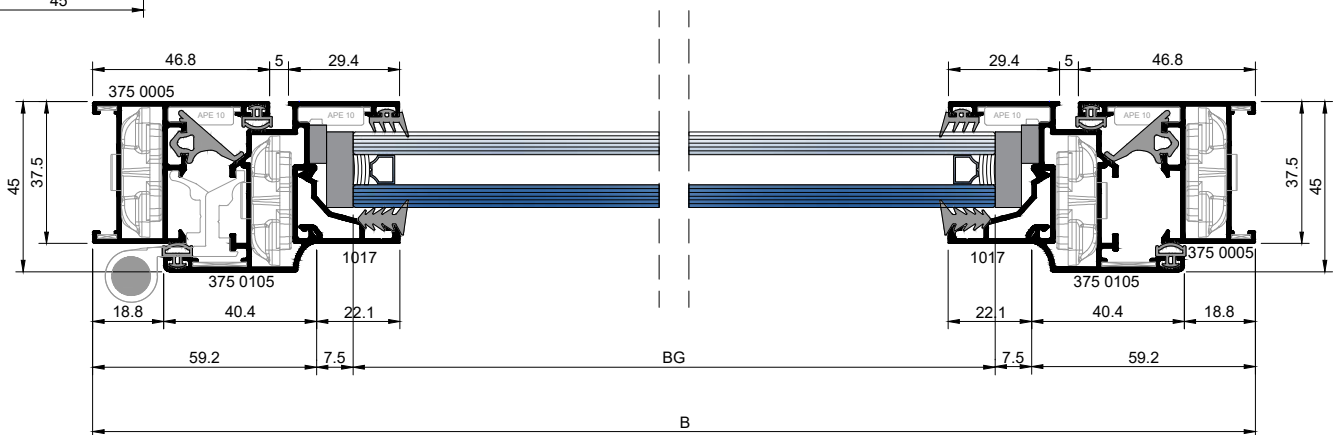

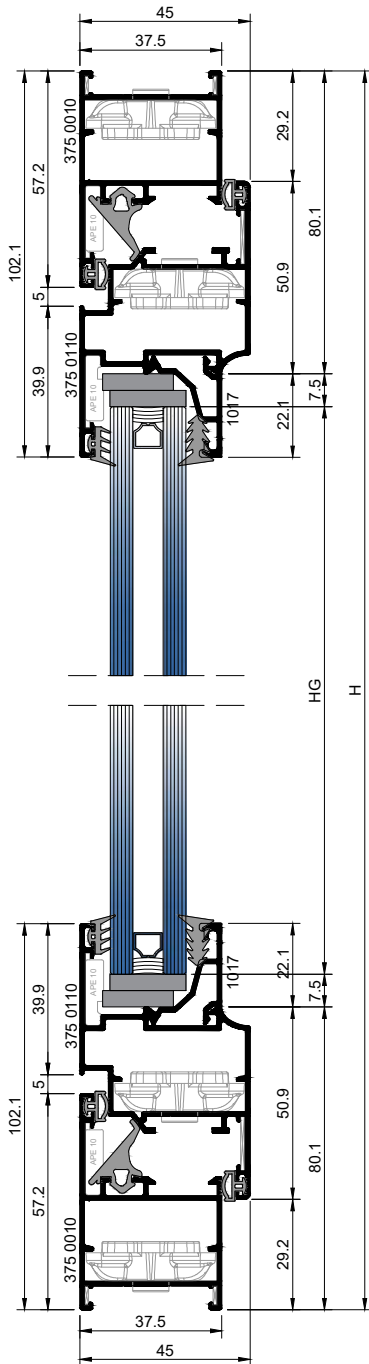

1-1

PROFILES		
FRAME	2pcs=B	
	2pcs=H	
SASH	2pcs=B-58.4 mm	
	2pcs=H-58.4 mm	
For frames: 375 0010, 375 0035, 375 0045, 375 0055		
GLASSHOLDER	2pcs=B-160.2 mm	
	2pcs=H-204.2 mm	
For frames: 375 0010, 375 0035, 375 0045, 375 0055		
For sashes: 375 0110, 375 0130		
GLASS	Glass width	BG=B-175.2 mm
	Glass height	HG=H-175.2 mm

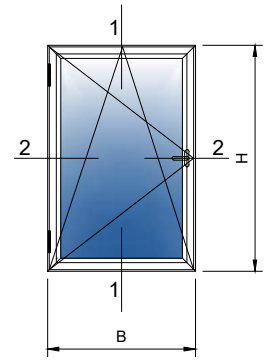

2-2

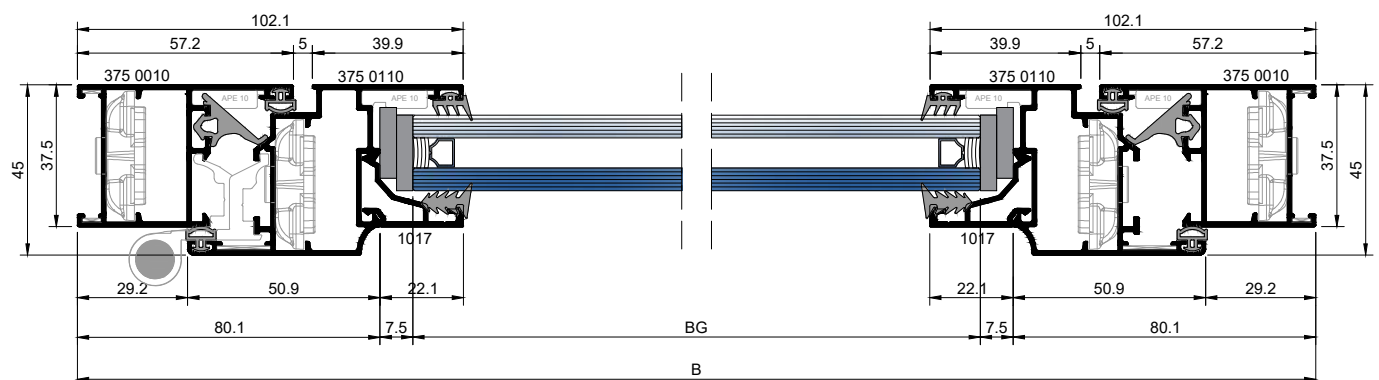

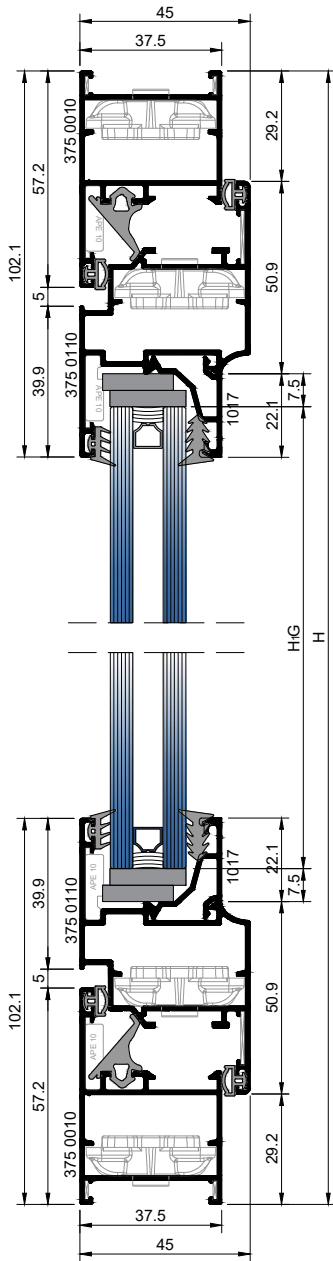

PROFILES		
FRAME	2pcs=B	
	2pcs=H	
SASH	2pcs=B <sub>r</sub> -37.7 mm*	* Only for 375 0210
	2pcs=H-58.4 mm	
For frames: 375 0010, 375 0035, 375 0045, 375 0055		
GLASSHOLDER	2pcs=B <sub>r</sub> -139.5 mm*	* Only for 375 0210
	2pcs=H-204.2 mm	
	2pcs=B <sub>2</sub> -49.7 mm*	* Only for 375 0210
	2pcs=H-114.4 mm	
For frames: 375 0010, 375 0035, 375 0045, 375 0055		
For sashes: 375 0110, 375 0130		
GLASS	Glass width	B <sub>1</sub> G=B <sub>r</sub> -154.5 mm
		B <sub>2</sub> G=B <sub>2</sub> -64.7 mm
	Glass height	H <sub>1</sub> G=H-175.2 mm
		H <sub>2</sub> G=H-85.4 mm

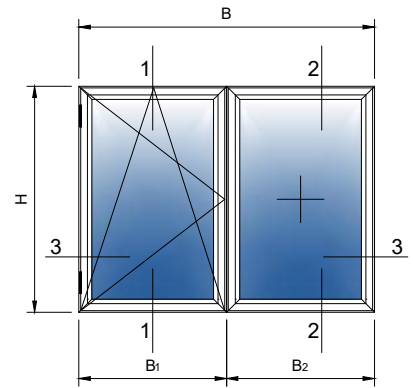

1-1

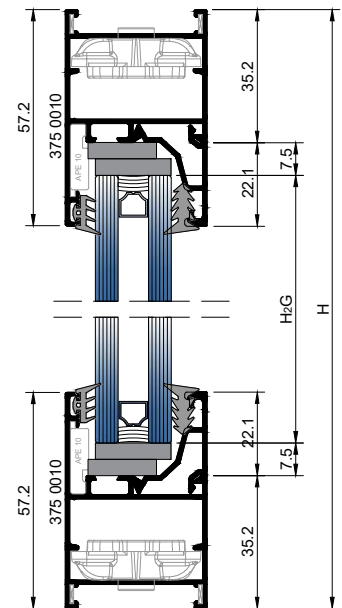

2-2

3-3

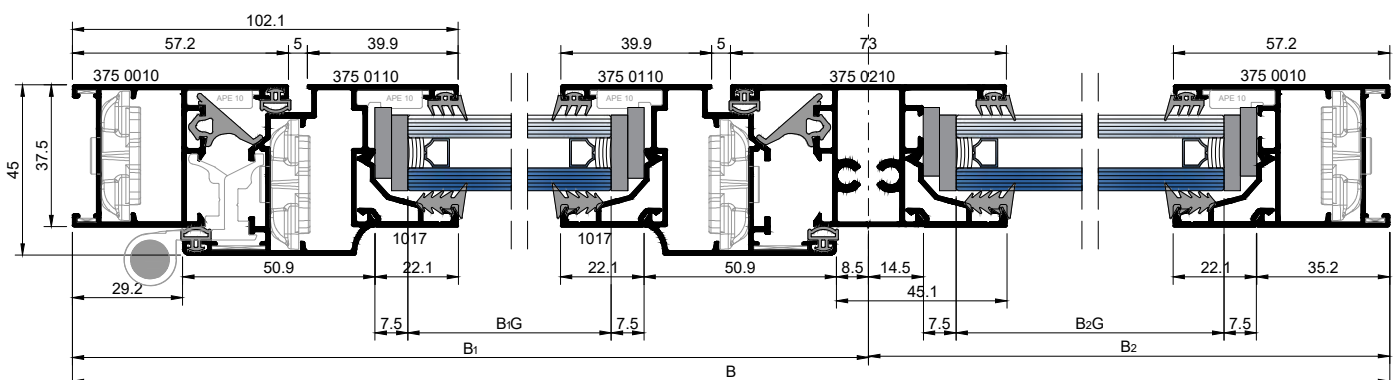

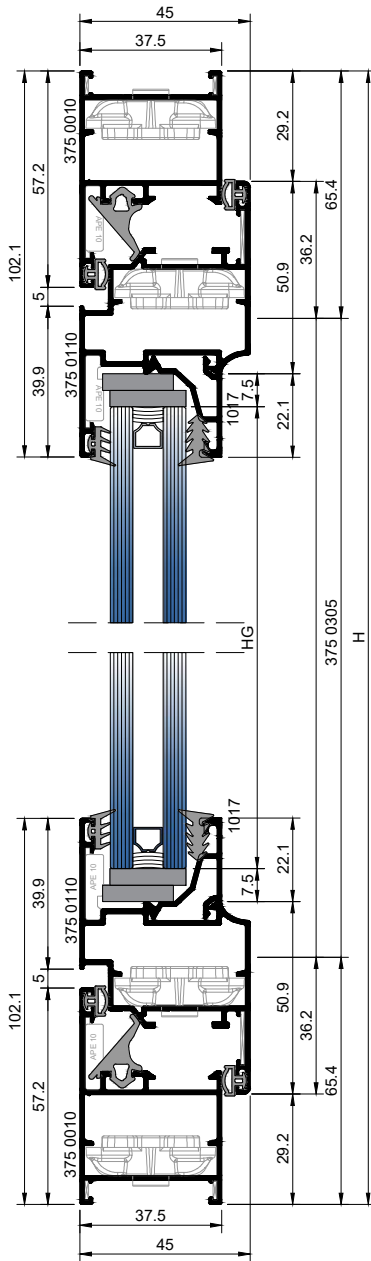

1-1

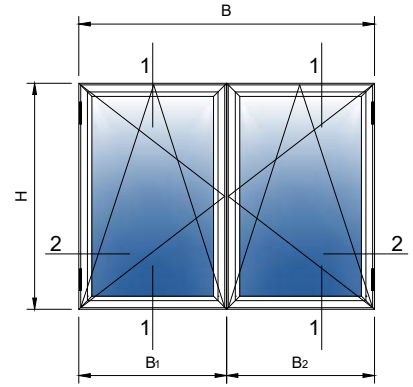

PROFILES		
FRAME	2pcs=B	
	2pcs=H	
SASH	2pcs=B <sub>1</sub> -31.7 mm*	* also for 375 0310
	2pcs=B <sub>2</sub> -31.7 mm*	* also for 375 0310
	4pcs=H-58.4 mm	
For frames:375 0010, 375 0035,375 0045,375 0055		
GLASSHOLDER	2pcs=B <sub>1</sub> -133.5 mm*	* also for 375 0310
	4pcs=H-204.2 mm	
	2pcs=B <sub>2</sub> -133.5mm*	* also for 375 0310
For frames:375 0010, 375 0035,375 0045,375 0055 For sashes:375 0110,375 0130		
OVERHUNG	1pcs=H-130.8 mm*	* also for 375 0310
For frames:375 0010, 375 0035,375 0045,375 0055		
GLASS	Glass width	B <sub>1</sub> G=B <sub>1</sub> -148.5 mm
		B <sub>2</sub> G=B <sub>2</sub> -148.5 mm
	Glass height	HG=H-175.2 mm

2-2

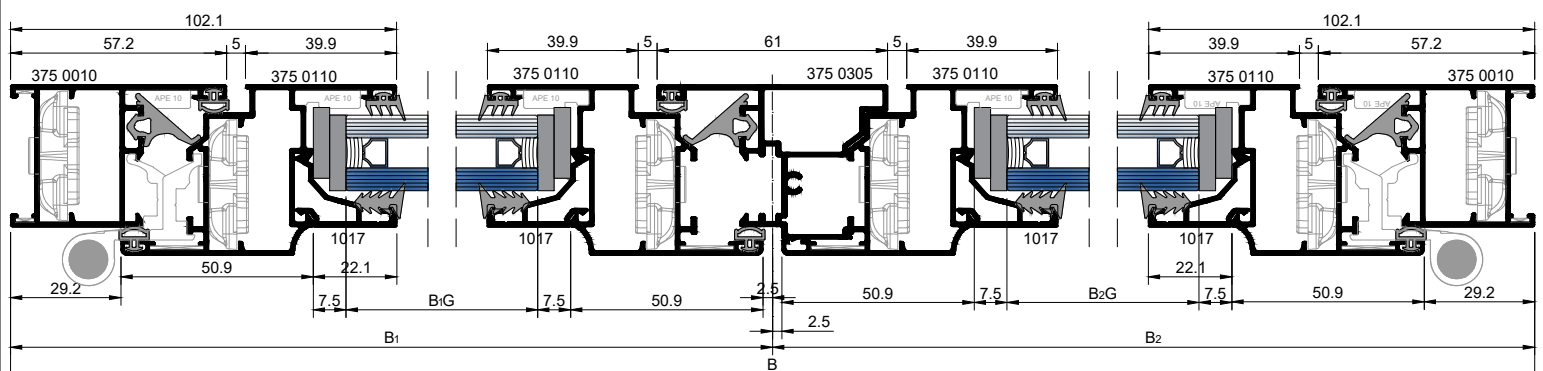

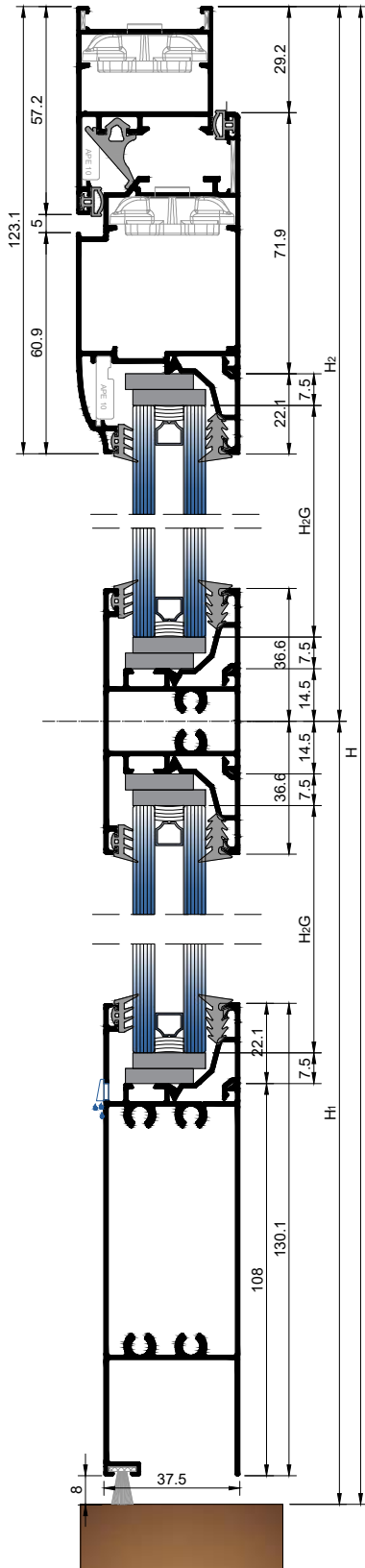

1-1

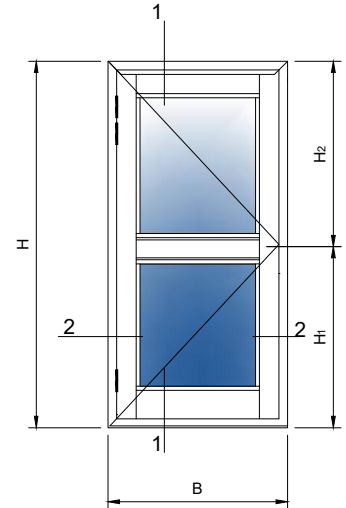

PROFILES		
FRAME	1pcs=B	
	2pcs=H	
SASH	1pcs=B-58.4 mm	
	2pcs=H-37.2 mm	
For frames: 375 0010, 375 0035, 375 0045, 375 0055		
GLASSHOLDER	4pcs=B-202.2 mm	
	2pcs=H <sub>1</sub> -174.7 mm*	*only for 375 0210
	2pcs=H <sub>2</sub> -159.8 mm	
For frames: 375 0010, 375 0035, 375 0045, 375 0055		
MULLION	1pcs=B-202.2 mm	
BOARD FOR DOOR	1pcs=B-202.2 mm	
For frames: 375 0010, 375 0035, 375 0045, 375 0055		
GLASS	Glass width	BG=B-217.2mm
	Glass height	H <sub>1</sub> G=H <sub>1</sub> -145.5 mm
		H <sub>2</sub> G=H <sub>2</sub> -130.6 mm

2-2

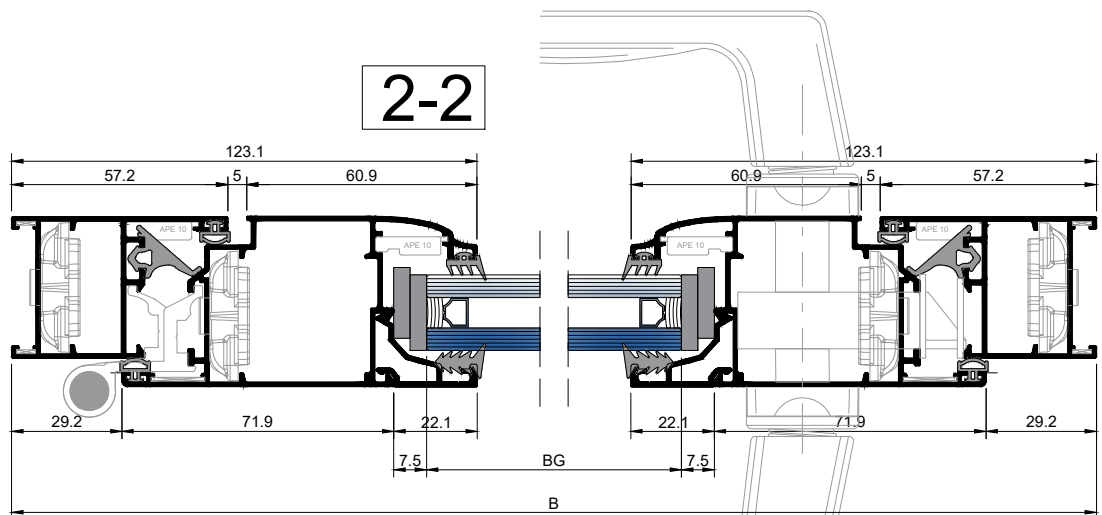



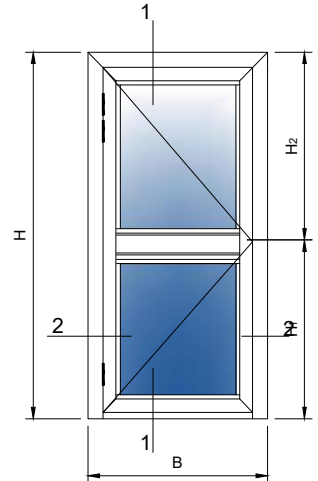
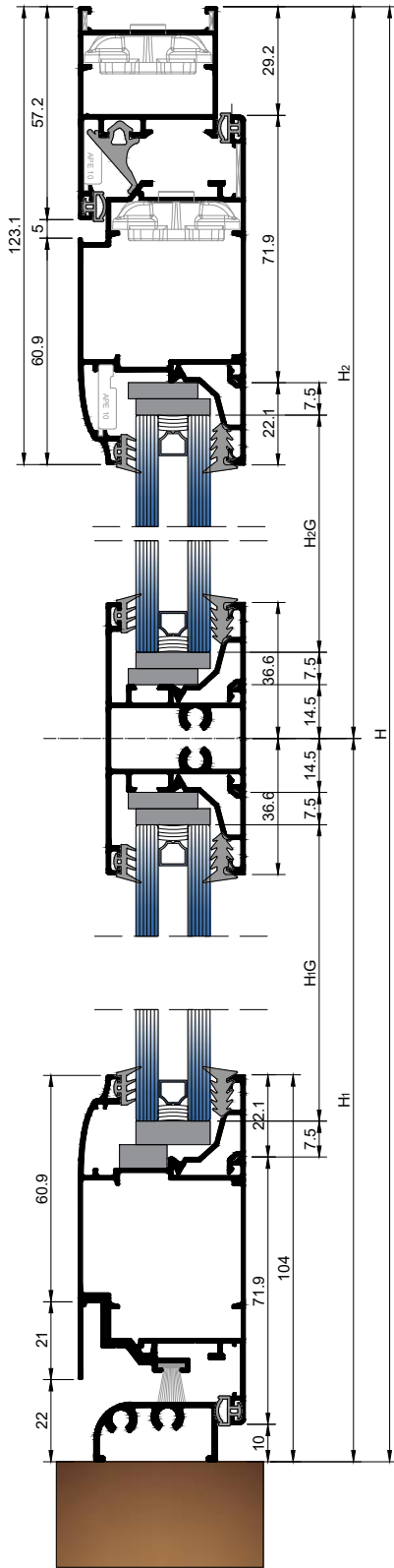

PROFILES		
FRAME	1pcs=B	
	2pcs=H	
SASH	2pcs=B-58.4 mm	
	2pcs=H-39.2 mm	
<b>For frames:</b> 375 0010, 375 0035, 375 0045, 375 0055		
GLASSHOLDER	4pcs=B-202.2 mm	
	2pcs=H <sub>r</sub> -140.6 mm*	*only for 375 0210
	2pcs=H <sub>2</sub> -159.8 mm	
<b>For frames:</b> 375 0010, 375 0035, 375 0045, 375 0055		
MULLION	1pcs=B-202.2 mm	
<b>For frames:</b> 375 0010, 375 0035, 375 0045, 375 0055		
ADDITION FOR DOOR	1pcs=B-124.4 mm	375 0360
<b>For frames:</b> 375 0010, 375 0035, 375 0045, 375 0055		
DOOR-SILL	1pcs=B-58.4 mm	375 0365 without cap
<b>For frames:</b> 375 0010, 375 0035, 375 0045, 375 0055		
GLASS	Glass width	BG=B-217.2mm
	Glass height	H <sub>r</sub> G=H <sub>r</sub> -111.4 mm
		H <sub>2</sub> G=H <sub>2</sub> -130.6 mm

2-2

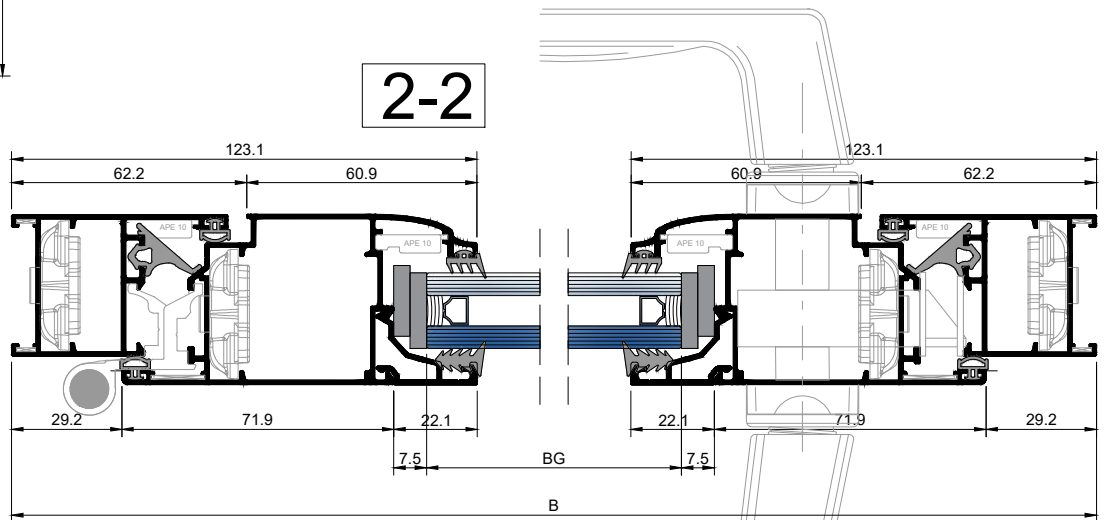

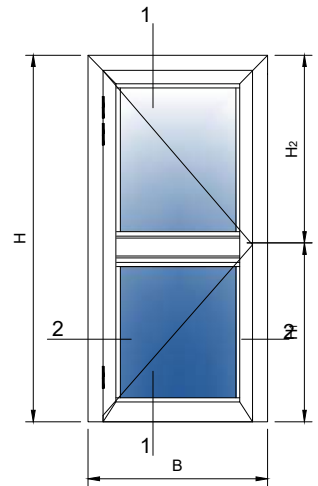
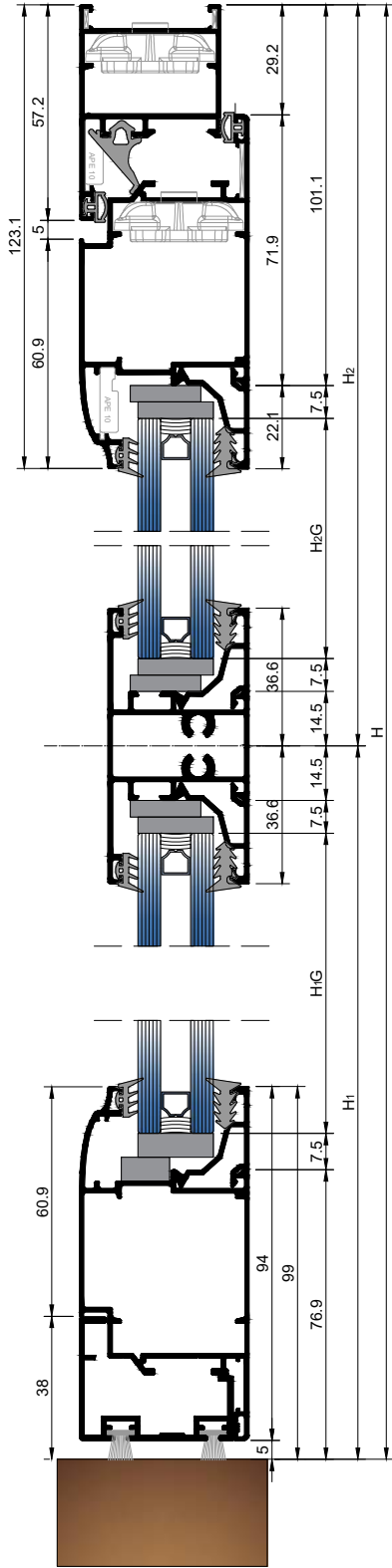

PROFILES		
FRAME	1pcs=B	
	2pcs=H	
SASH	2pcs=B-58.4 mm	
	2pcs=H-34.2 mm	
For frames: 375 0010, 375 0035, 375 0045, 375 0055		
GLASSHOLDER	4pcs=B-202.2 mm	
	2pcs=H <sub>1</sub> -135.6 mm*	*only for 375 0210
	2pcs=H <sub>2</sub> -159.8 mm	
For frames: 375 0010, 375 0035, 375 0045, 375 0055		
MULLION	1pcs=B-202.2 mm	
For frames: 375 0010, 375 0035, 375 0045, 375 0055		
ADDITION FOR DOOR	1pcs=B-124.4 mm	375 0361 without cap
For frames: 375 0010, 375 0035, 375 0045, 375 0055		
GLASS	Glass width	BG=B-217.2mm
	Glass height	H <sub>1</sub> G=H <sub>1</sub> -106.4 mm
		H <sub>2</sub> G=H <sub>2</sub> -130.6 mm

2-2

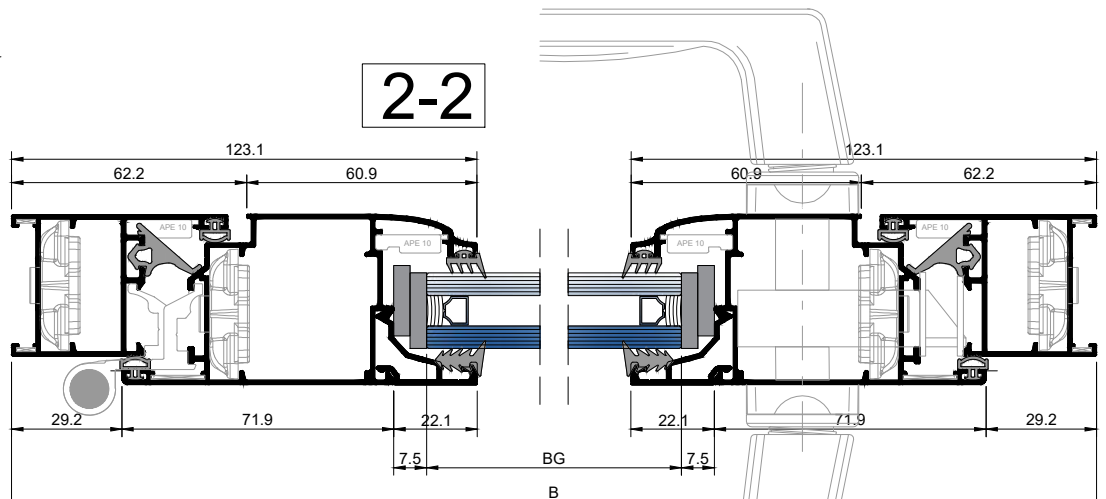

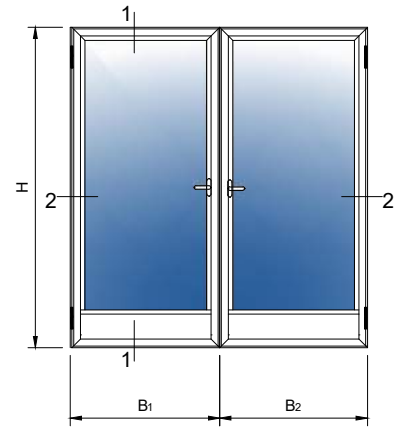
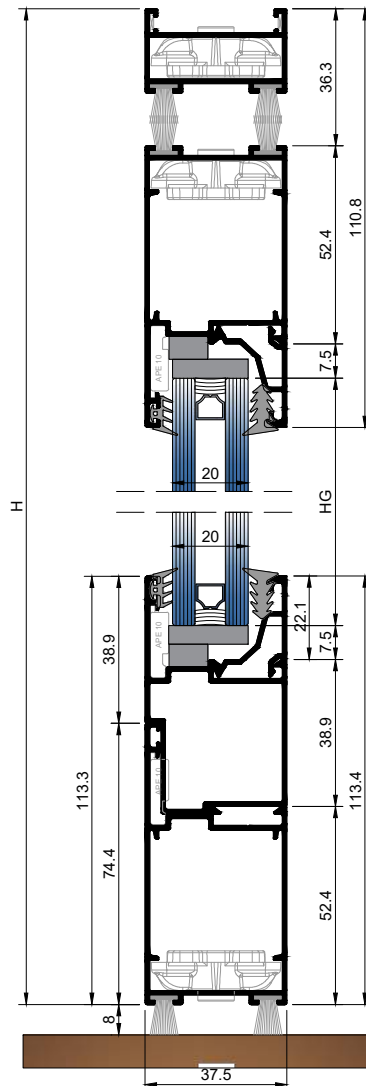
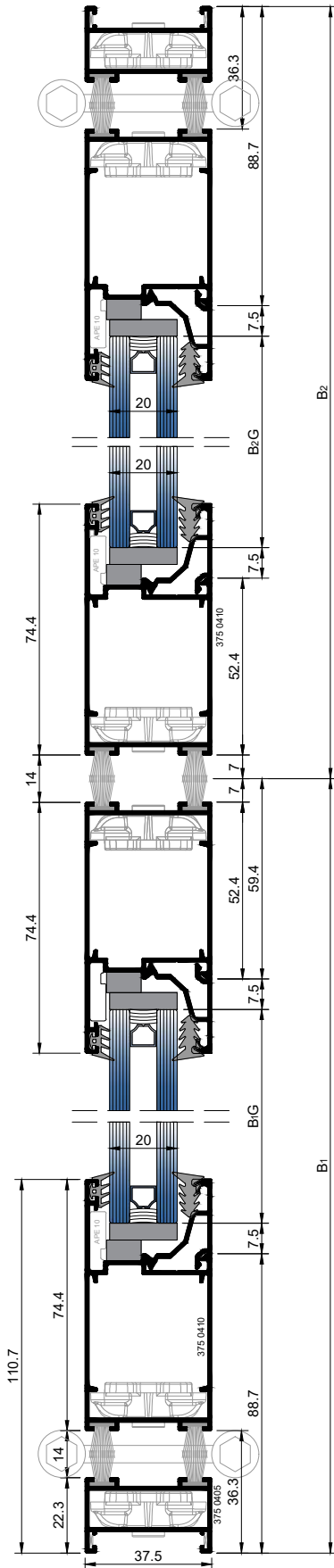

PROFILES		
FRAME	1pcs=B	
	2pcs=H	
SASH	2pcs=B <sub>1</sub> -43.3 mm	
	2pcs=B <sub>2</sub> -43.3 mm	
	4pcs=H-44.3 mm	
GLASSHOLDER	2pcs=B <sub>1</sub> -148.1mm	
	2pcs=B <sub>2</sub> -148.1 mm*	
	4pcs=H-244.2 mm	
ADDITION	2pcs=B <sub>1</sub> -148.1mm	
	2pcs=B <sub>2</sub> -148.1mm	
GLASS	Glass width	B <sub>1</sub> G=B <sub>1</sub> -163.1mm
		B <sub>2</sub> G=B <sub>2</sub> -163.1mm
	Glass height	HG=H-203 mm

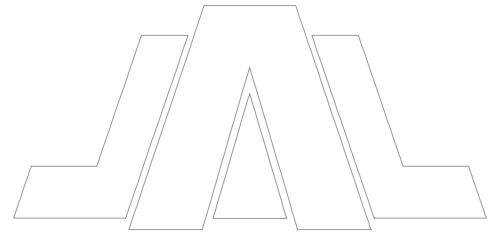

# 3D DETAILS

*press corners for crimping machine*

**APE 1030**  
Dimensions:  
70x10.3x34.8

**APE 1031**  
Dimensions:  
70x10.3x30.6

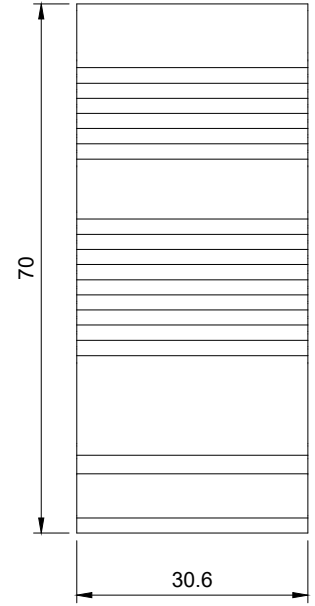
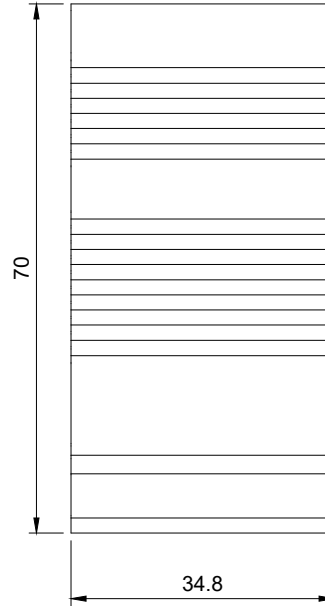
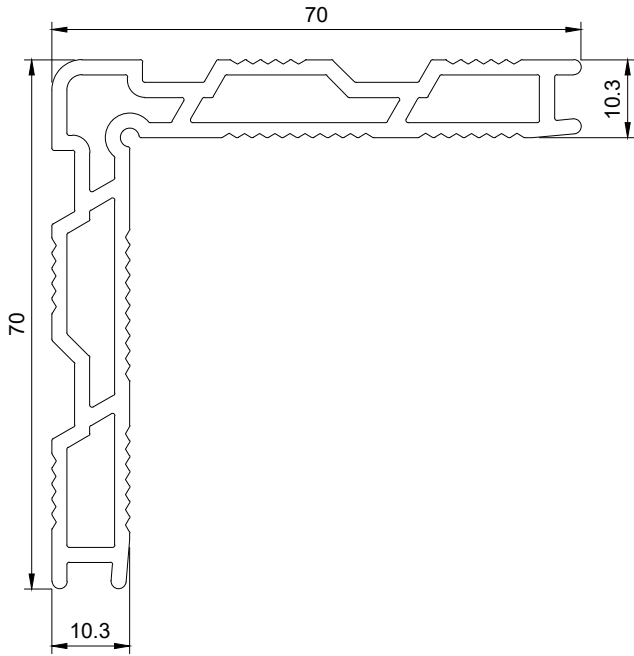

**APE 2070**  
Dimensions:  
82x20.7x30

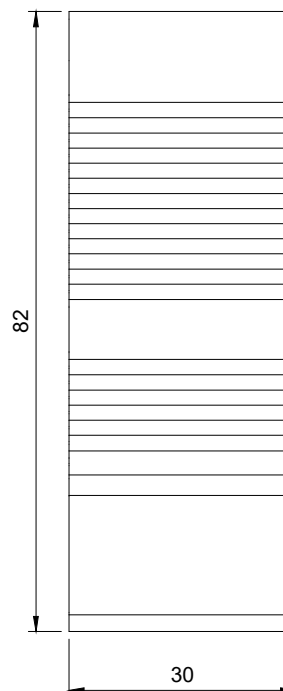
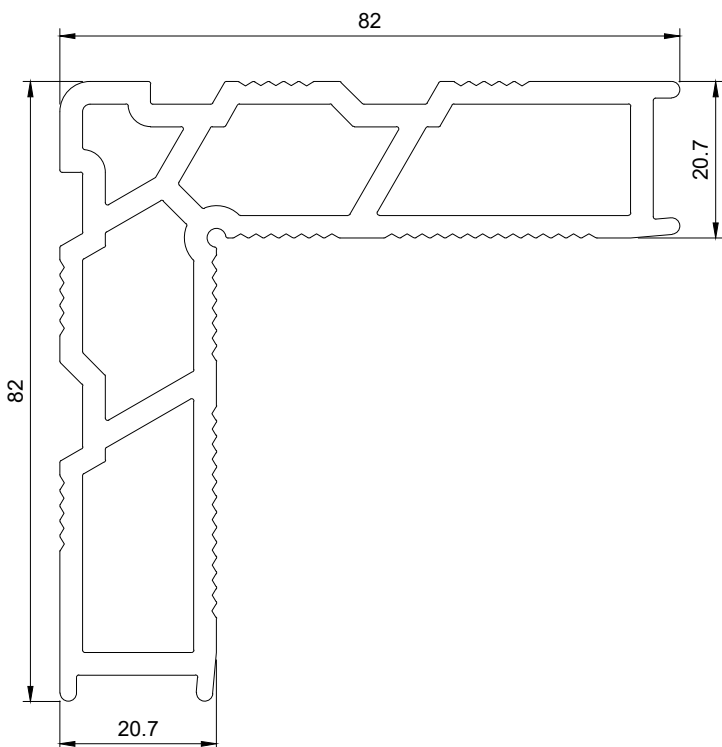

*press corners for crimping machine*

**APE 4180**  
**Dimensions:**  
104.5x41.8x30.2

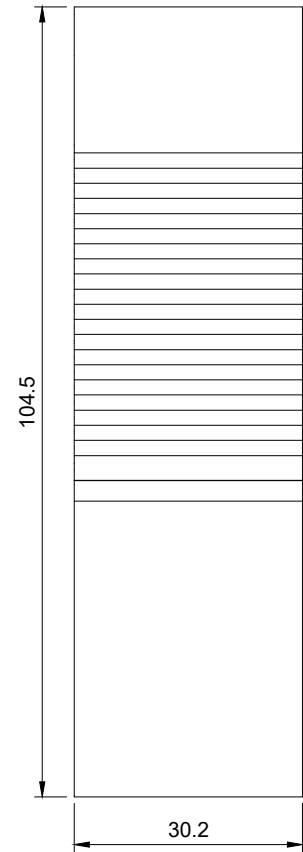
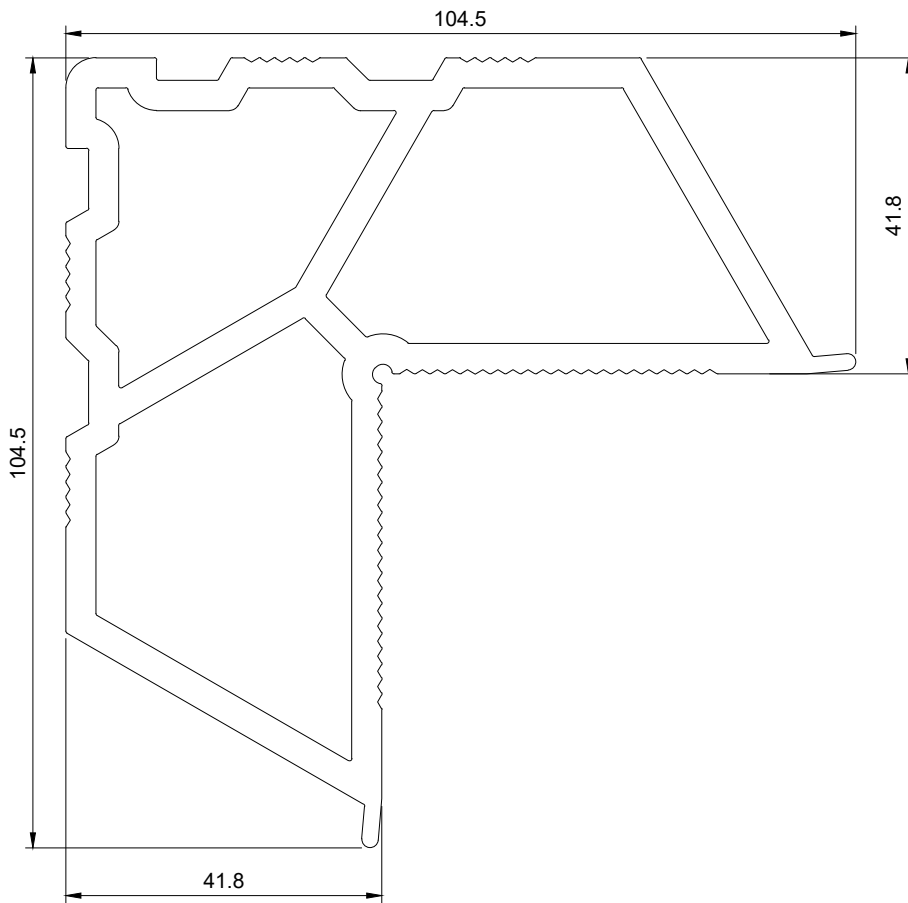

**corner connection 375 0004 frame  
with press corner**

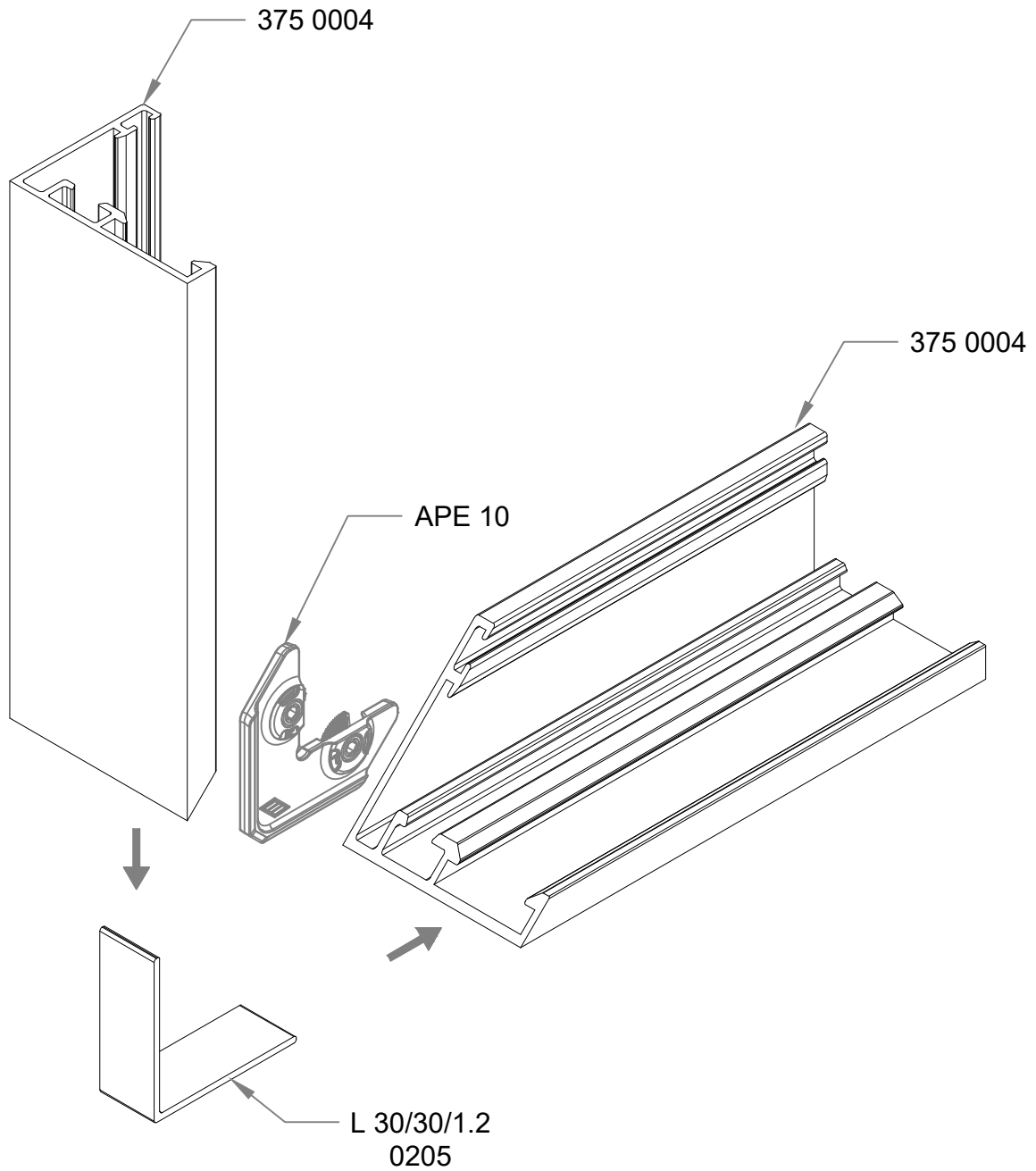

*corner connection 375 0005 frame  
with press corner*

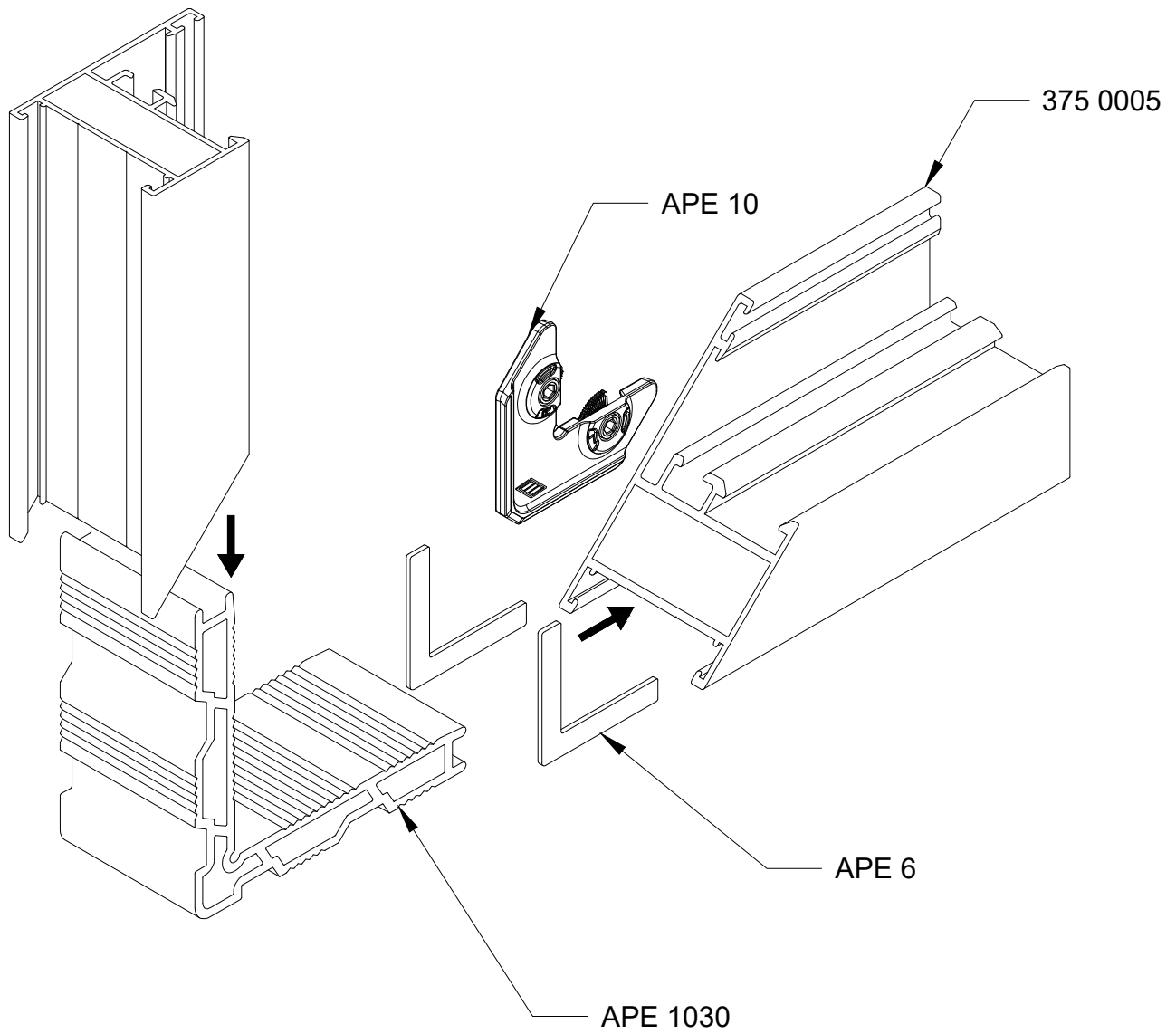



**corner connection 375 0005 frame  
with mechanical corner**

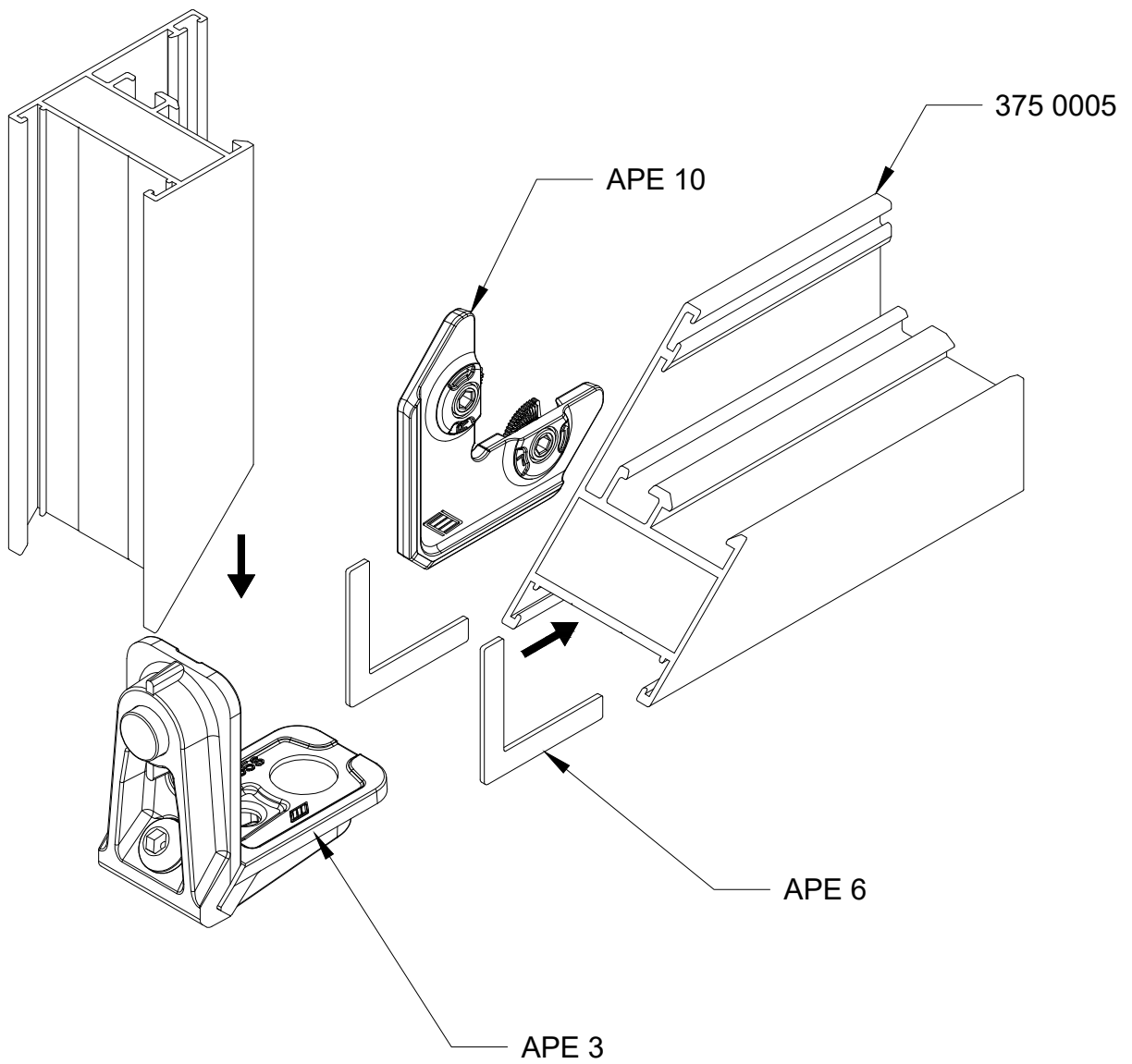

*corner connection 375 0020 frame  
with press corner*

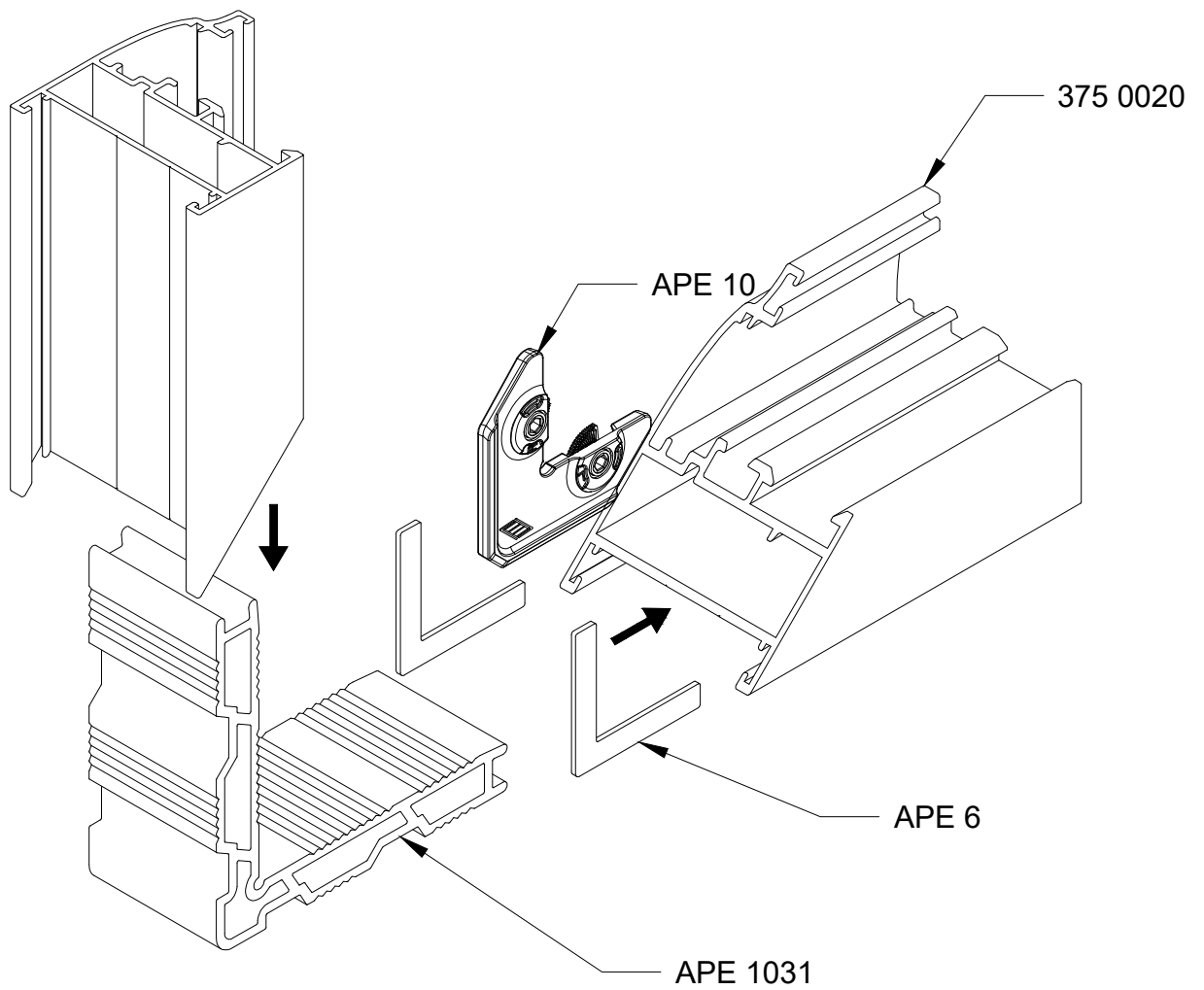

**corner connection 375 0020 frame  
with mechanical corner**

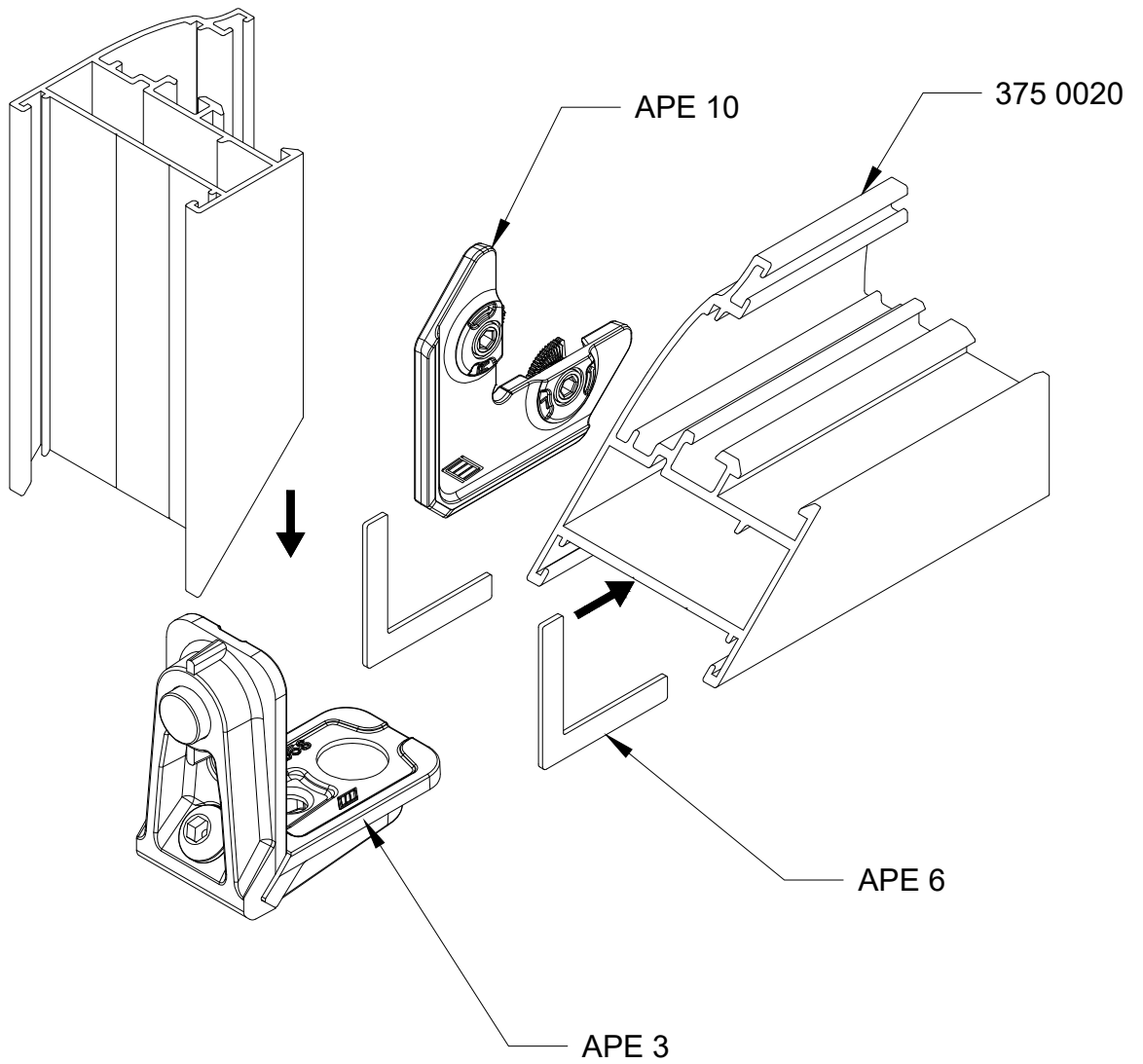

*corner connection 375 0010 frame  
with press corner*

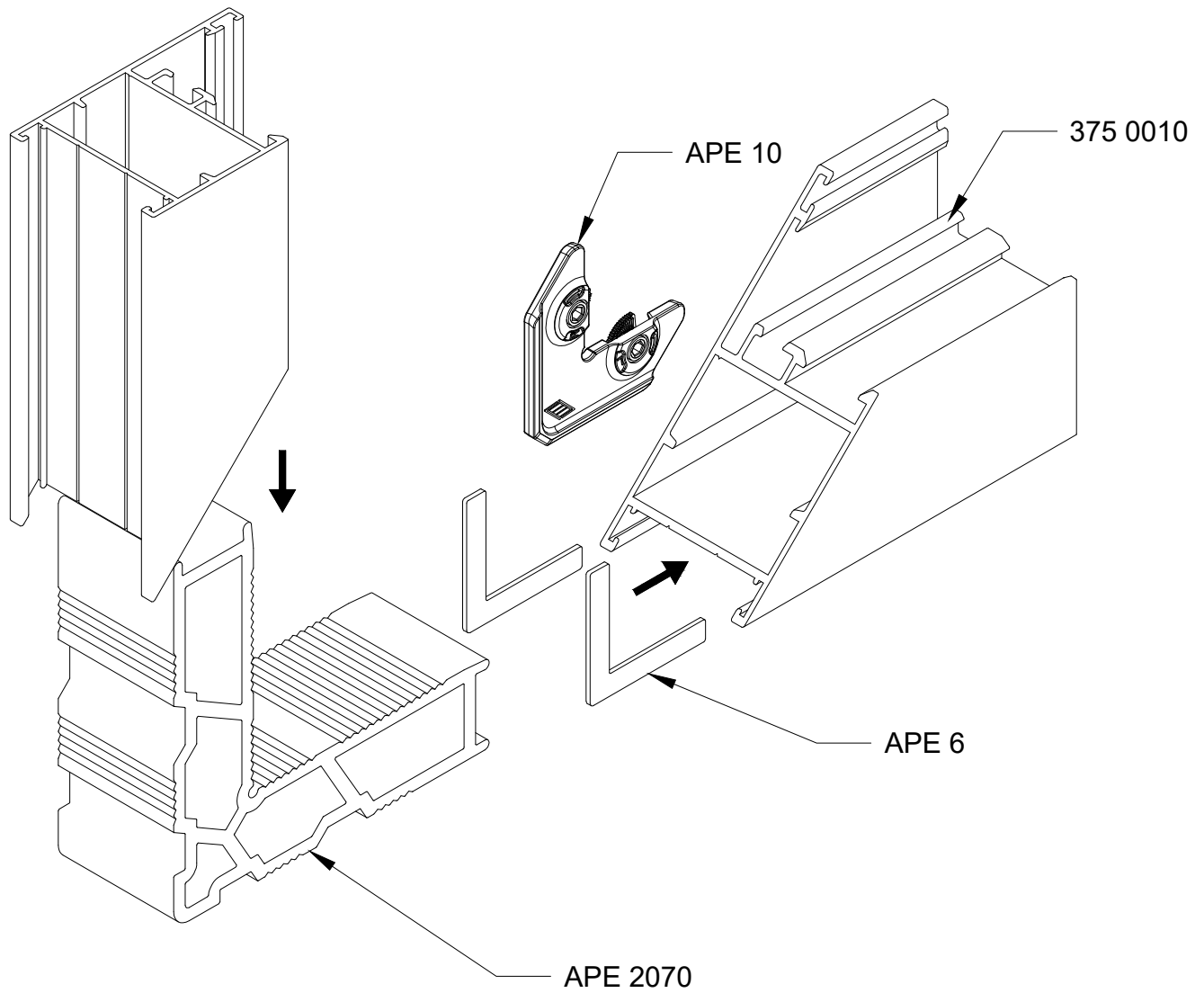

**corner connection 375 0010 frame  
with mechanical corner**

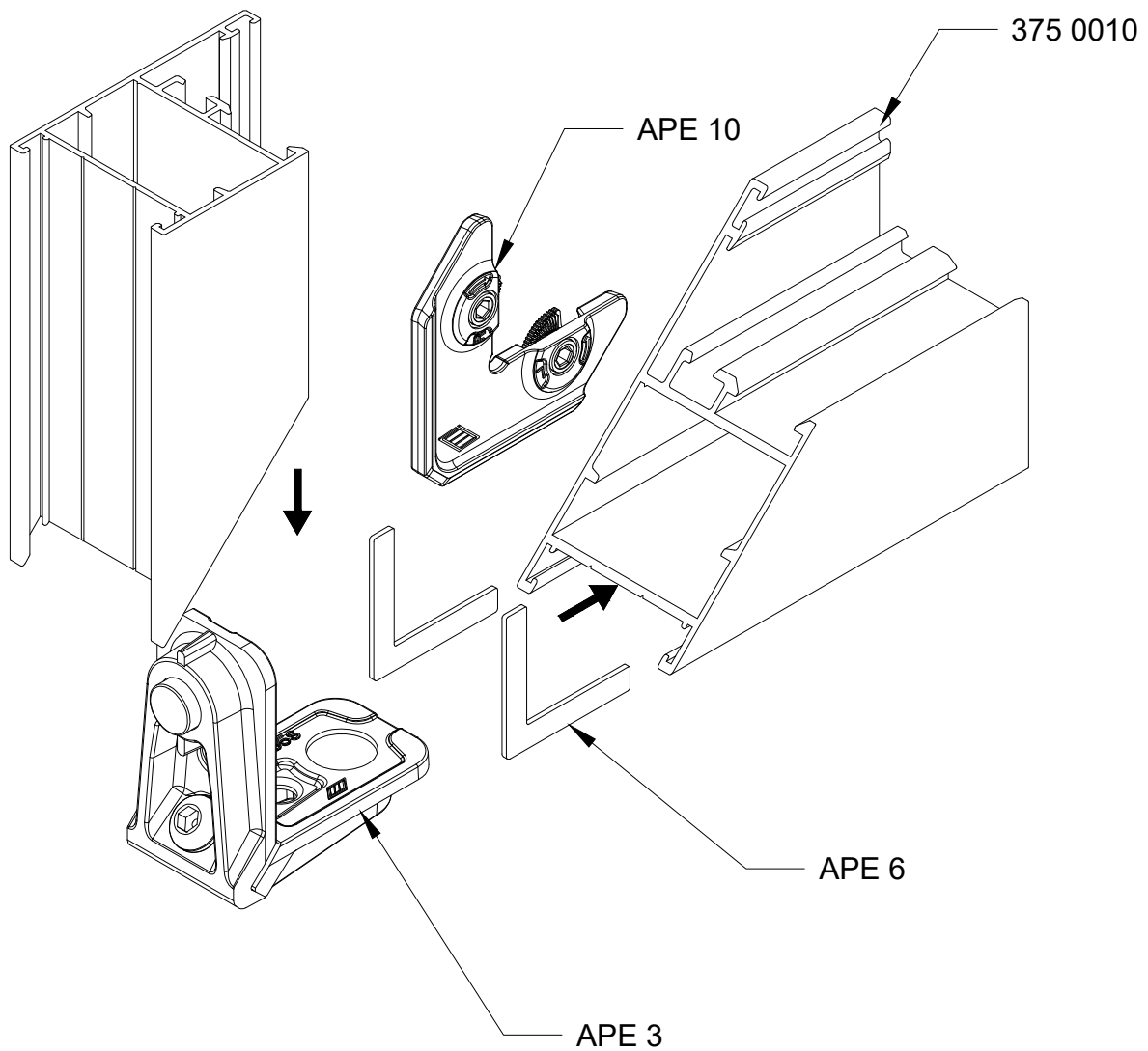

*corner connection 375 0105 sash with  
press corner*

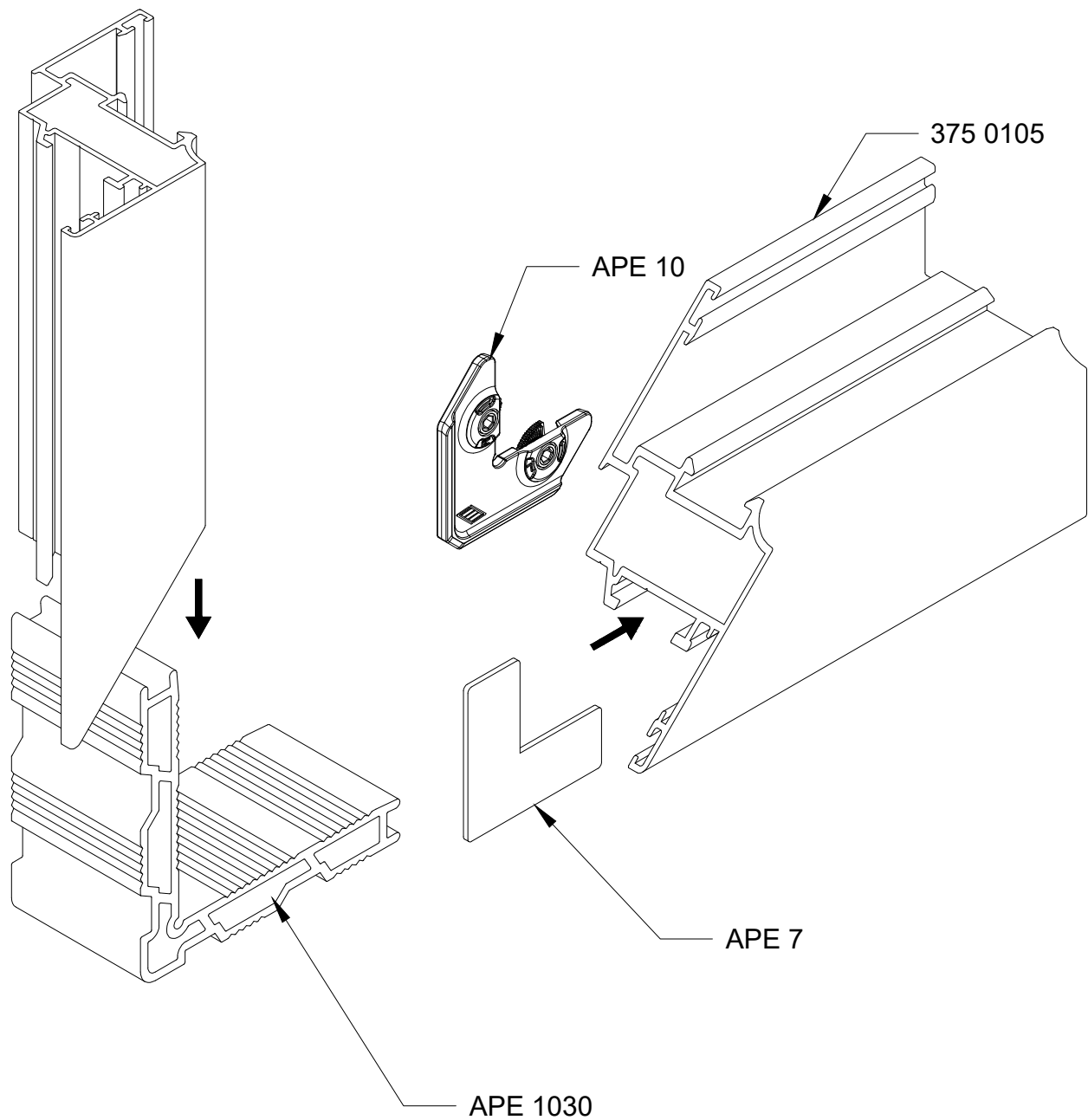

**corner connection 375 0105 sash with  
mechanical corner**

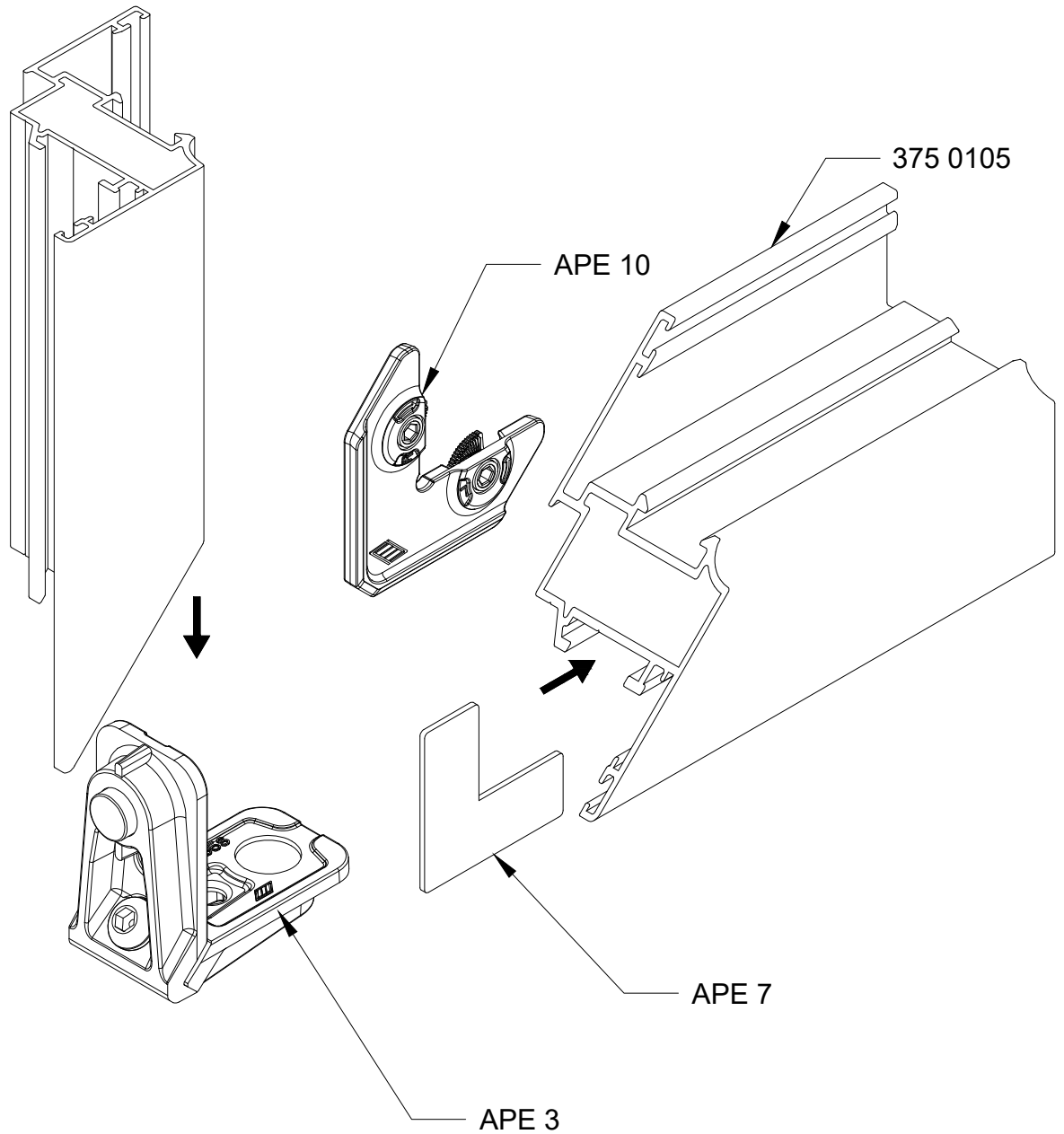

**corner connection 375 0115 sash with  
press corner**

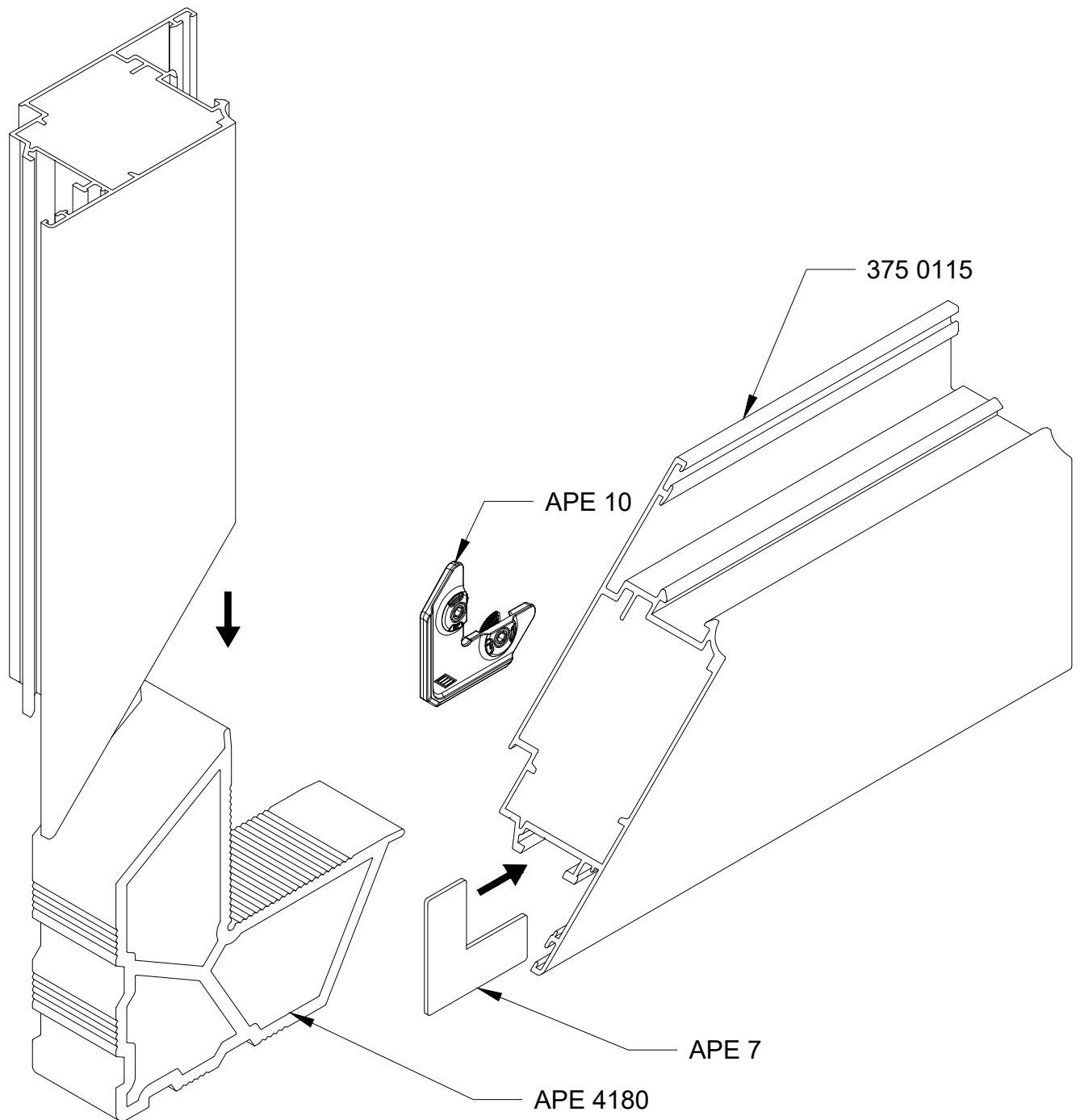



**corner connection 375 0115 sash with  
mechanical corner**

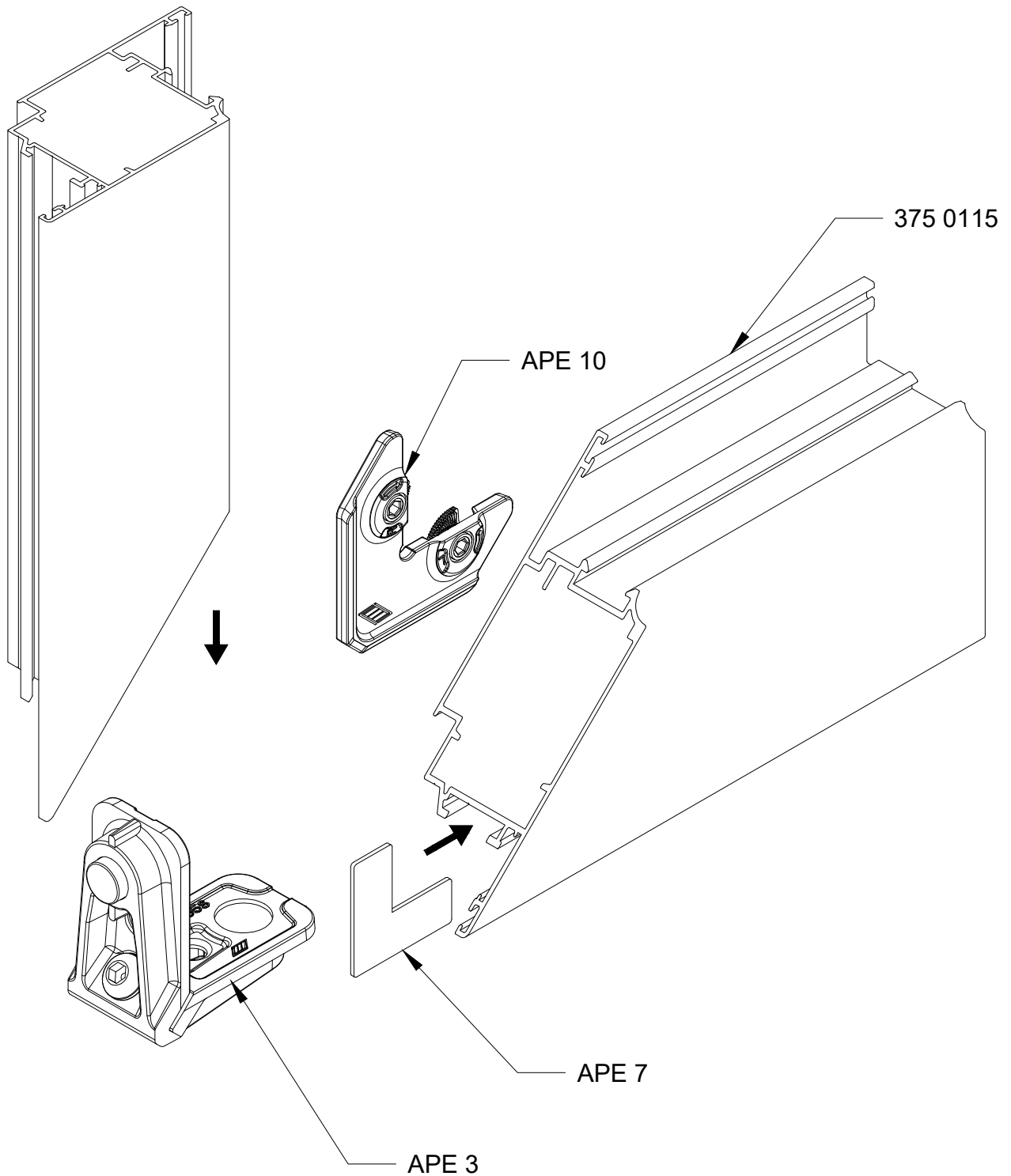

*handles for windows*

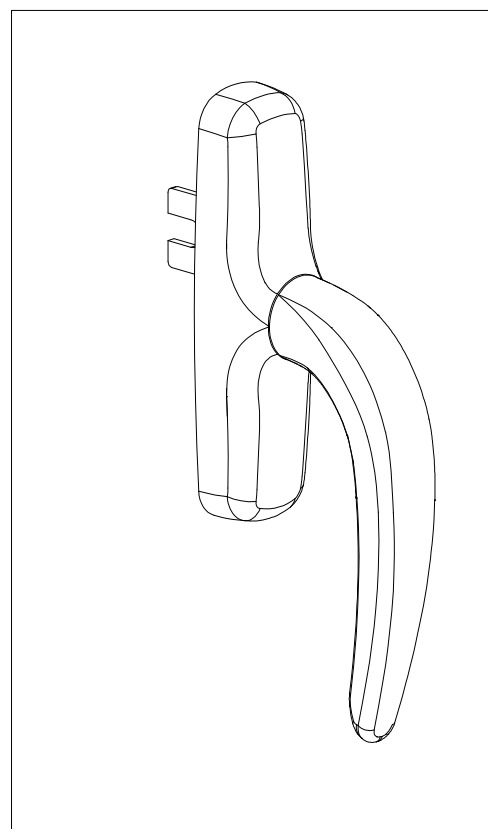
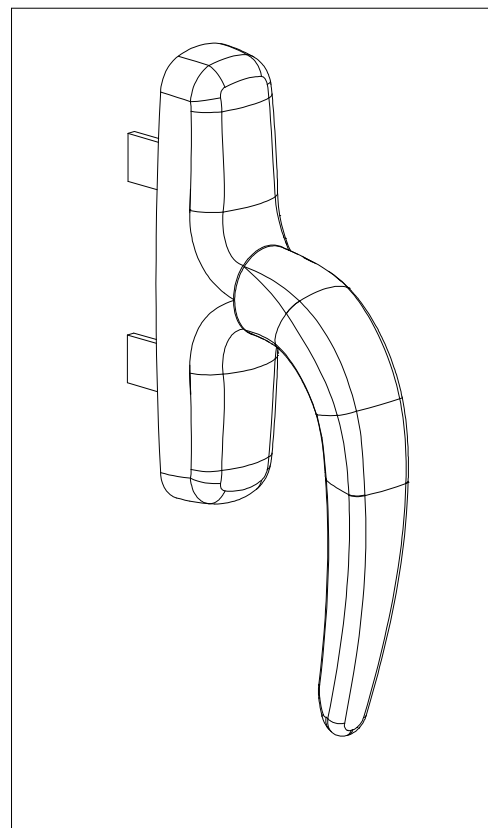
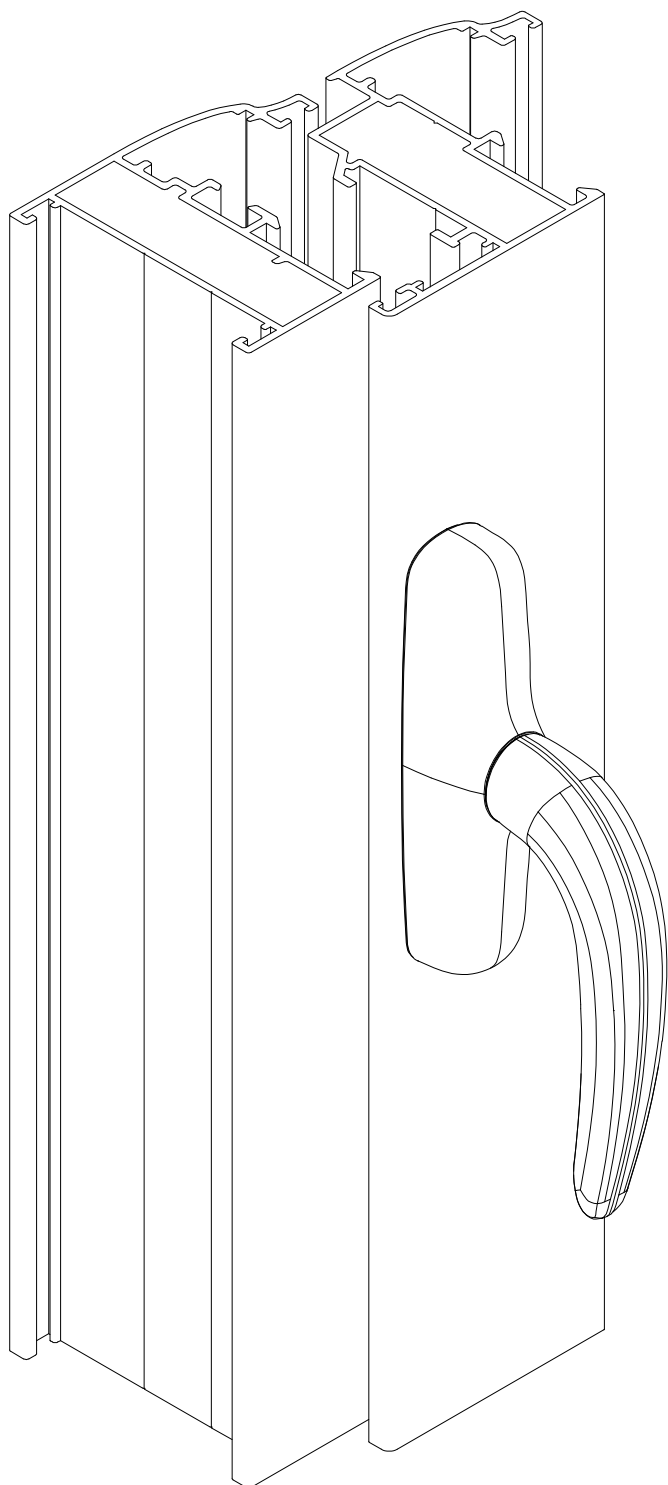

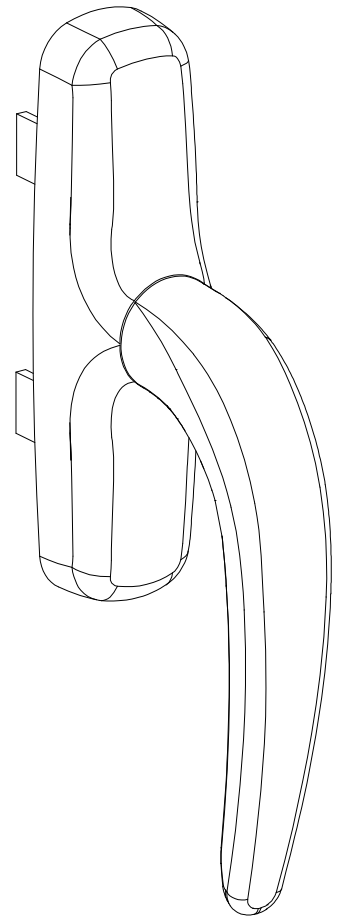
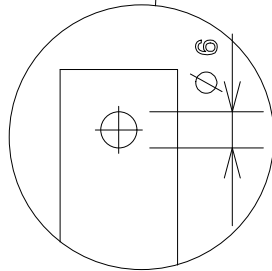
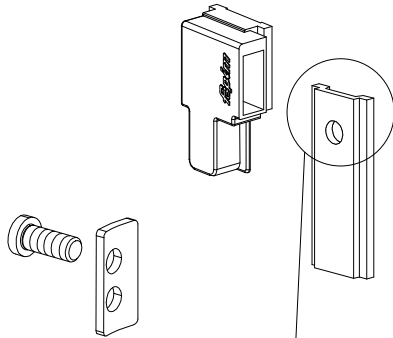
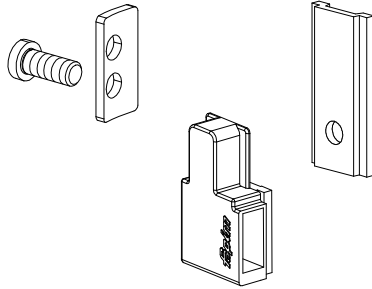
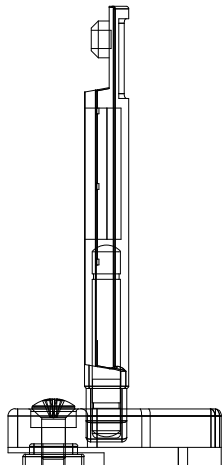
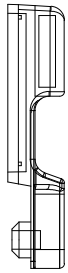
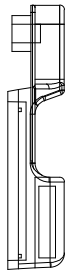
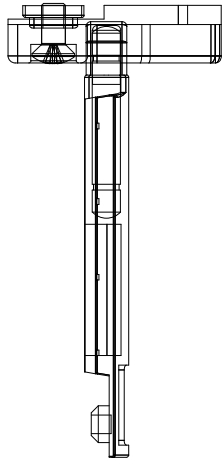

*milling & drilling dimensions for  
geared handle*

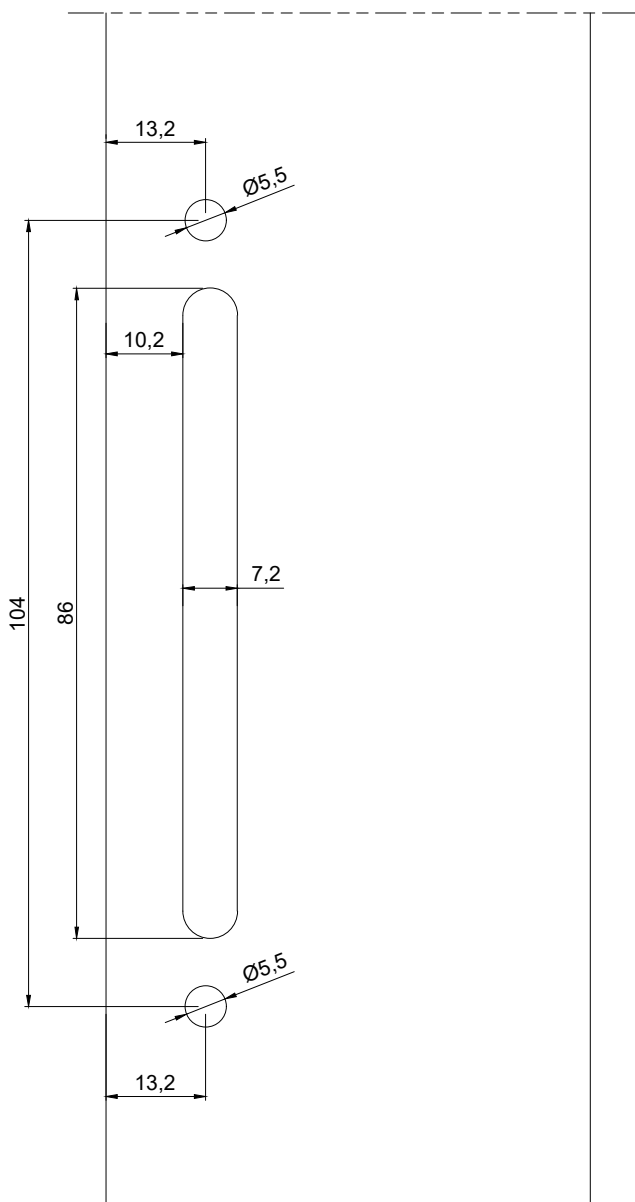
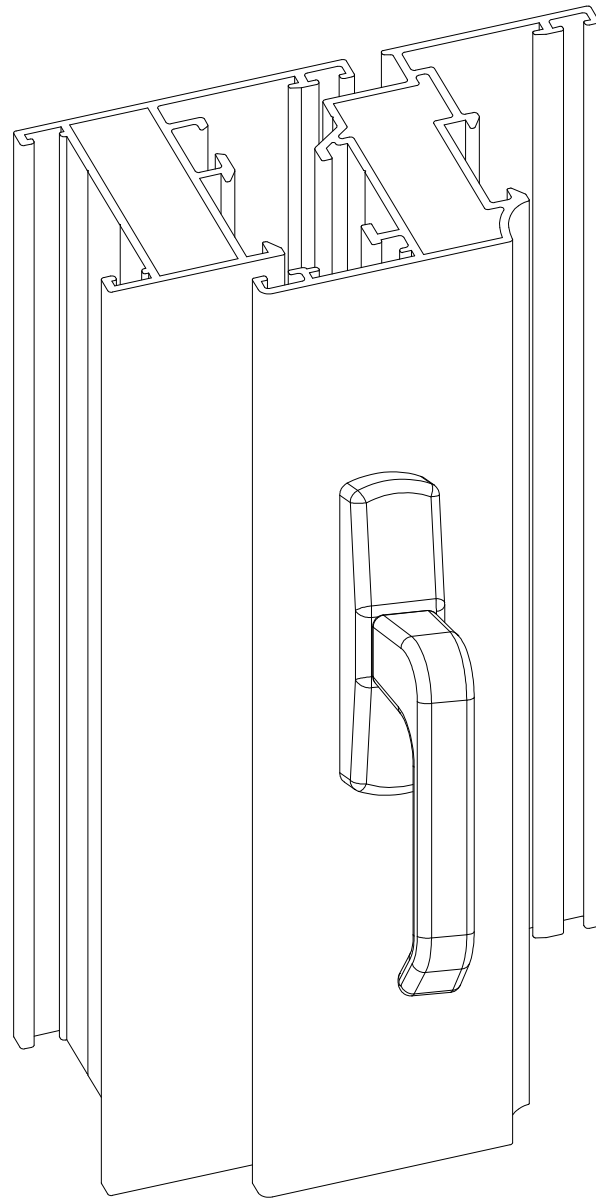
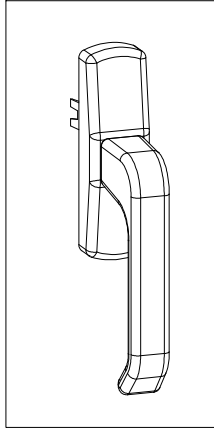

*perimetrical lock for windows  
tilt & turn sash*

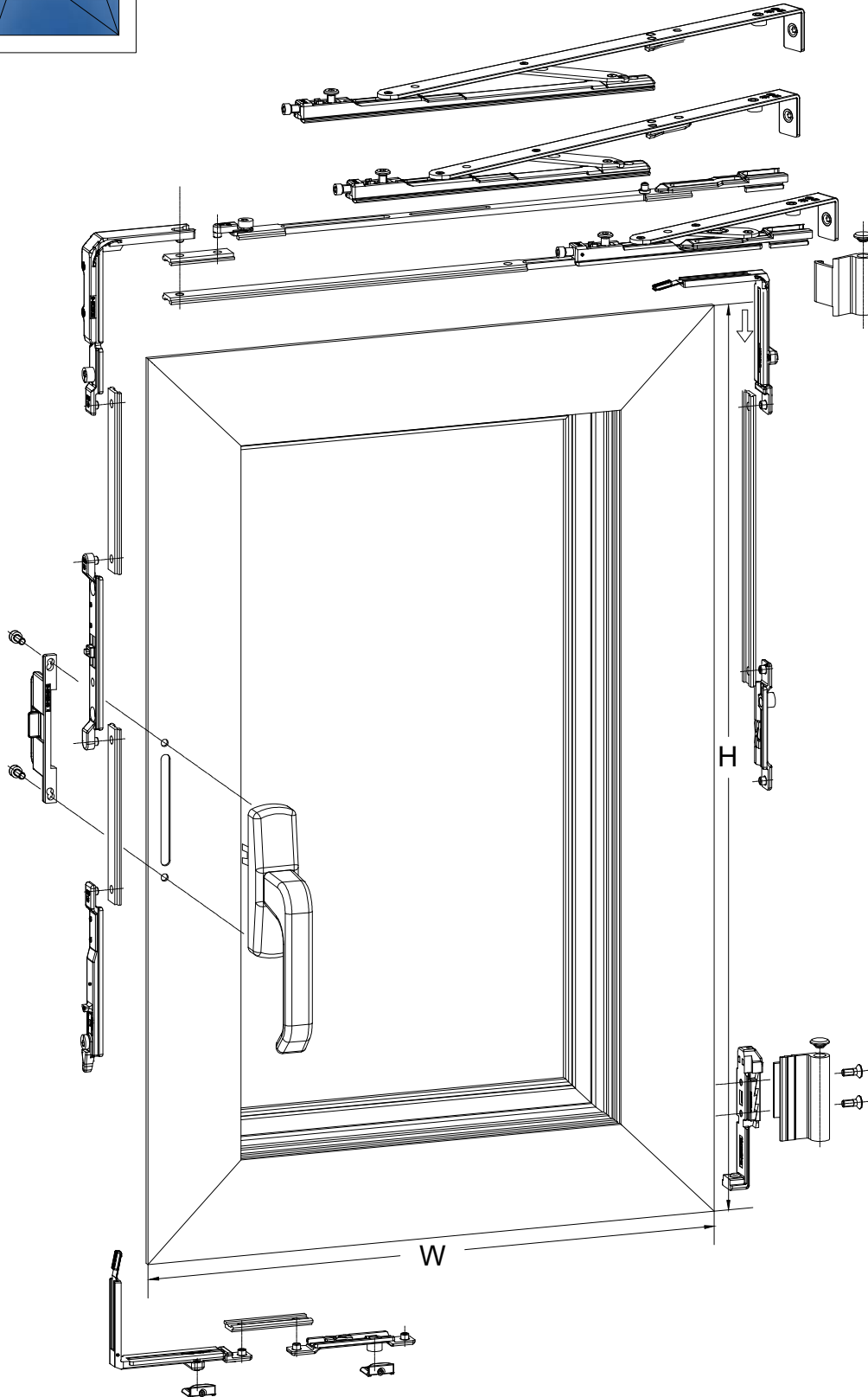
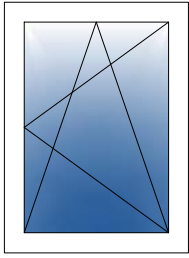

*Door lock*

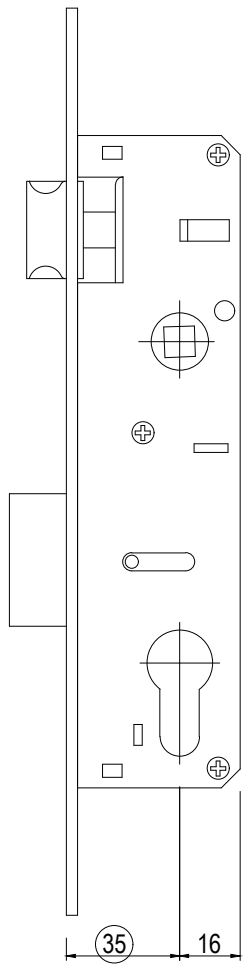
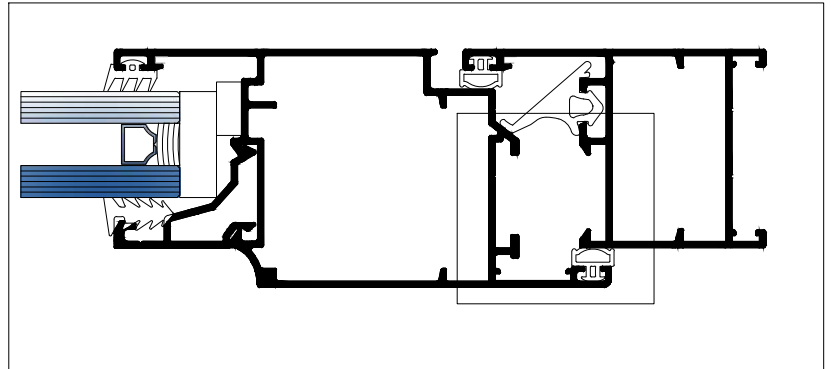

153 35

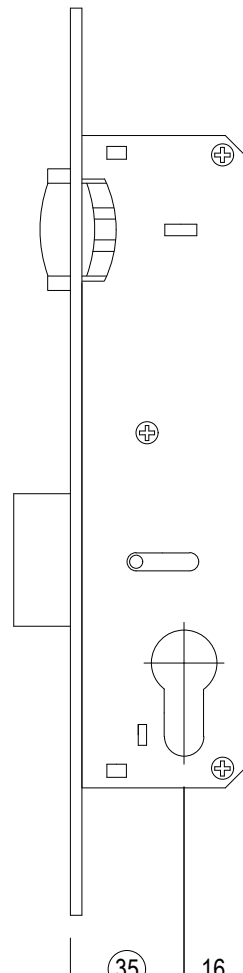
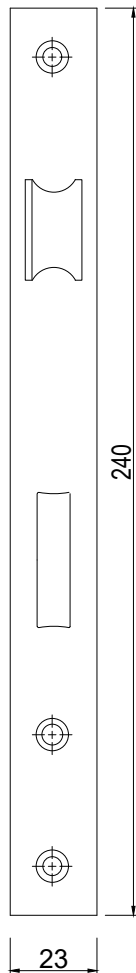

155 35

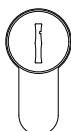
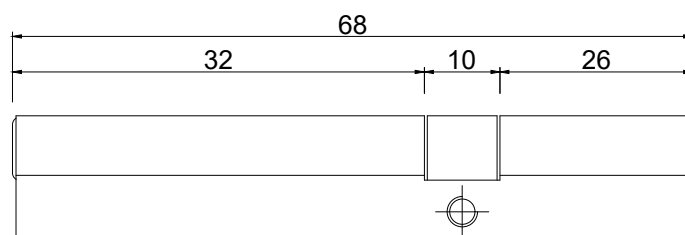
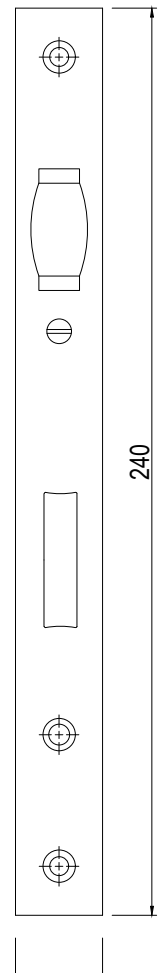

## Milling of the mullion

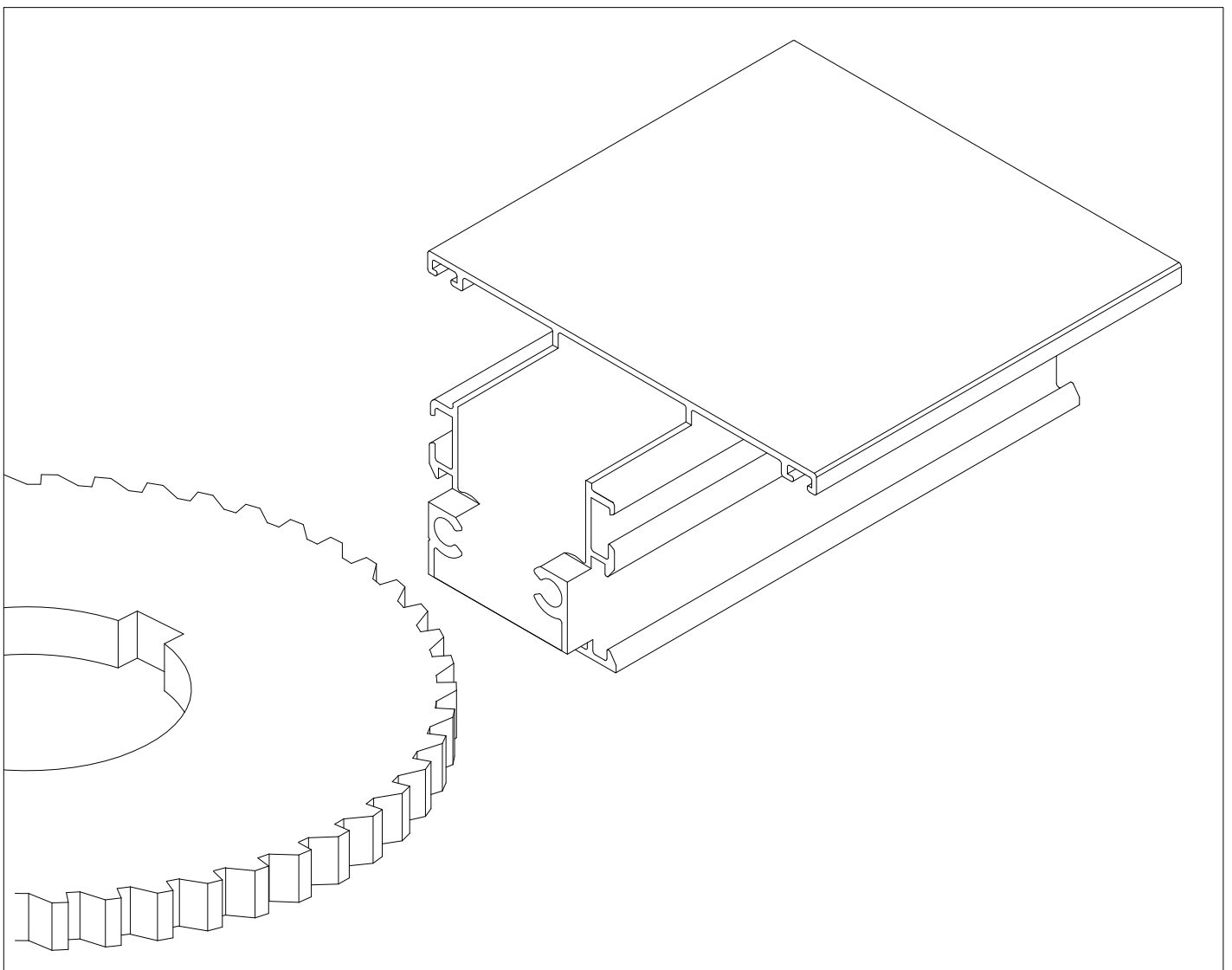
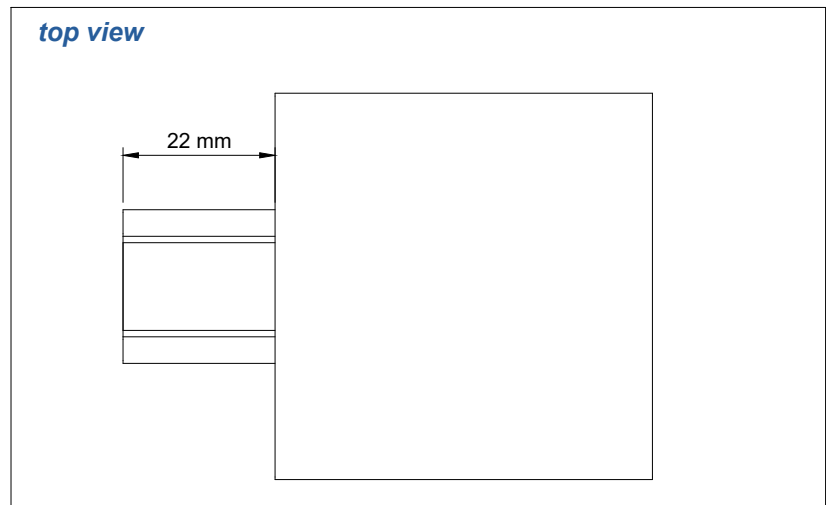

*cap for overhung 375 0305*

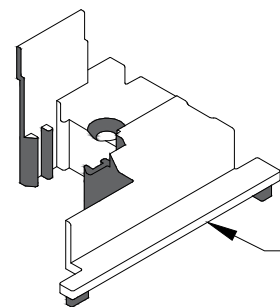
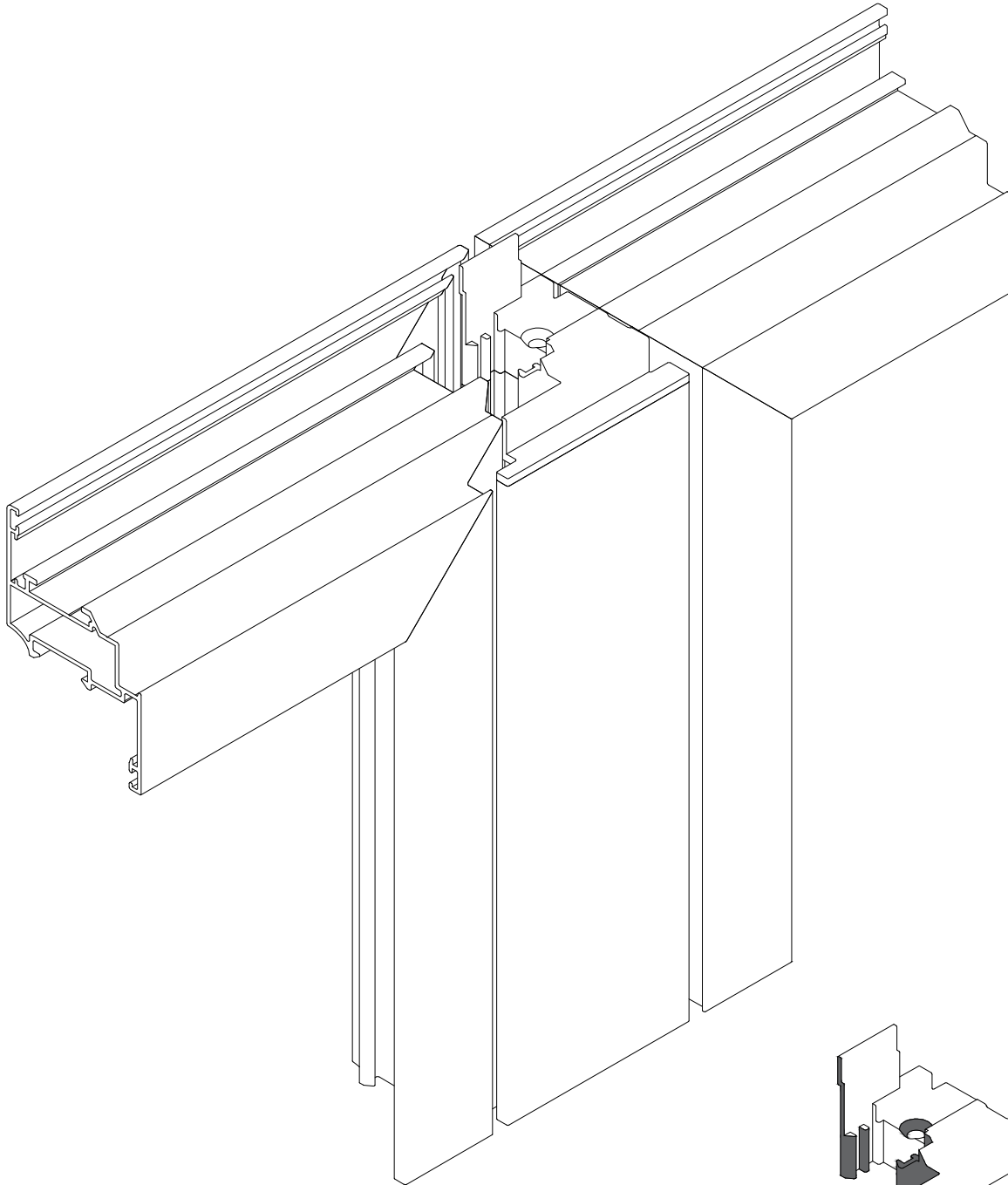

APE 211



*cap for overhung 375 0310*

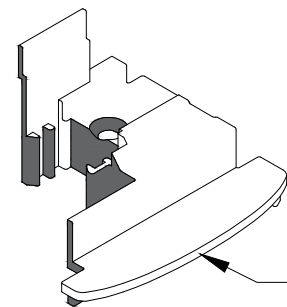
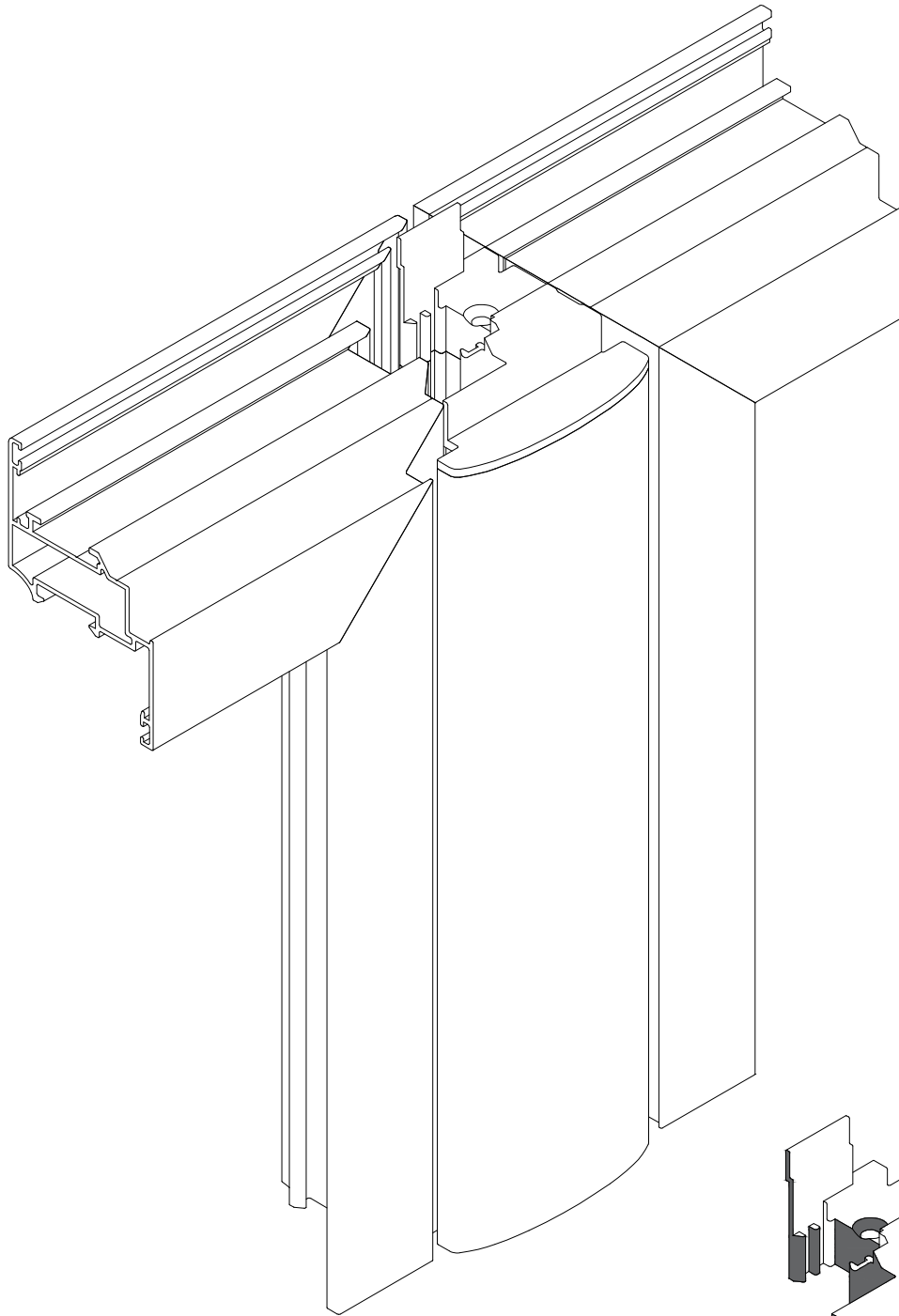

APE 200

*hinges for window*

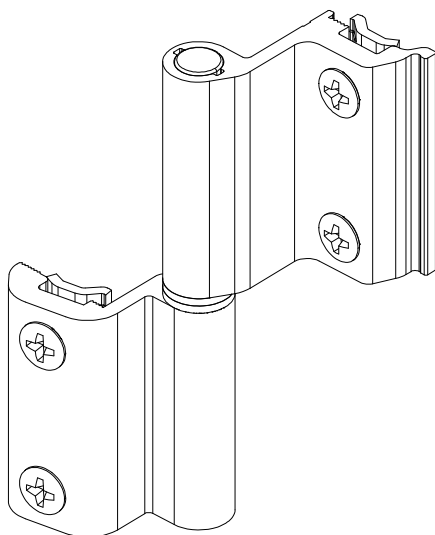
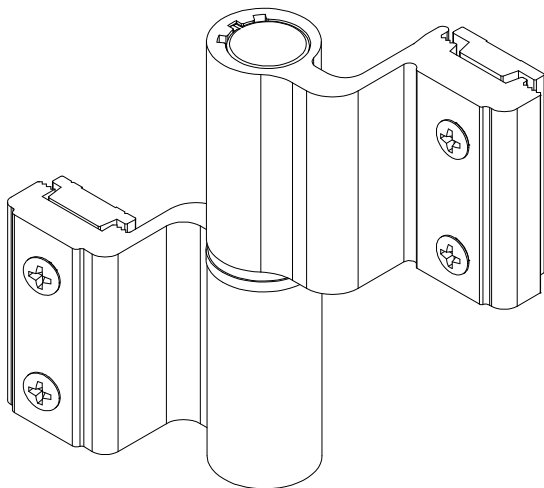
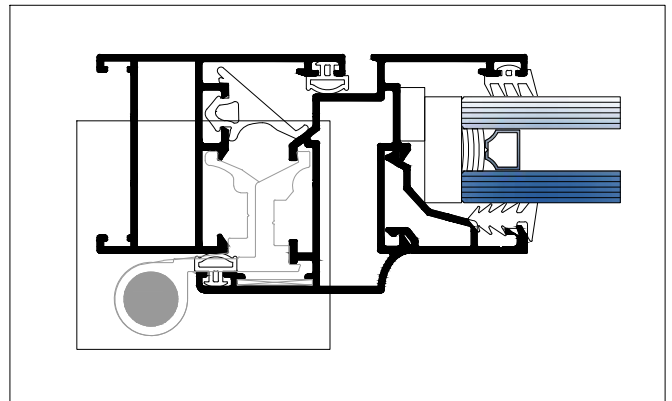

*hinges for window*

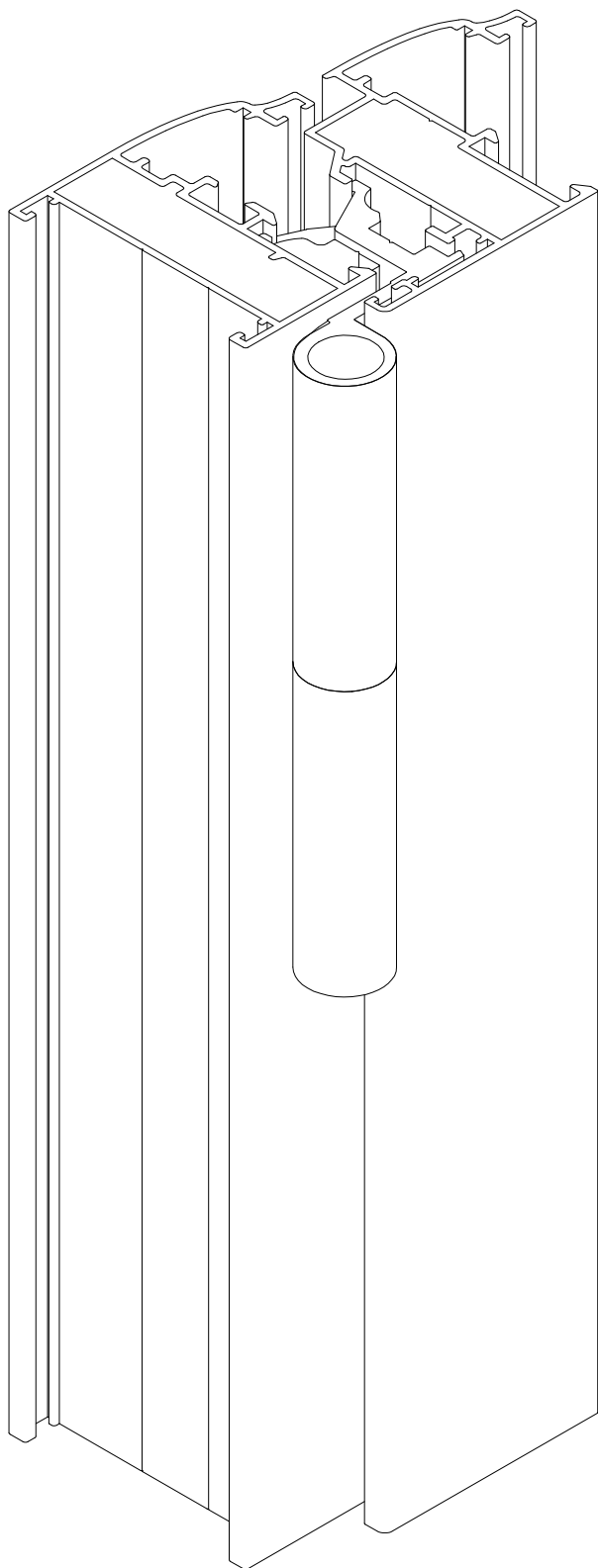

*latch for window*

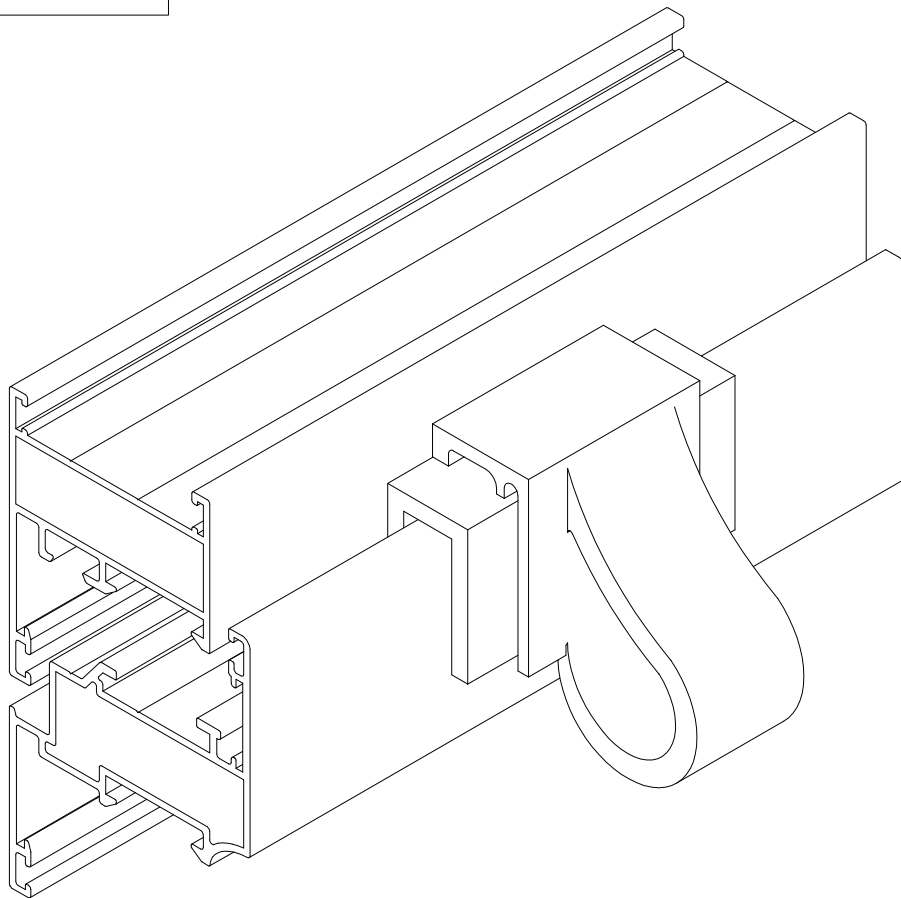
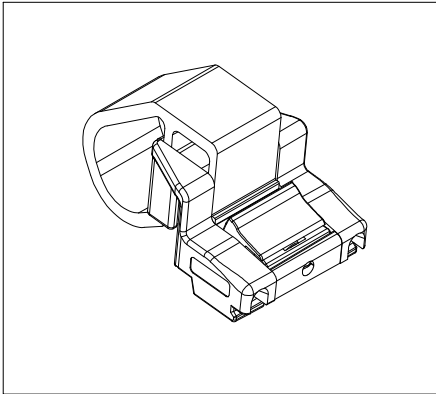

*hinges for two-side opening*

