



A ALTEST®

ALUMINIUM PROFILES SYSTEMS

LS 38



ALTEST®
Ltd.

ATTENTION !

For faultless operation, please read carefully this catalogue!

It was elaborated by ALTEST Company. Its copying, reproduction, and reprinting without our consent is not welcomed!

The profiles presented in the catalogue are patented and ALTEST Company has the exclusive rights. ALTEST Company reserves that right to modify the profiles and the presented sections at its own discretion. The system is equipped with full set of calculations made in accordance with the existing manufacturing requirements, presented in this catalogue.

In conclusion - use original ALTEST profiles in compliance with the peculiarities and the technical characteristics presented in this catalogue.



INTRODUCTION

The newest innovation in thermal sliding systems

The slide system **LS 38** represents the new evolution of Altest's advanced systems, for projects with wide plans and impressive characteristics.

The system complies perfectly with the modern trends of "transparent" architecture, combining high thermal insulation, safety and modern design. Its minimal design along with the state-of-the-art technology make it the ideal solution for projects enhancing natural lighting, satisfying even the most demanding requirements.

1. Water drainage system for heavy conditions.
2. Special water drainage valve, placed under the central interlocking profile, offering a high level of watertightness.
3. Cover caps with High Fin Weather seals for high weather and acoustic performance.
4. Central seals made with EPDM gaskets for high weather and acoustic performance.
5. Ideal for large openings with maximum window height of 2500mm and maximum weight of 150kg with special accessories.

Technical Details

The **LS 38** system can be delivered and installed by our team of installers located in every major city in Greece.

The lock used in the **LS 38** system is placed in the glazing. At the same time, it serves as a handle, giving ease of usage, design and ideal aesthetics as it does not obstruct the view of outside space. For its construction stainless steel is used.

Techical Characteristics	
Frame height	46mm
Frame width	93mm
Sash height	89mm
Sash width	38mm
Interlocking profile width	96mm
Sash weight	Up to 120Kg
Glazing	Up to 24mm
Insulation	Polyamides, PVC

Performances

Thermal Isulation
-EN ISO 10077-2

$$U_w = 2,0 \text{ W/m}^2\text{K}$$



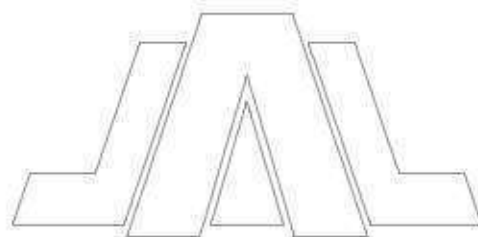







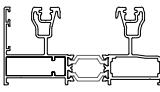

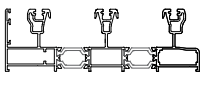
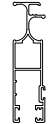
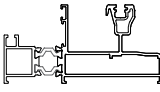
* For window dimensions 5,00 X 2,50 m and $U_g = 1,0 \text{ W/m}^2\text{K}$

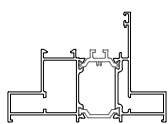
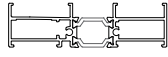

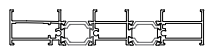
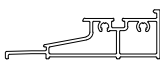
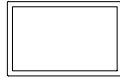
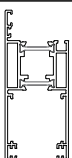
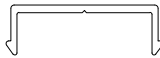
PROFILES OVERVIEW

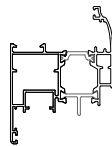

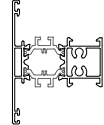
PROFILES OVERVIEW









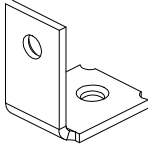
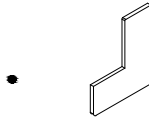

38 0001	lx cm ⁴	ly cm ⁴		38 0013	lx cm ⁴	ly cm ⁴	
	14,30	55,96			4,59	4,58	
DOUBLE RAIL FRAME PROFILE	Weight			HOOK PROFILE	Weight		
	1840 gr/m				523 gr/m		
38 0002	lx cm ⁴	ly cm ⁴		300 0128	lx cm ⁴	ly cm ⁴	
	20,59	184,02			11,79	1,07	
TRIPLE RAIL FRAME PROFILE	Weight			MOSQUITO PROFILE	Weight		
	2750 gr/m				811 gr/m		
38 0003	lx cm ⁴	ly cm ⁴		07 0012	lx cm ⁴	ly cm ⁴	
	11,54	49,14			1,52	0,61	
SINGLE RAIL (WITH FIXED) FRAME PROFILE	Weight			MOSQUITO RAIL PROFILE	Weight		
	1550 gr/m				311 gr/m		
38 0004	lx cm ⁴	ly cm ⁴		38 0014	lx cm ⁴	ly cm ⁴	
	1,24	30,22			2,21	39,37	
FRAME CONNECTOR PROFILE	Weight			DRAINAGE PROFILE FOR DOUBLE RAIL FRAME	Weight		
	1645 gr/m				1290 gr/m		
38 0005	lx cm ⁴	ly cm ⁴		38 0015	lx cm ⁴	ly cm ⁴	
	0,87	5,87			3,39	128,81	
THRESHOLD PROFILE	Weight			DRAINAGE PROFILE FOR DOUBLE RAIL FRAME	Weight		
	660 gr/m				1990 gr/m		
38 0006	lx cm ⁴	ly cm ⁴		38 0016	lx cm ⁴	ly cm ⁴	
	3,49	38,10			1,24	2,48	
BASE THRESHOLD PROFILE	Weight			STANDARD PROFILE 22X34X1.5mm	Weight		
	1260 gr/m				429 gr/m		
38 0007	lx cm ⁴	ly cm ⁴		38 0017	lx cm ⁴	ly cm ⁴	
	10,14	41,81			0,01	0,02	
SASH PROFILE	Weight			COUPLING PROFILE	Weight		
	1390 gr/m				97 gr/m		
38 0010	lx cm ⁴	ly cm ⁴		530 0326	lx cm ⁴	ly cm ⁴	
	1,48	0,91			13,36	21,25	
MEETING STILE PROFILE	Weight			SASH PROFILE	Weight		
	453 gr/m				1364 gr/m		
38 0011	lx cm ⁴	ly cm ⁴		530 0205	lx cm ⁴	ly cm ⁴	
	14,69	28,69			9,27	15,76	
GLAZING BEAD	Weight			MULLION PROFILE	Weight		
	120 gr/m				1276 gr/m		
38 0012	lx cm ⁴	ly cm ⁴		375 0530	lx cm ⁴	ly cm ⁴	
	0,79	4,08			0,73	0,5	
COVER PROFILE	Weight			GLAZING BEAD	Weight		
	450 gr/m				260 gr/m		

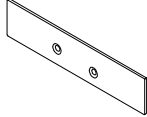
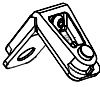
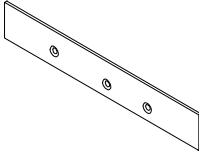
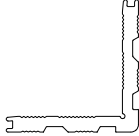
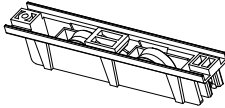
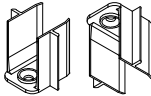
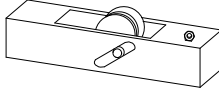
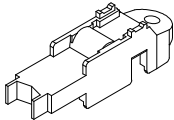
ACCESSORIES OVERVIEW

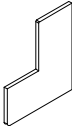
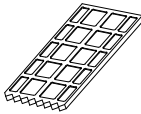
SLIDE 38

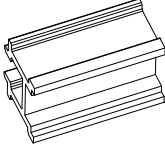
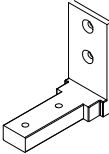

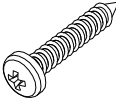
ACLS 3801		TZ 5,5	
PVC PROFILE		BRUSH 5,5mm	
US 11.5100		TZ 7	
EPDM GASKET		BRUSH 7mm	
ULS 3806		LS 0701	
EPDM GASKET		STAINLESS STEEL (INOX) RAIL GUIDE	
ULS 3807		ACLS 3802	
EPDM GASKET		CENTRAL WEATHERING BLOCK	
US 68		ACLS 3804	
EPDM GASKET		HOOK CAP	
U 00.0;1;1.5; 2;2.5;3;4;5		ACLS 3805	
EPDM GASKET		CAL CORNER 11 x 19,5	
US 0704		APE2610	
EPDM GASKET		PRESS CORNER 20,7X21,5mm	
US 60		LS070400	
EPDM GASKET		PRESS CORNER 10,5X26,2mm	
APE 900		APE 4	
EPDM GASKET		MECHANICAL CORNER (0365S)	
UK 7		APE 10	
EPDM GASKET		ALIGNMENT CORNER (APE-10)	





BA1001		APE 7	
CONNECTOR FOR FIXED FRAME		ALIGNMENT CORNER 14.6x1.3	
APE 157			
CAL CORNER 14,6x14,7		END CAP for 38 0014	
APE 8			
MECHANICAL CORNER 0423 (10.6x19)		END CAP for 38 0015	
APE-0550		ACLS 3807	
PRESS CORNER 8,6x5,8		ROLLER	
ACLS 3808		A0103	
CAP FOR MEETING STILE		WHEEL FOR MOSQUITO PROFILE	
ACLS 3809			
SASH ABSORBER		HANDLE	
APE 71		AP 325	
ALIGNMENT CORNER 28x1.6		GLAZING SPACER 5mm	
APE 6		GUL14-H-11140-38-0-6	
ALIGNMENT CORNER 5x1		PACKER FOR INLINE GEAR	
ACLS3806			
CONNECTOR FOR NARROW SASH		ST SCREW 4.2X22mm	
ST SCREW 4.2X13mm			
ST SCREW 4.2X19mm		ST SCREW 4.2X25mm	





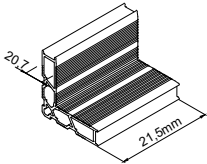
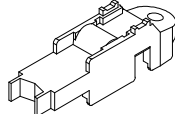
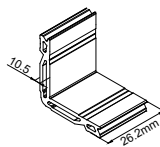
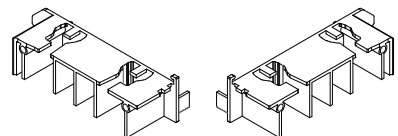

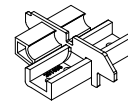
ACCESSORIES OVERVIEW

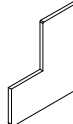
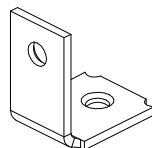
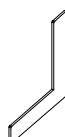
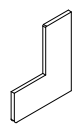
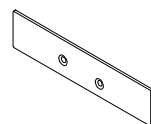
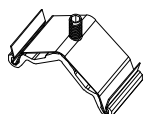
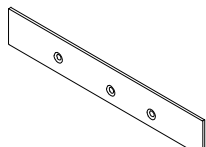
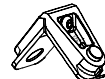
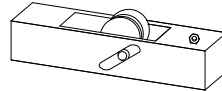
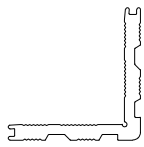
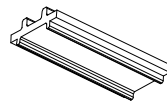
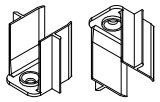
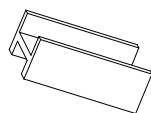
LIFT & SLIDE 38

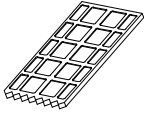

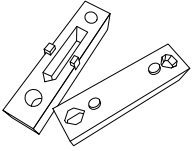
ACLS 3801		UR 3809	
PVC PROFILE		EPDM GASKET	
US 11.5100		ULS 3805	
EPDM GASKET		EPDM GASKET	
ULS 3806		UK 7	
EPDM GASKET		EPDM GASKET	
ULS 3807		TZ 5,5	
EPDM GASKET		BRUSH 5,5mm	
US 68		TZ 7	
EPDM GASKET		BRUSH 7mm	
U 00.0;1;1.5; 2;2.5;3;4;5		LS 0701	
EPDM GASKET		STAINLESS STEEL (INOX) RAIL GUIDE	
US 0704		KLS072	
EPDM GASKET		FRAME AND SASH GASKET SET	-1piece- central gasket down
US 60			-1piece- central gasket up
EPDM GASKET			-4 pieces- ST screw 4.2x13mm
APE 900		ACLS 3803	
EPDM GASKET		HOOK CAP (L&S)	
US 0702		ACLS 3805	
EPDM GASKET		CAL CORNER 11 x 19,5	

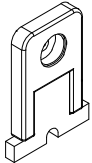
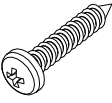
APE2610		ACLS 3809	
PRESS CORNER 20,7X21,5mm		SASH ABSORBER	
LS070400		ACLS 3810	
PRESS CORNER 10,5X26,2mm		90 DEGREES CORNER CONNECTOR	
APE 4		ACLS 3811	
MECHANICAL CORNER (0365S)		CAP FOR CONNECTING PROFILES 38 0005 & 38 0006	
APE 10		APE 71	
ALIGNMENT CORNER (APE-10)		ALIGNMENT CORNER 28x1.6	
BA1001		APE 6	
CONNECTOR FOR FIXED FRAME		ALIGNMENT CORNER 5x1	
APE 7			
ALIGNMENT CORNER 14.6x1.3		END CAP for 38 0014	
APE 157			
CAL CORNER 14,6x14,7		END CAP for 38 0015	
APE 8		A0103	
MECHANICAL CORNER 0423 (10.6x19)		WHEEL FOR MOSQUITO PROFILE	
APE-0550		GUL 149 47296 38 06	
PRESS CORNER 8,6x5,8		SPACER FOR GEAR GU-937	
ACLS 3808		GUL 146 39690 38 00	
CAP FOR MEETING STILE		PLASTIC TEMPLATE FOR RUNNER GU-937	

AP 325		St 4.2x13mm	
GLAZING SPACER 5mm		ST SCREW 4.2X13mm	
ACLS 3813		St 4.2x19mm	
PLASTIC GUIDE FOR RUNNER GU-937 SET (38 007)		ST SCREW 4.2X19mm	
ACLS 3812		St 4.2x22mm	
HOOK CAP (38 0006)		ST SCREW 4.2X22mm	
		St 4.2x25mm	
		ST SCREW 4.2X25mm	

PROFILES
(scale 1:1)



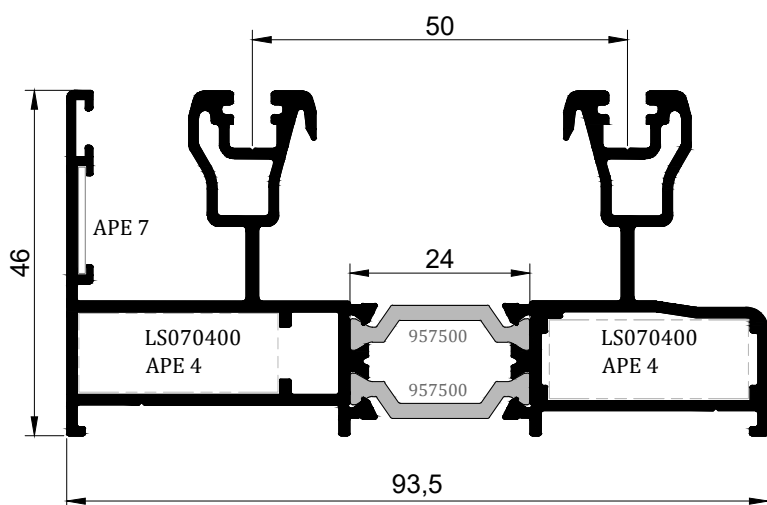

38 0001	Weight	$I_x \text{ cm}^4$	$I_y \text{ cm}^4$			
	1,84 kg/mt	14,30	55,96			
JOINTS						
	LS070400	APE 4	APE 7			
GASKETS & OTHER S38						
	TZ 5,5	LS 0701	ACLS 3801	ACLS 3802	US 0704	
	GASKETS & OTHER LS38					
		TZ 5,5	LS 0701	ACLS 3801	KLS 072	US 0704

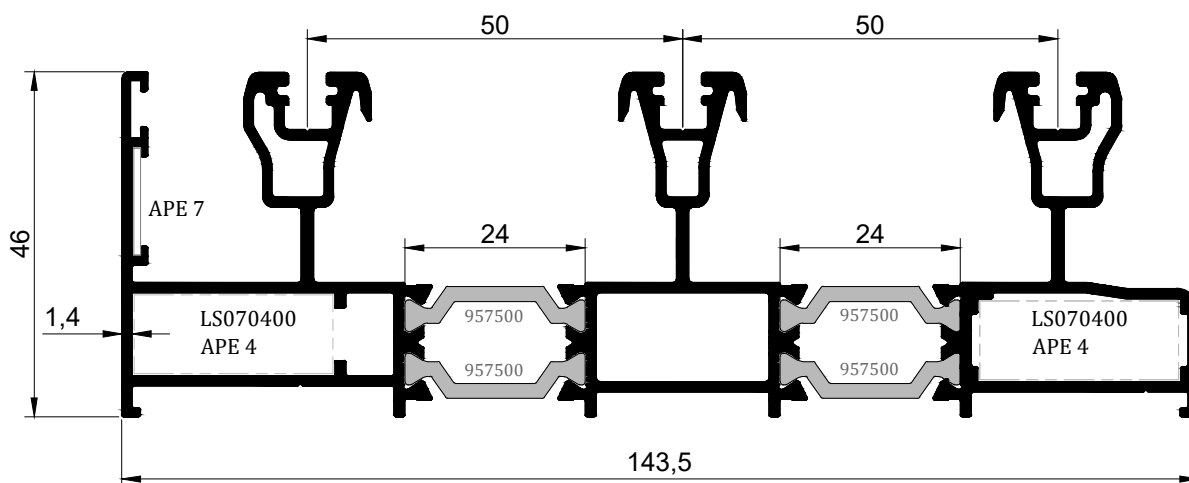

38 0002	Weight	$I_x \text{ cm}^4$	$I_y \text{ cm}^4$			
	2,75 kg/mt	20,59	184,02			
JOINTS						
	LS070400	APE 4	APE 7			
GASKETS & OTHER S38						
	TZ 5,5	LS 0701	ACLS 3801	ACLS 3802	US 0704	
	GASKETS & OTHER LS38					
		TZ 5,5	LS 0701	ACLS 3801	KLS 072	US 0704

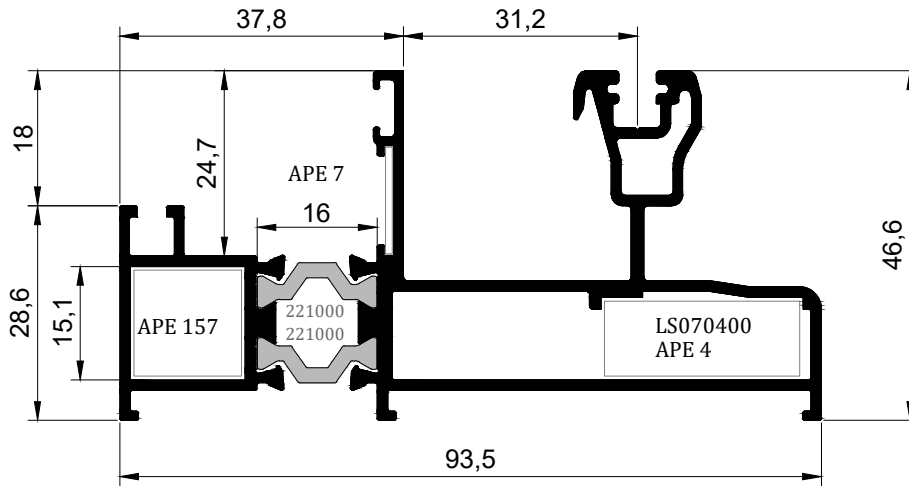

38 0003	Weight	$I_x \text{ cm}^4$	$I_y \text{ cm}^4$
	1,55 kg/mt	11,54	49,14
JOINTS	APE 157	LS070400	APE 4
GASKETS & OTHER S38 & LS38	LS 0701	BA1001	St4.2x22mm
	U 1.5	US 11.5100	US 0704

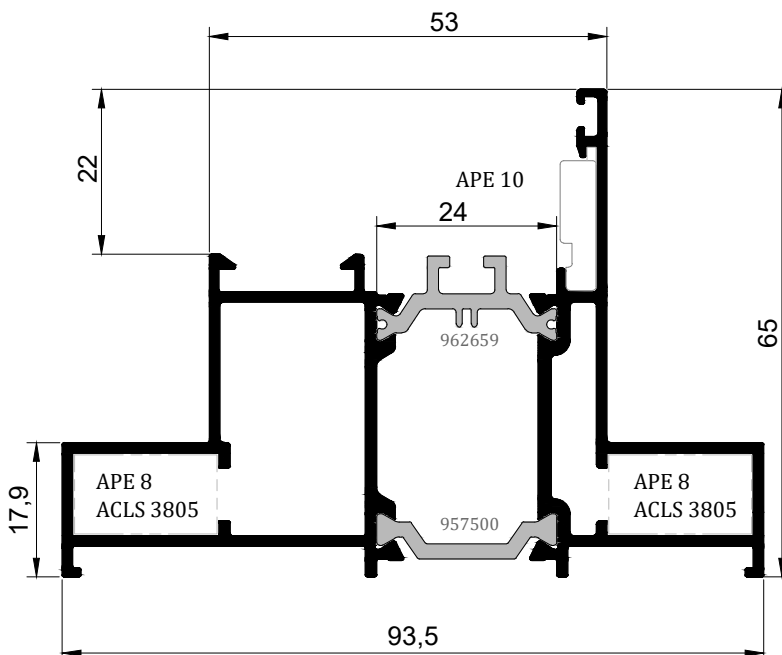

38 0004	Weight	$I_x \text{ cm}^4$	$I_y \text{ cm}^4$
	1,645 kg/mt	13,40	38,75
JOINTS	APE 10	ACLS 3805	APE 8
GASKETS & OTHER S38 & LS38	U 1.5	US 68	APE 900
	US 60	US 60	US 60

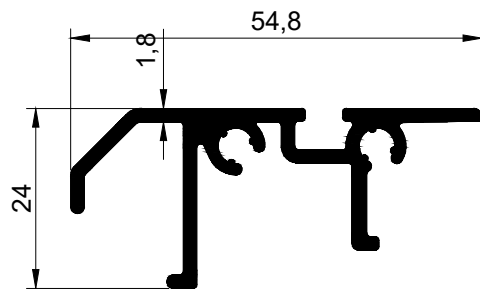

38 0005	Weight	$I_x \text{ cm}^4$	$I_y \text{ cm}^4$
	0,66 kg/mt	0,87	5,87
JOINTS	 ACLS 3811		
GASKETS & OTHER LS38	 LS 0701		

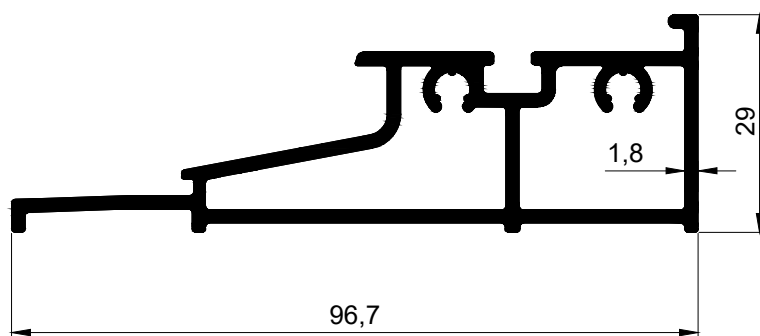

38 0006	Weight	$I_x \text{ cm}^4$	$I_y \text{ cm}^4$
	1,26 kg/mt	3,49	38,10
JOINTS	 ACLS 3811	 ACLS 3810	 ACLS 3813
GASKETS & OTHER LS 38	 LS 0701	 ACLS 3812	 ULS 3805
			 St 4.2x13mm

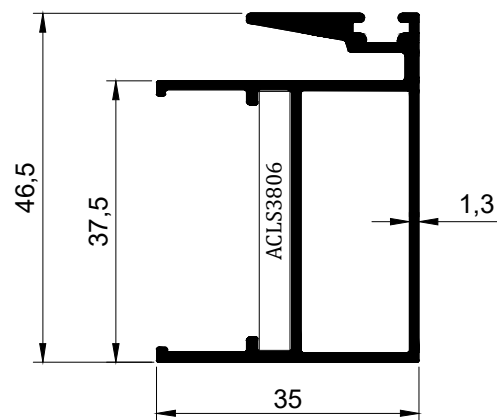
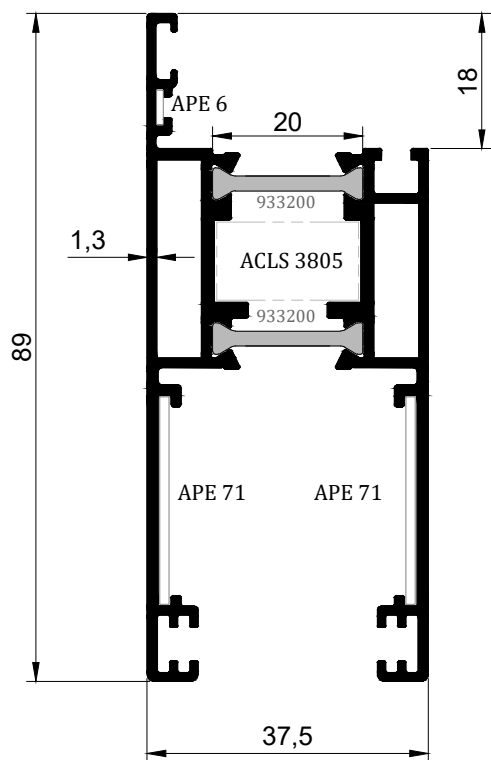





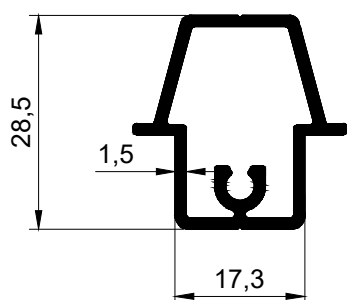

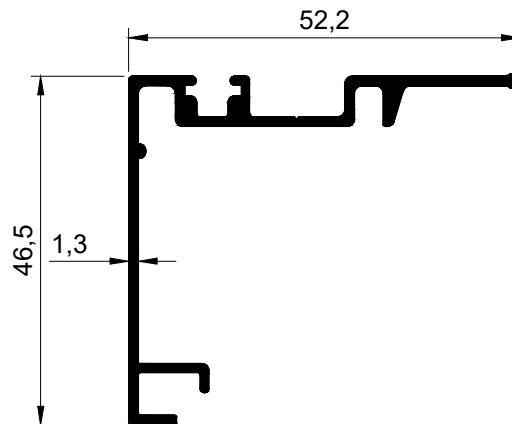

38 0007	Weight	$I_x \text{ cm}^4$	$I_y \text{ cm}^4$
	1,39 kg/mt	10,14	41,81
JOINTS	ACLS 3805	APE 71	APE 6
GASKETS & OTHER S38	U 1.5	US 11.5100	TZ 5,5
GASKETS & OTHER LS38	U 1.5	US 11.5100	US 0702
		ACLS 3807	UR 3809

38 0008	Weight	$I_x \text{ cm}^4$	$I_y \text{ cm}^4$
	0,7 kg/mt	2,66	7,37
JOINTS	ACLS3806		
GASKETS & OTHER	U 1.5	TZ 5,5	AC3804
	St 4.2x19mm		St 4.2x25mm





38 0010	Weight	$I_x \text{ cm}^4$	$I_y \text{ cm}^4$
	0,453 kg/mt	1,48	0,91
GASKETS & OTHER LS38 & S38	ULS 3807	ACLS 3808	St 4.2x19mm

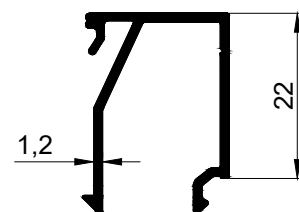
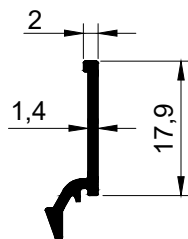

38 0013	Weight	$I_x \text{ cm}^4$	$I_y \text{ cm}^4$
	0,523 kg/m	4,59	4,58
GASKETS & OTHER S38	 ULS 3806	 TZ 5,5	
	 ACLS 3804	 St 4.2x19mm	
GASKETS & OTHER LS38	 ULS 3806	 TZ 5,5	
	 ACLS 3803	 St 4.2x19mm	



38 0011	Weight	$I_x \text{ cm}^4$	$I_y \text{ cm}^4$
	0,12 kg/mt	0,23	0,02
GASKETS & OTHER S38 & LS38	 U 1.5		

375 0530	Weight	$I_x \text{ cm}^4$	$I_y \text{ cm}^4$
	0,260 kg/m	0,73	0,5
GASKETS & OTHER S38 & LS38	 U 1.5		

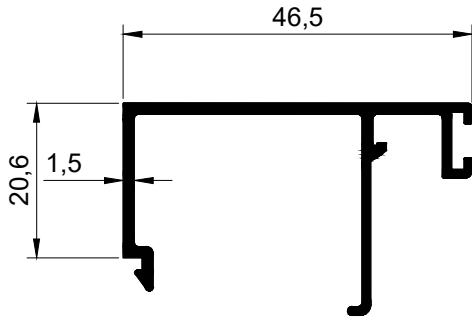

38 0012	Weight	$I_x \text{ cm}^4$	$I_y \text{ cm}^4$
	0,45 kg/mt	0,79	4,08
GASKETS & OTHER S38 & LS38	 TZ 5,5		

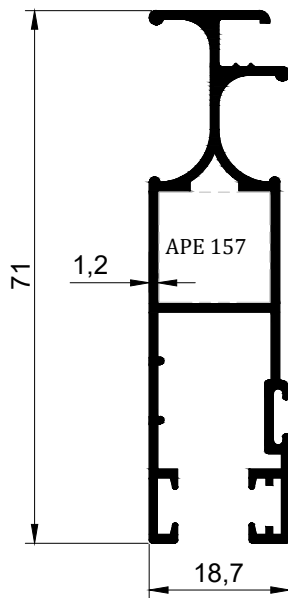

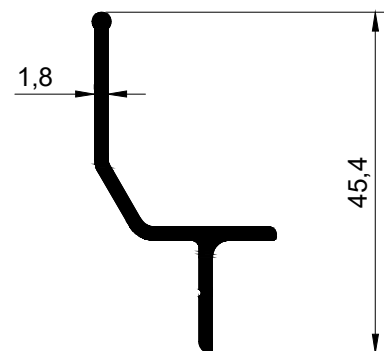

300 0128	Weight	$I_x \text{ cm}^4$	$I_y \text{ cm}^4$	
	0,811 kg/m	11,79	1,07	
JOINTS	 APE 157			
GASKETS & OTHER S38 & LS38	 7mm gasket	 TZ 5,5	 TZ 7	 A0103



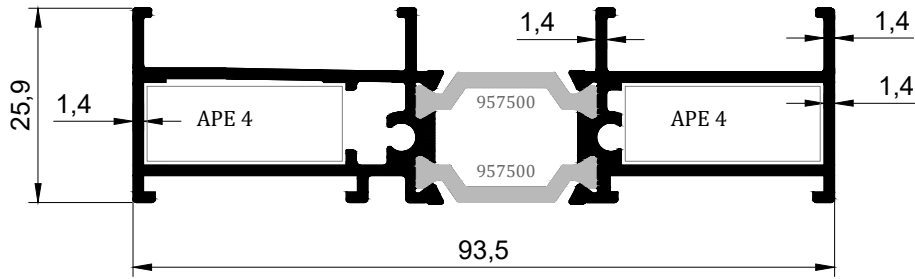

07 0012	Weight	$I_x \text{ cm}^4$	$I_y \text{ cm}^4$
	0,311 kg/m	1,52	0,61
GASKETS & OTHER S38 & LS38	 St 4.2x19mm		



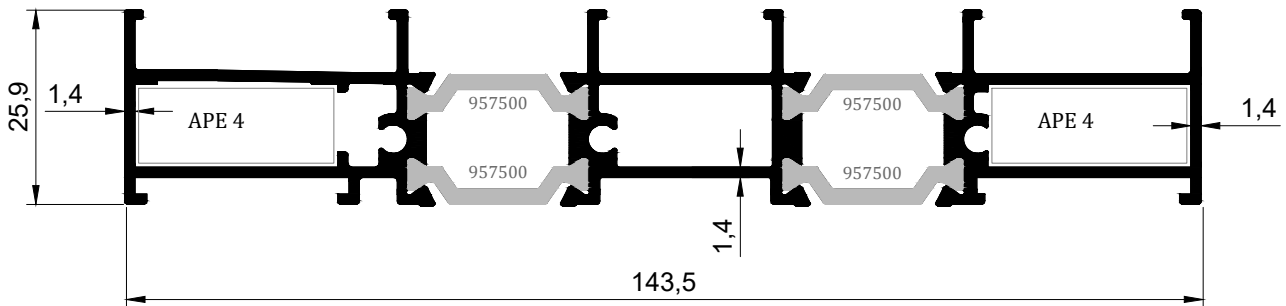

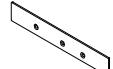
38 0014	Weight	$I_x \text{ cm}^4$	$I_y \text{ cm}^4$
	1.29 kg/mt	2,21	39,37
JOINTS S38 & LS38	 APE 4	 ---	 St 4.2x22mm



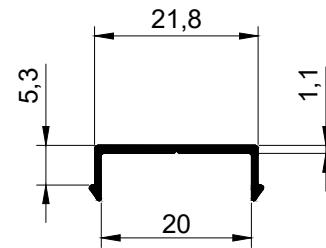
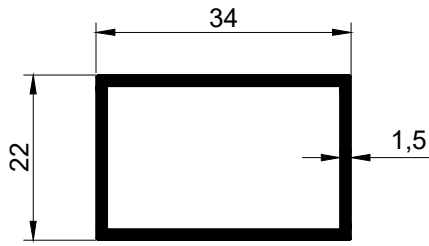





38 0015	Weight	$I_x \text{ cm}^4$	$I_y \text{ cm}^4$
	1.99 kg/mt	3,39	128,81
JOINTS S38 & LS38	 APE 4	 ---	 St 4.2x22mm

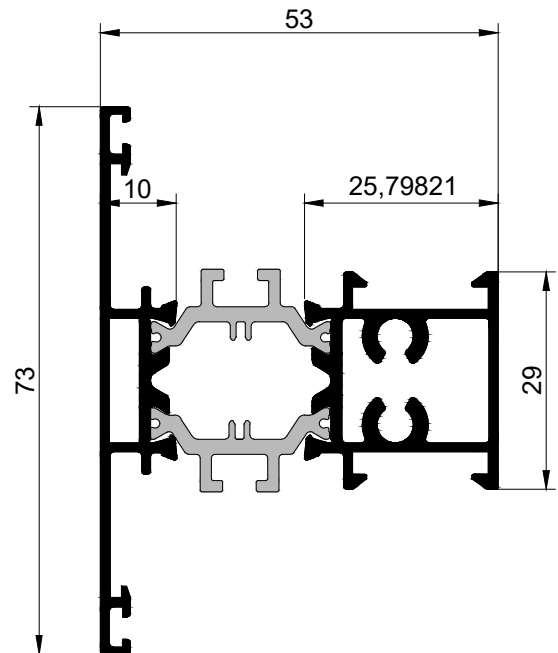
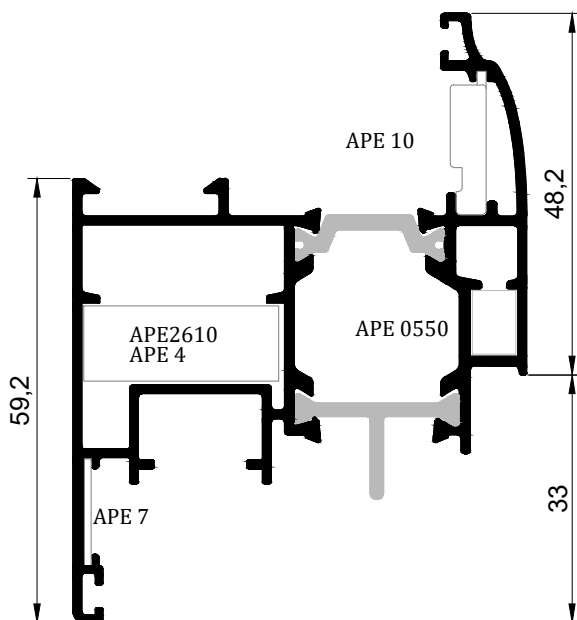

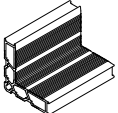
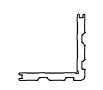



38 0016	Weight	$I_x \text{ cm}^4$	$I_y \text{ cm}^4$
	0,429 kg/m	1,24	2,48
GASKETS & OTHER S38 & LS38  St 4.2x19mm			

38 0017	Weight	$I_x \text{ cm}^4$	$I_y \text{ cm}^4$
	0,097 kg/m	0,01	0,02
GASKETS & OTHER S38 & LS38  St 4.2x19mm			



530 0326	Weight	$I_x \text{ cm}^4$	$I_y \text{ cm}^4$
	1,364 kg/mt	13,36	21,25
JOINTS  APE 2610  APE 0550  APE 4  APE 7	GASKETS & OTHER S38 & LS38  US 60  APE 900  US 68		

530 0205	Weight	$I_x \text{ cm}^4$	$I_y \text{ cm}^4$
	1,276 kg/mt	9,27	15,76
GASKETS & OTHER S38 & LS38  US 60  APE 900  US 68  St 4.2x25mm			

SLIDE 38
SYSTEM

SECTIONS



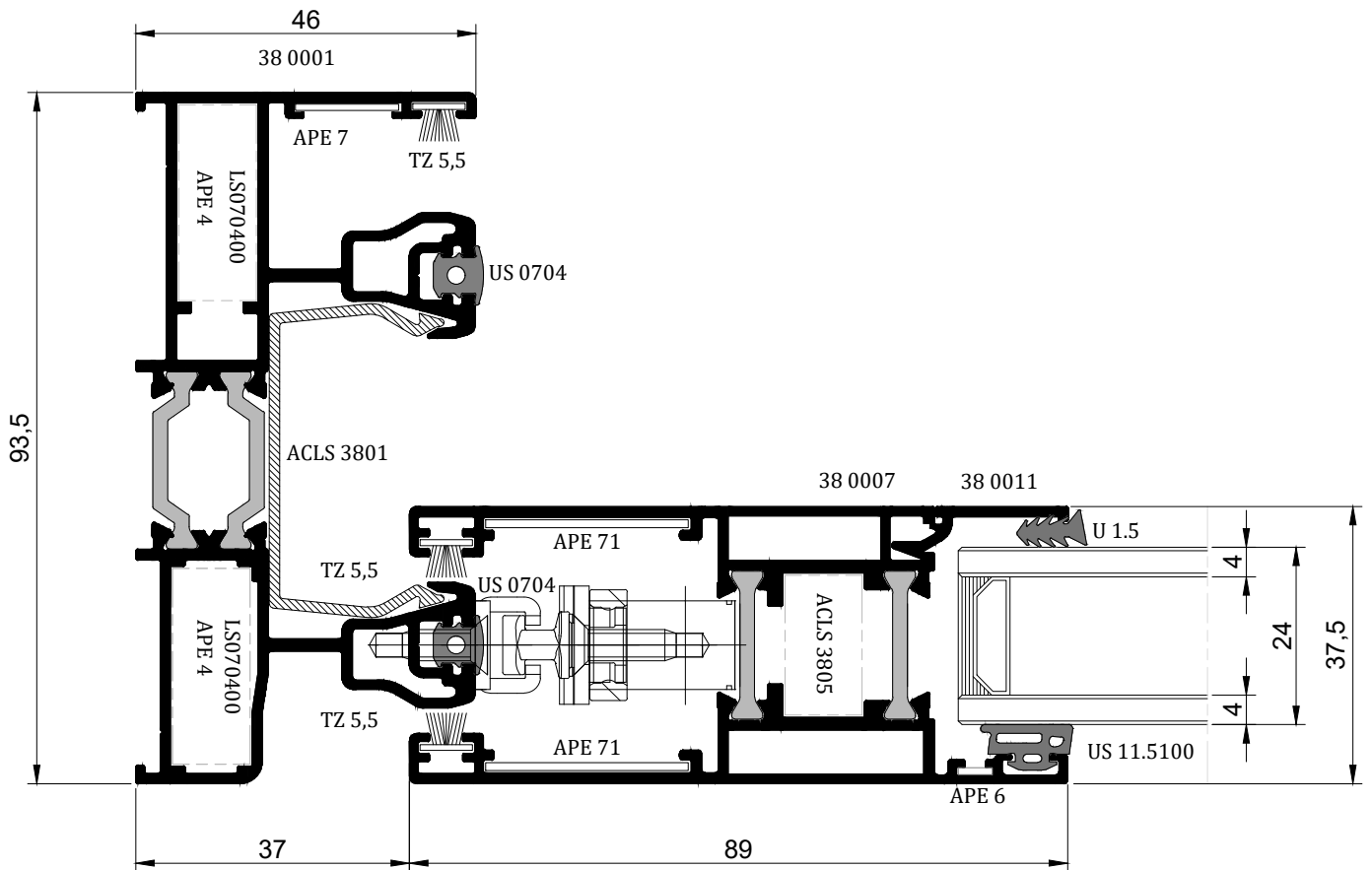
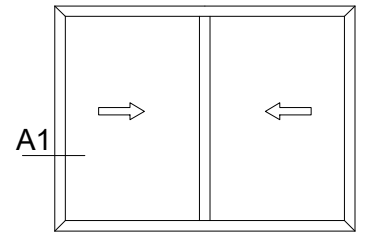

A1

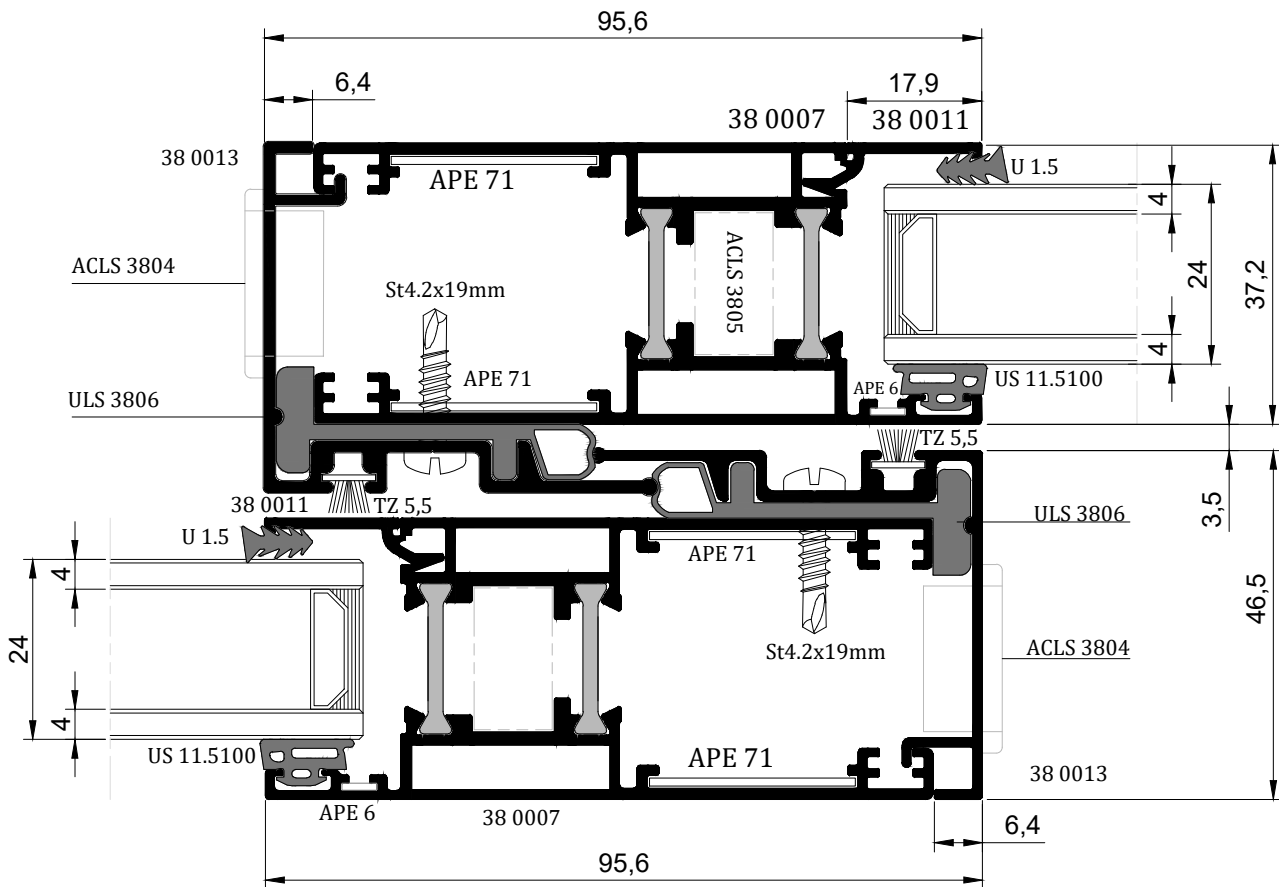
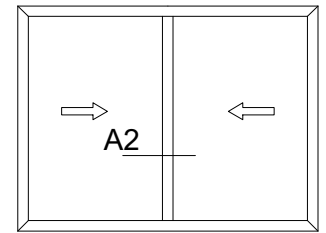

A2

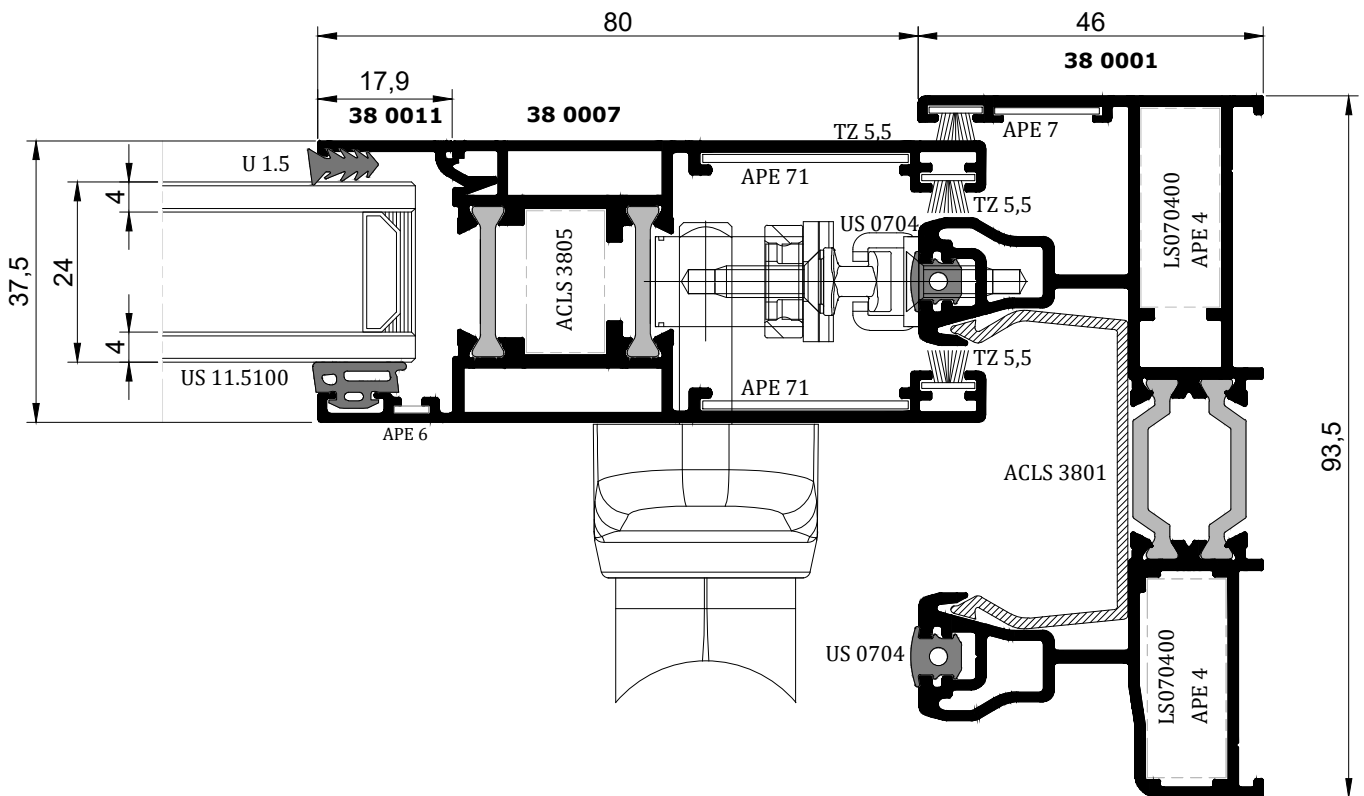
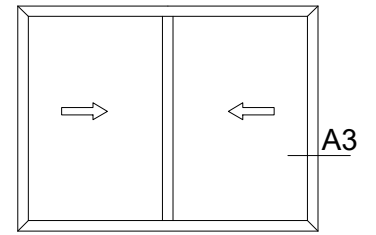

A3

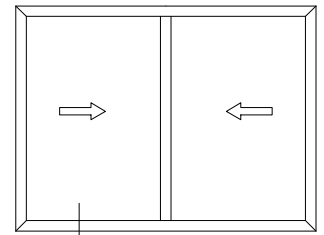

A4

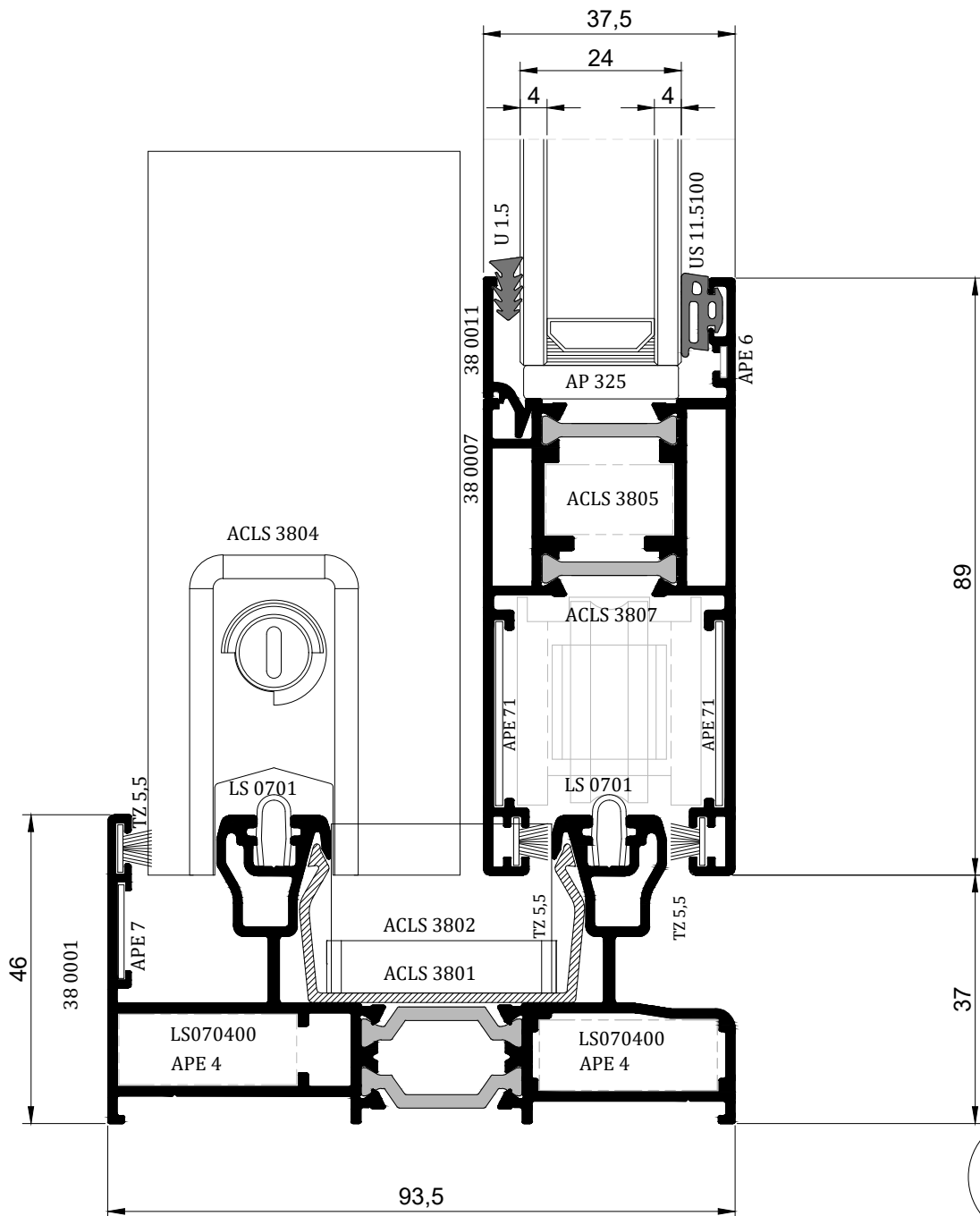

A4

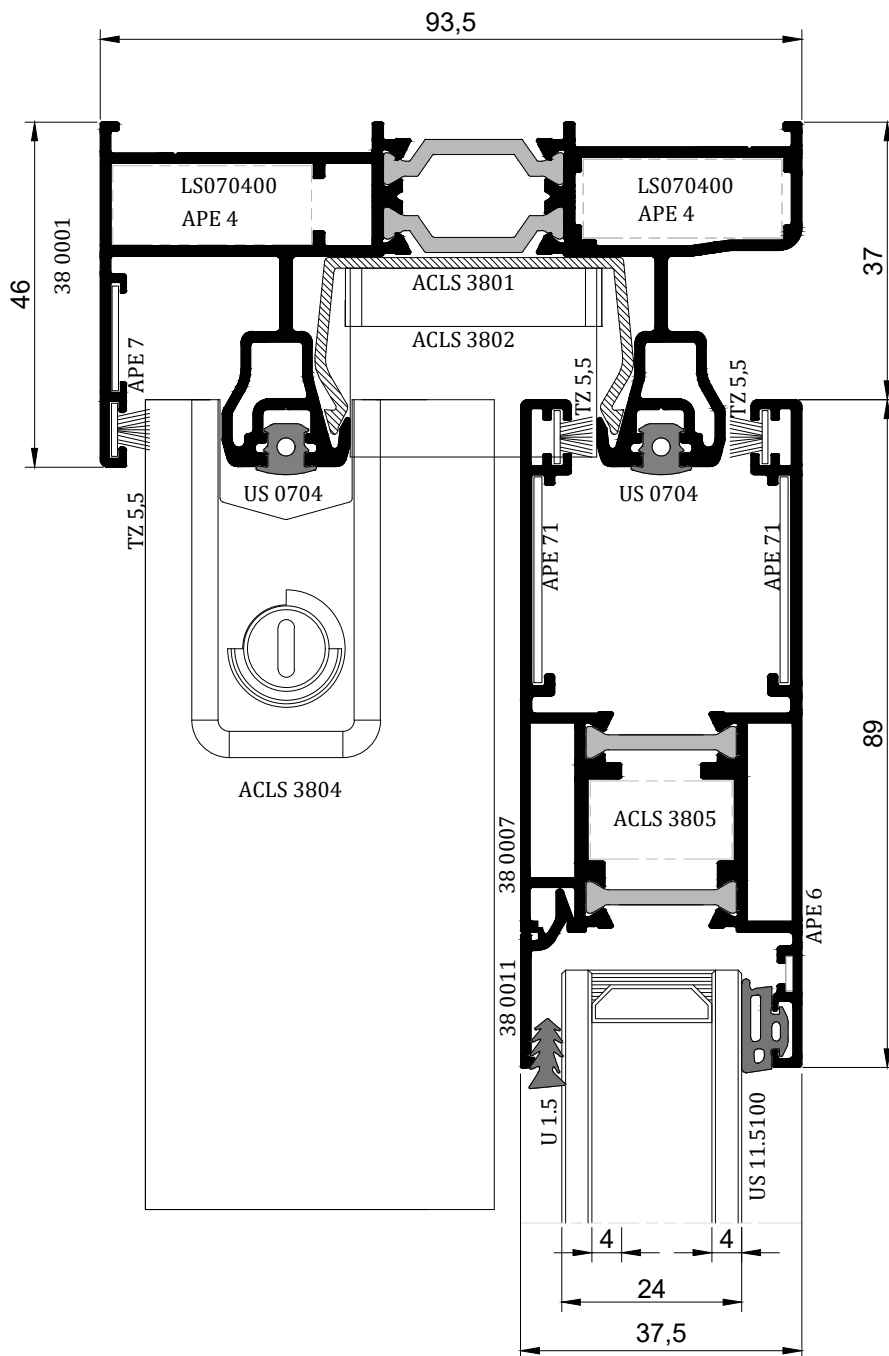
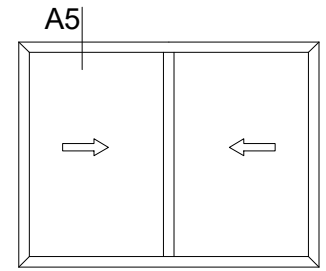

A5

Drainage profil

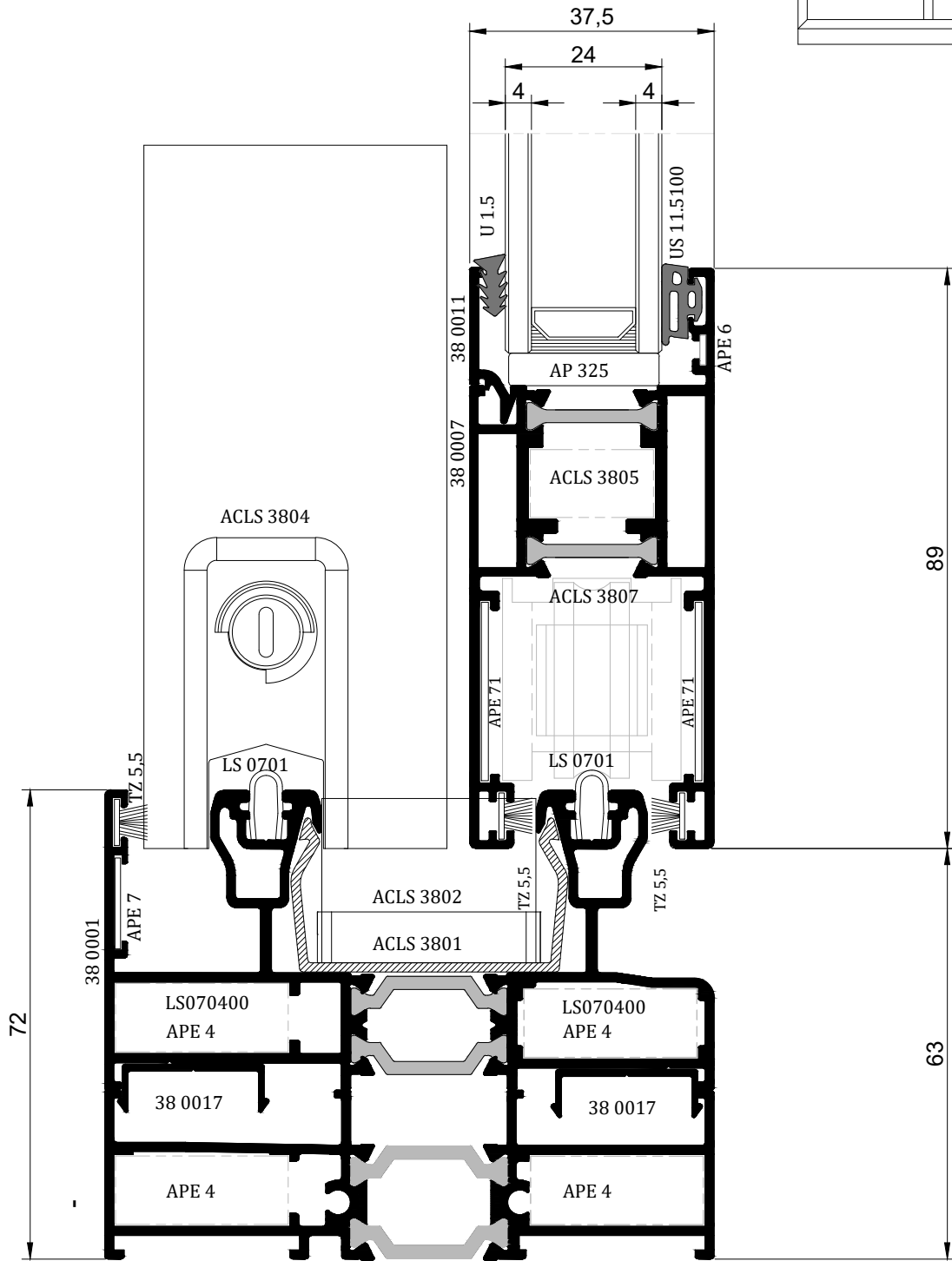
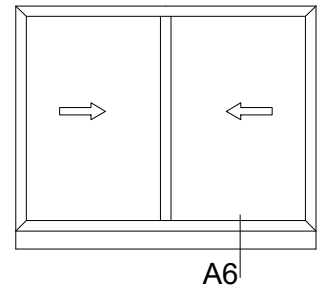

A6

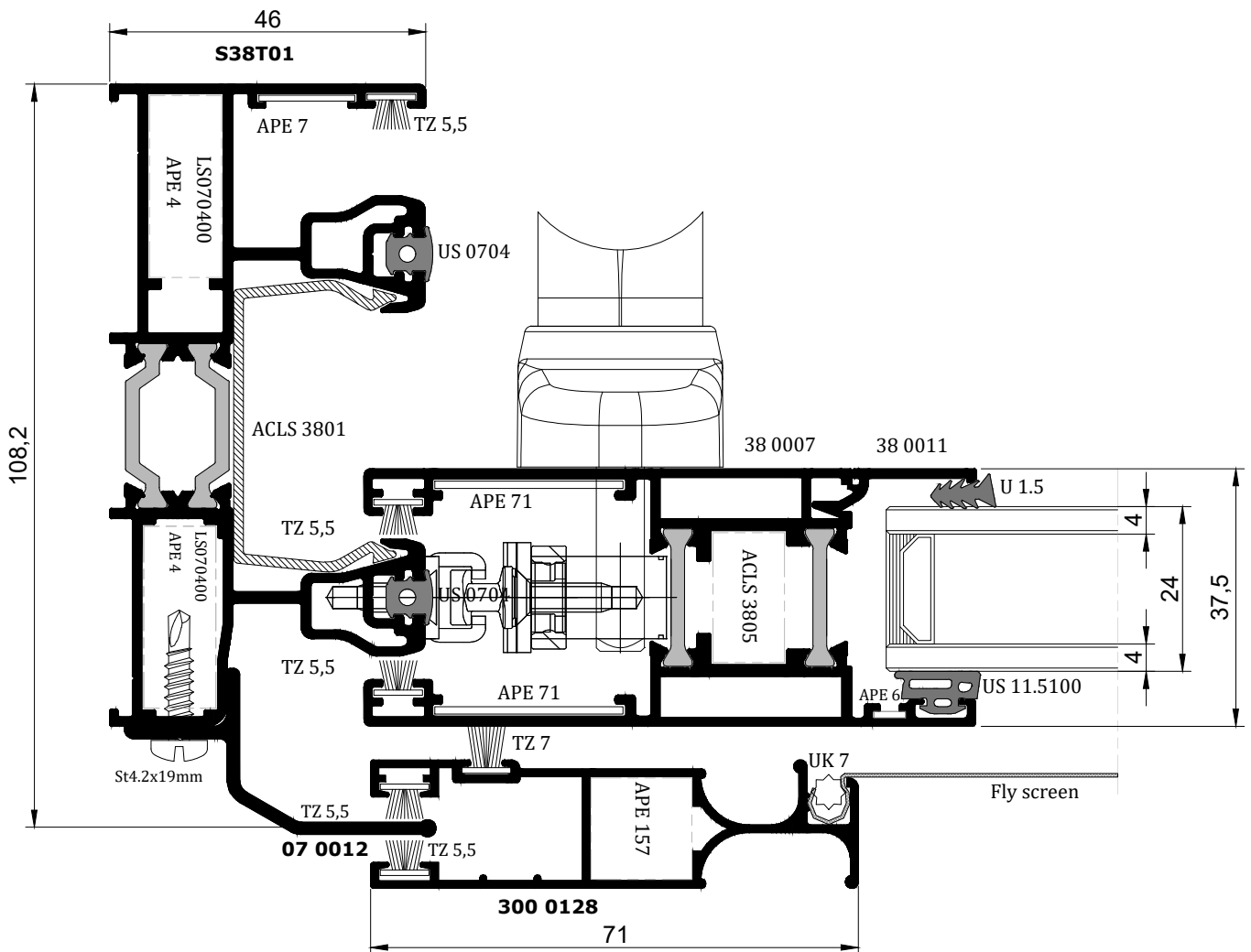
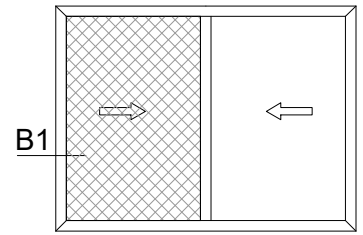

B1

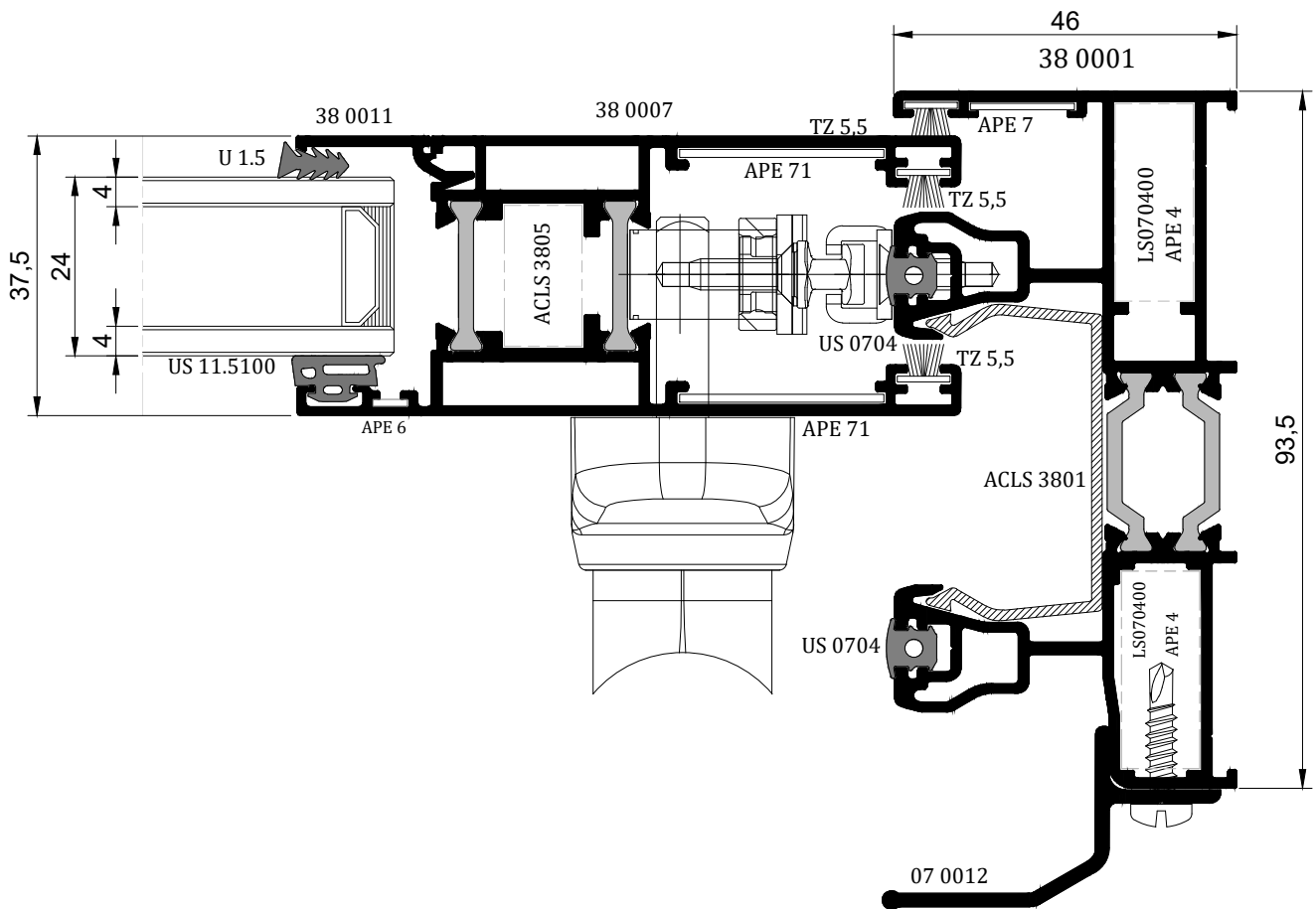
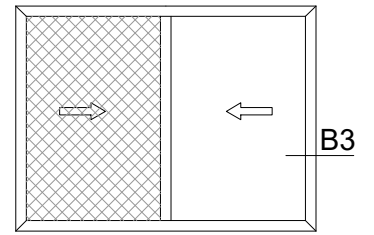

B3

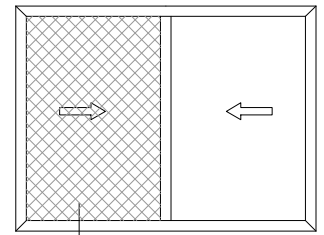

B4

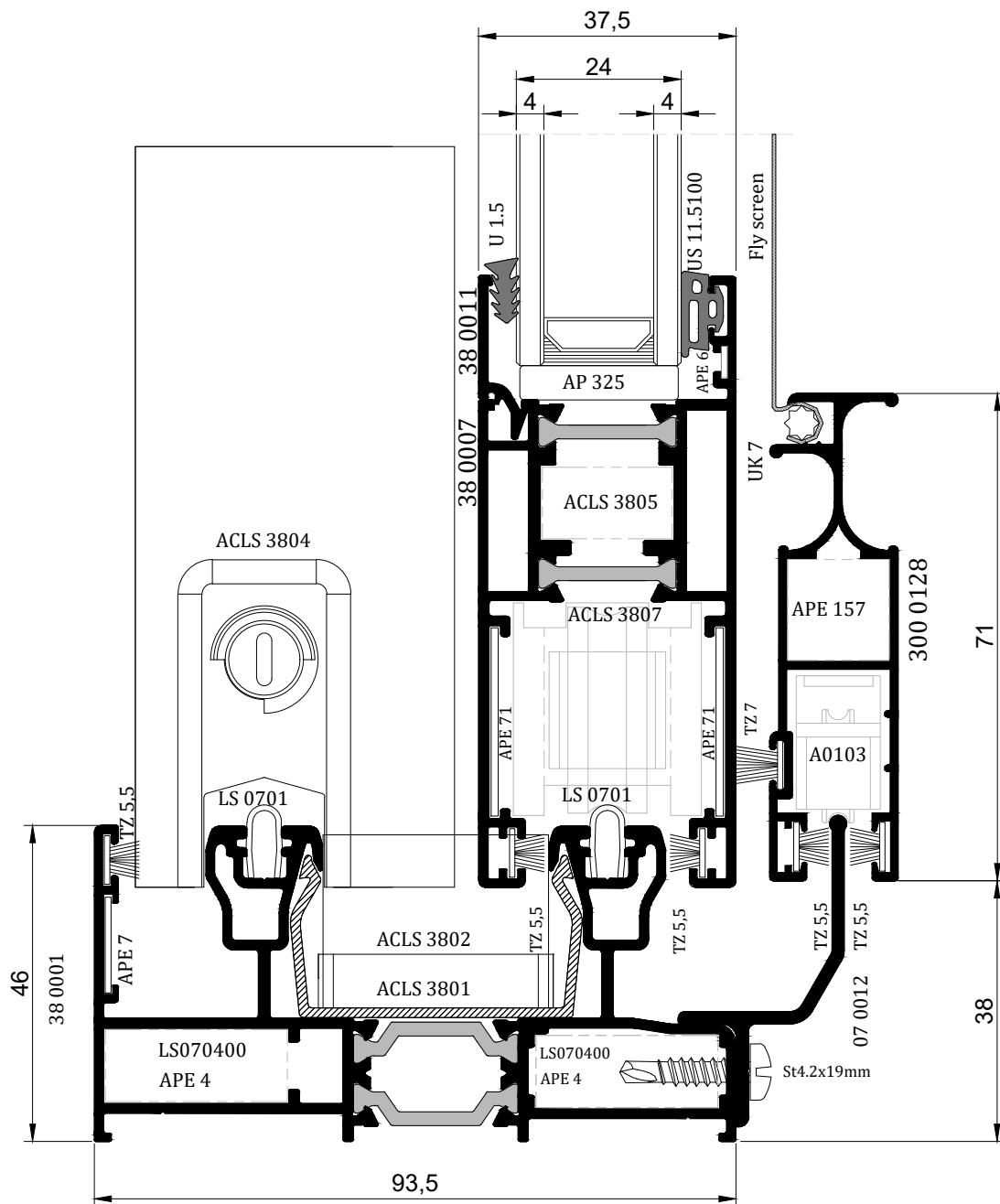

B4

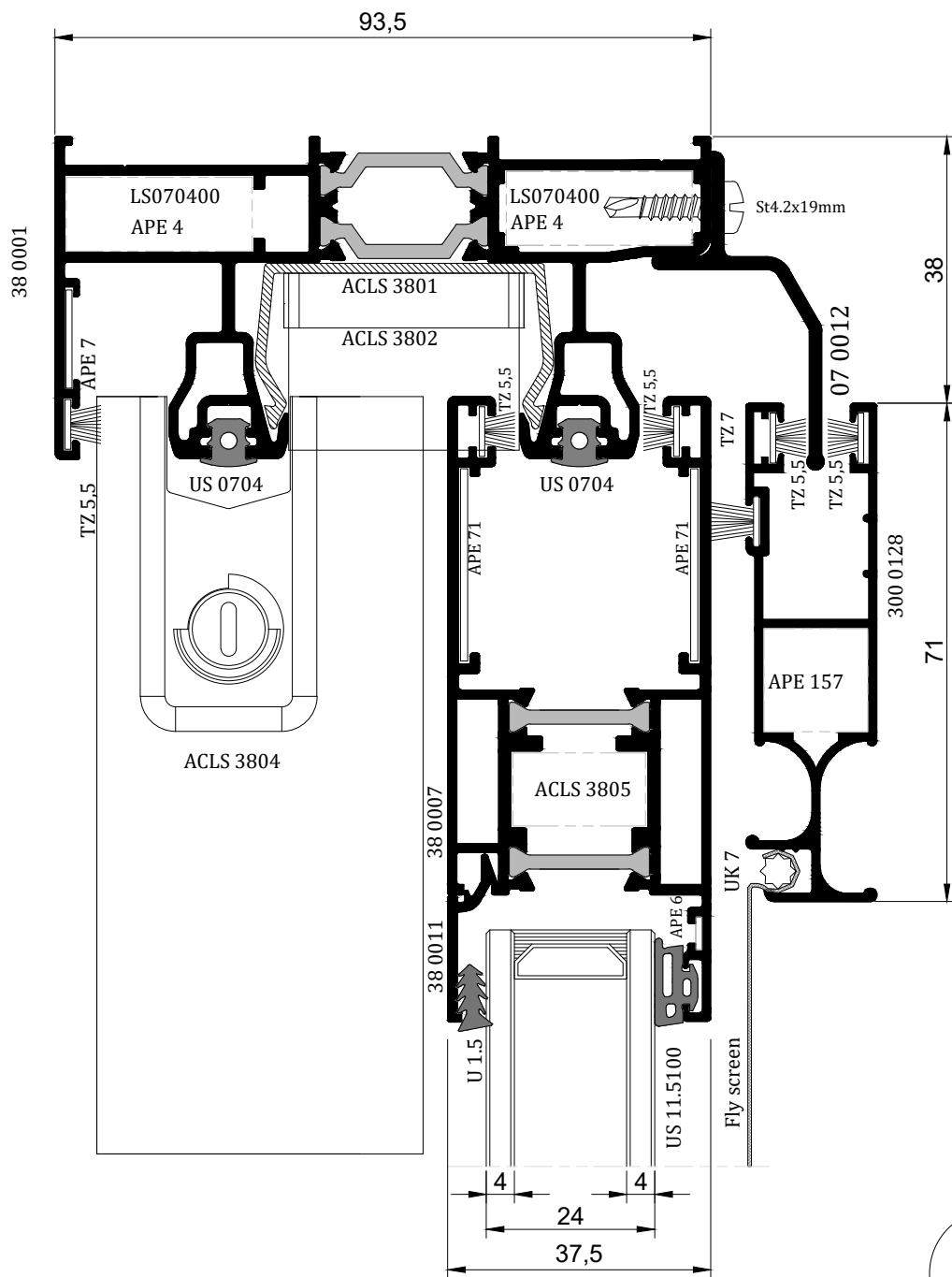
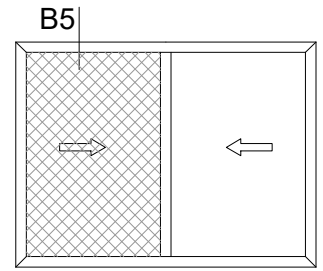

B5

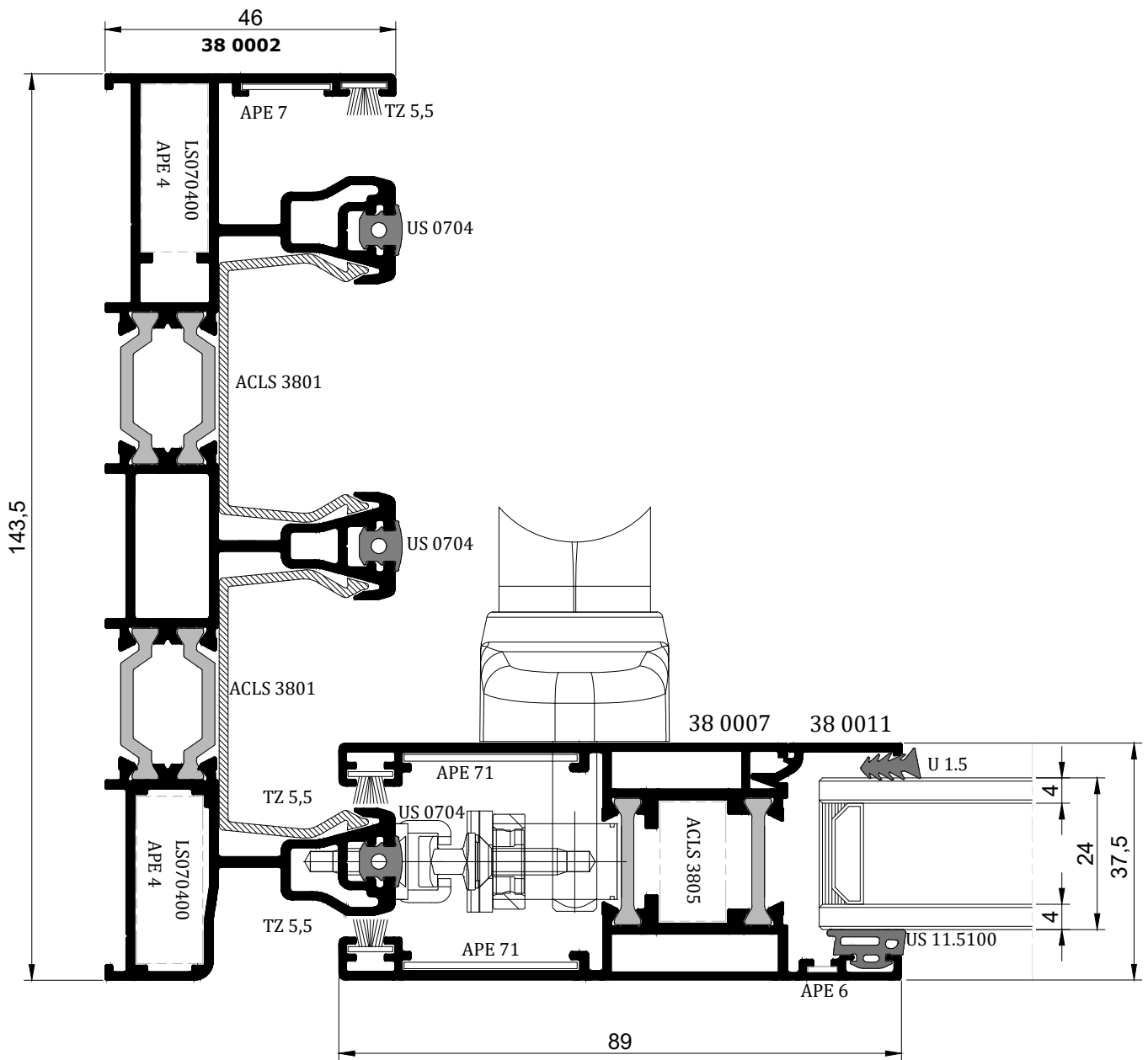
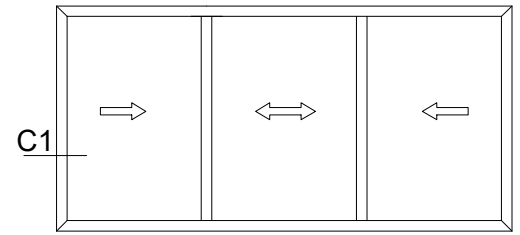

C1

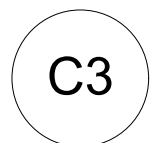
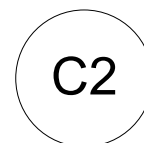
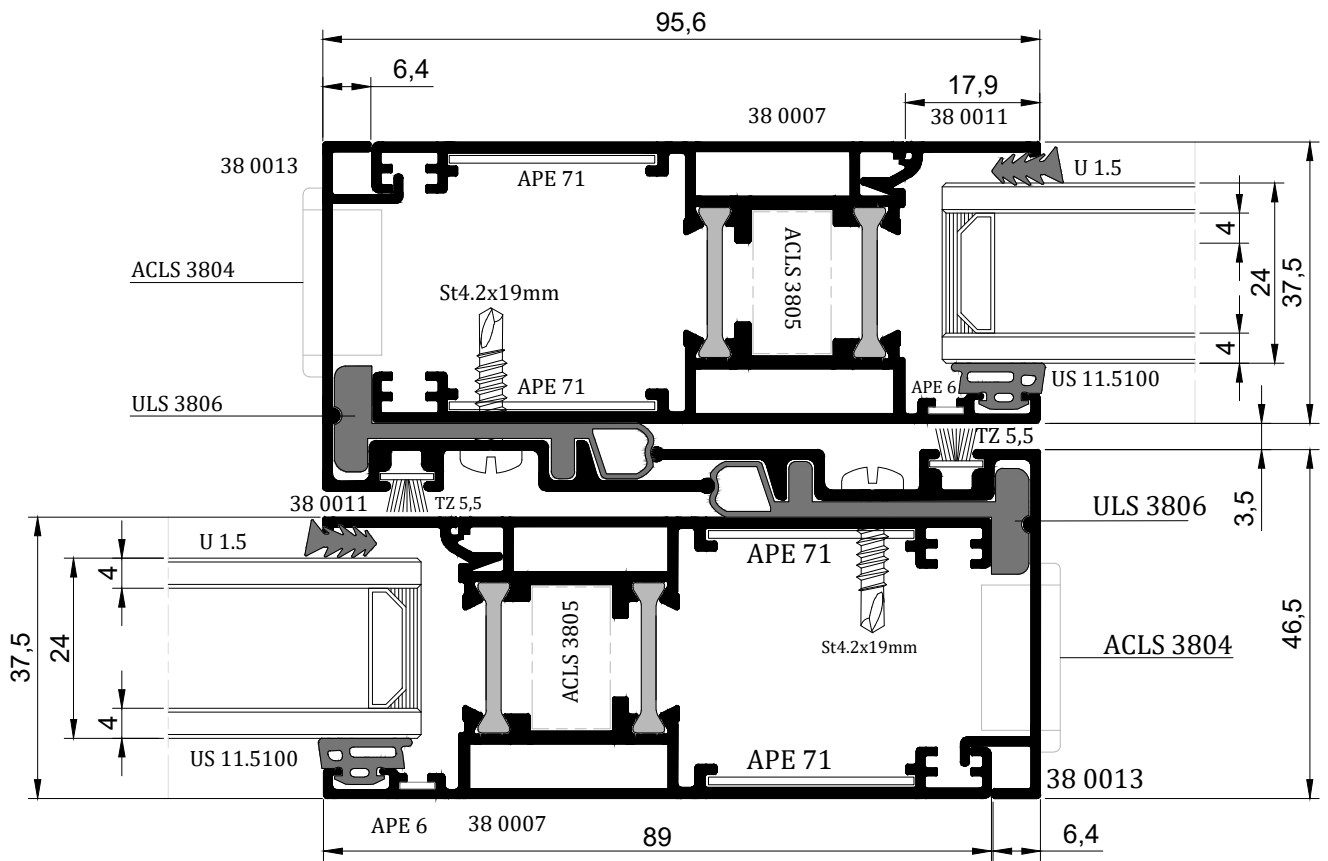
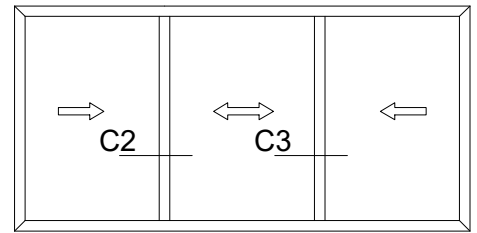

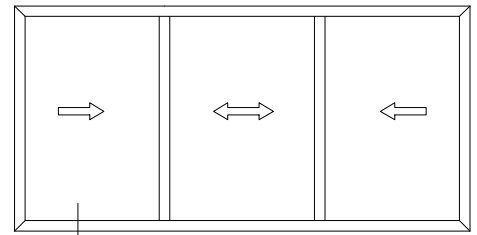

C5

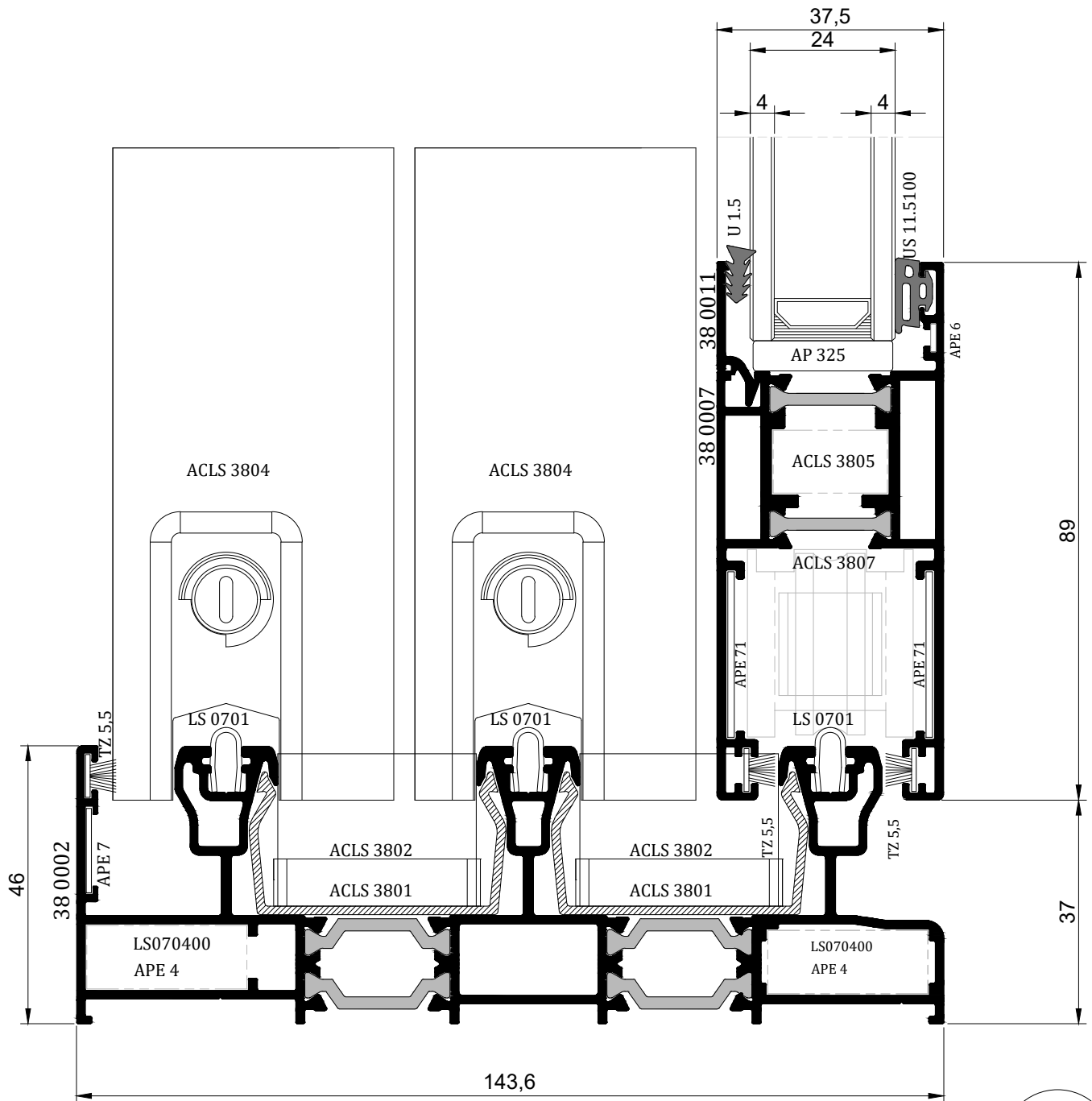

C5

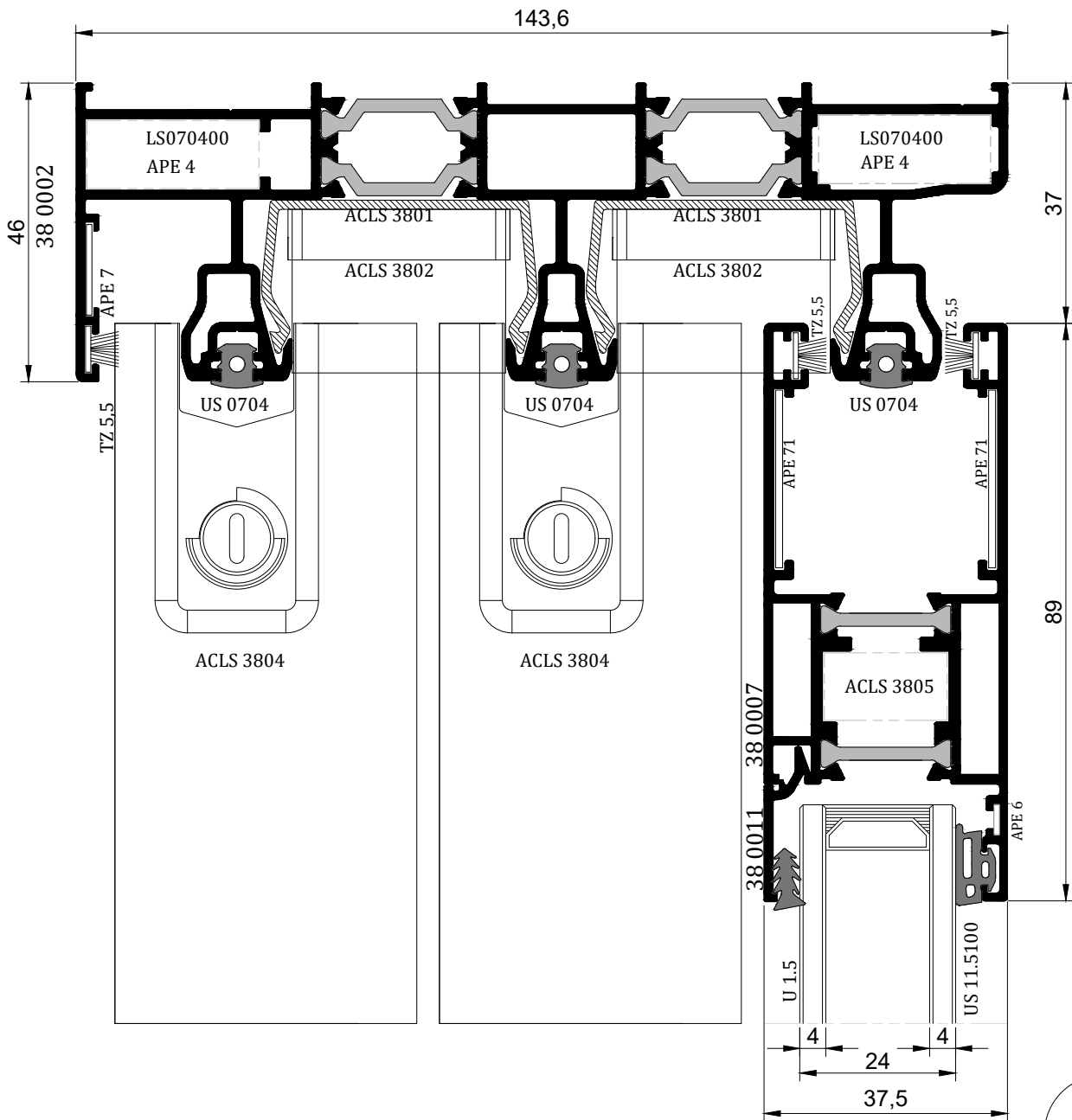
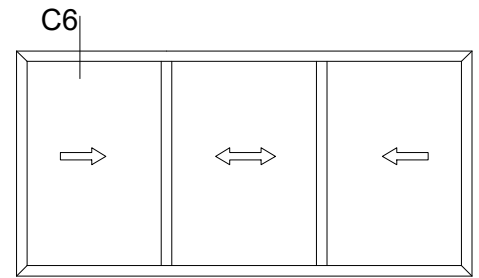

C6

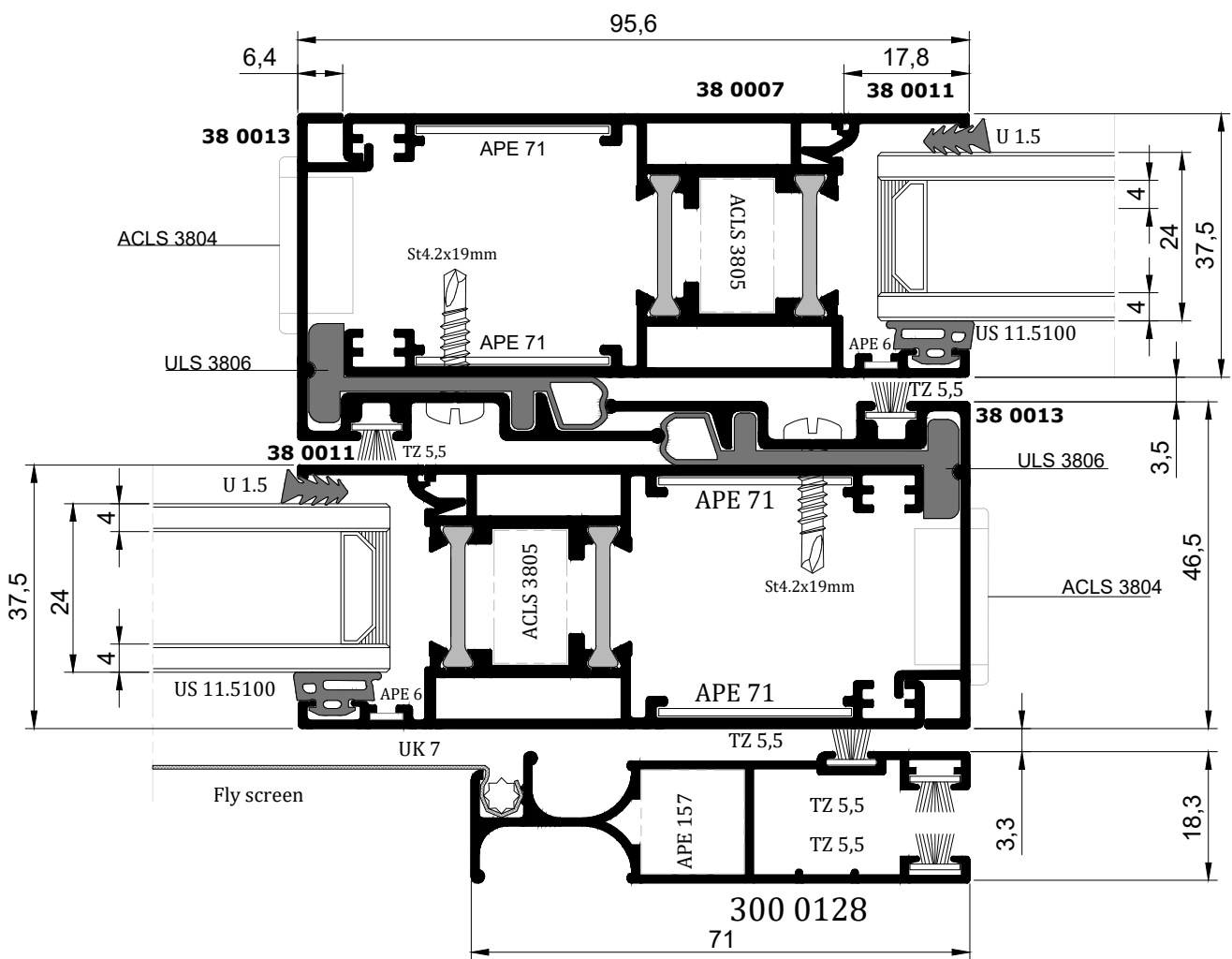
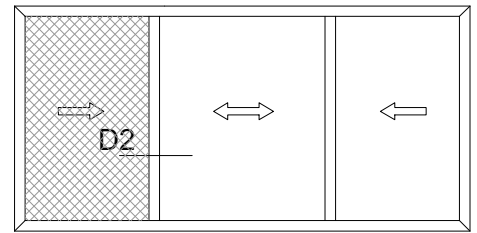

D2

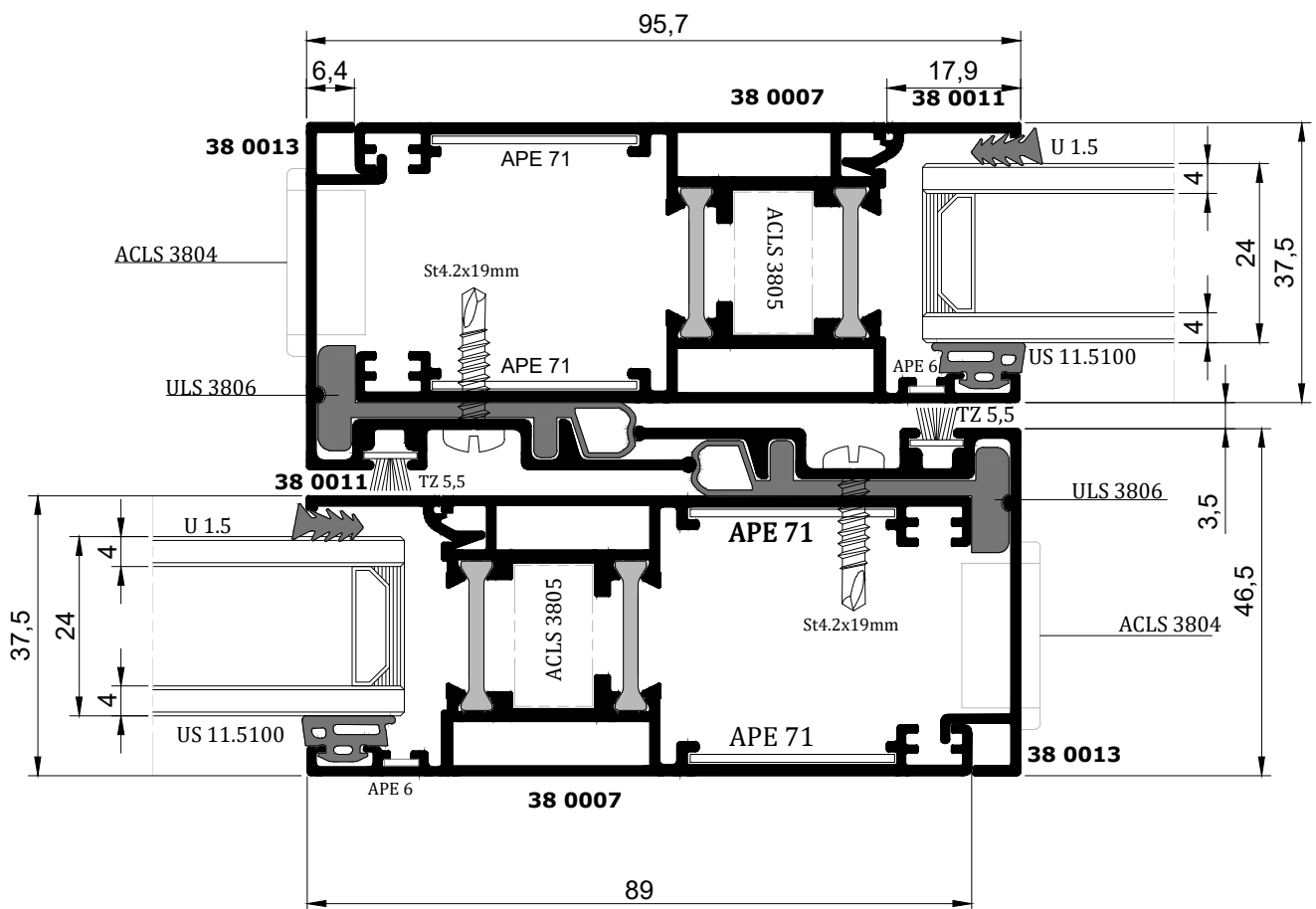
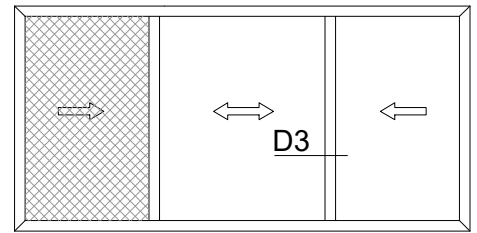

D3

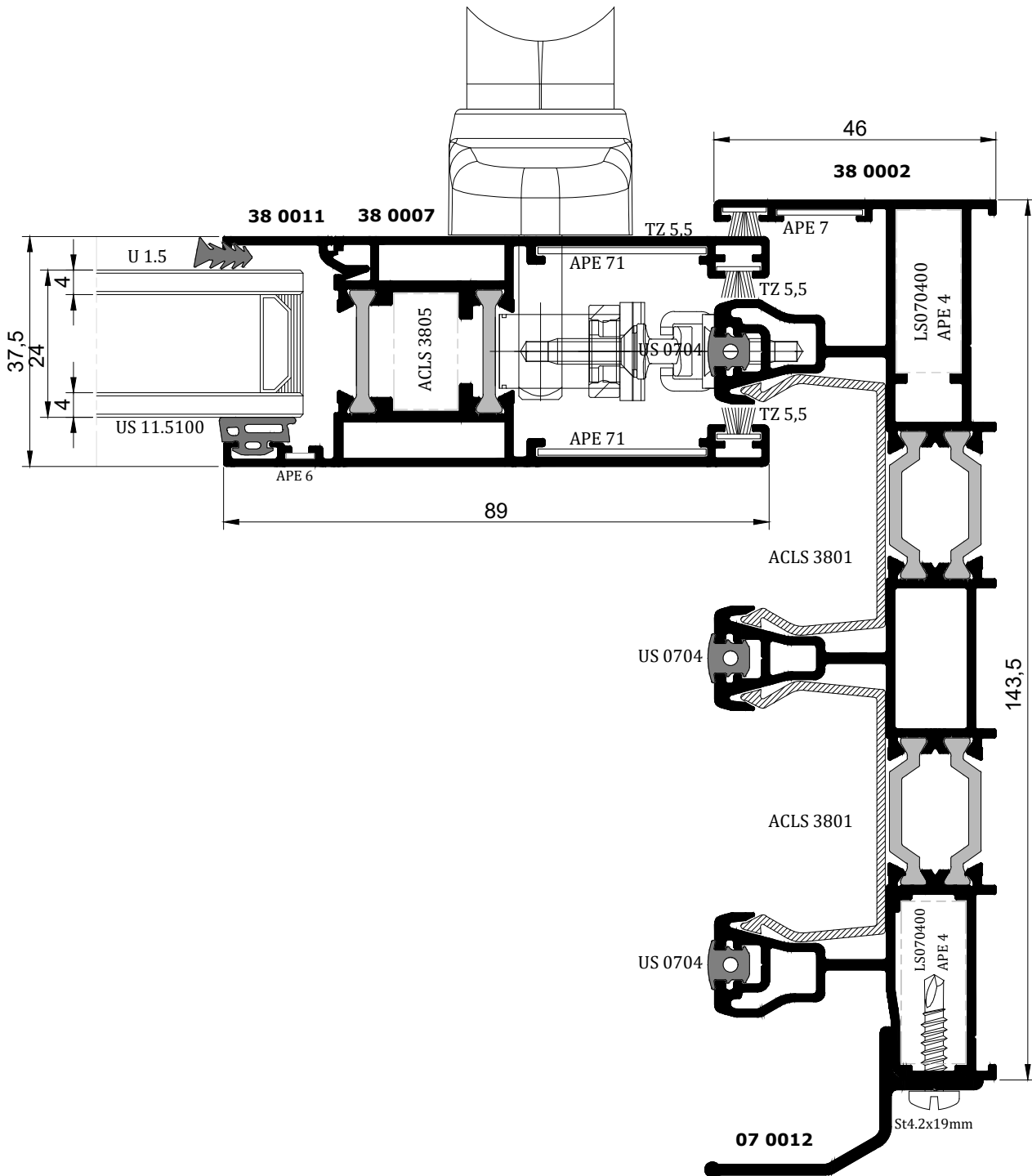
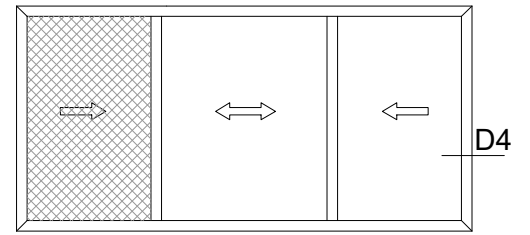

D4

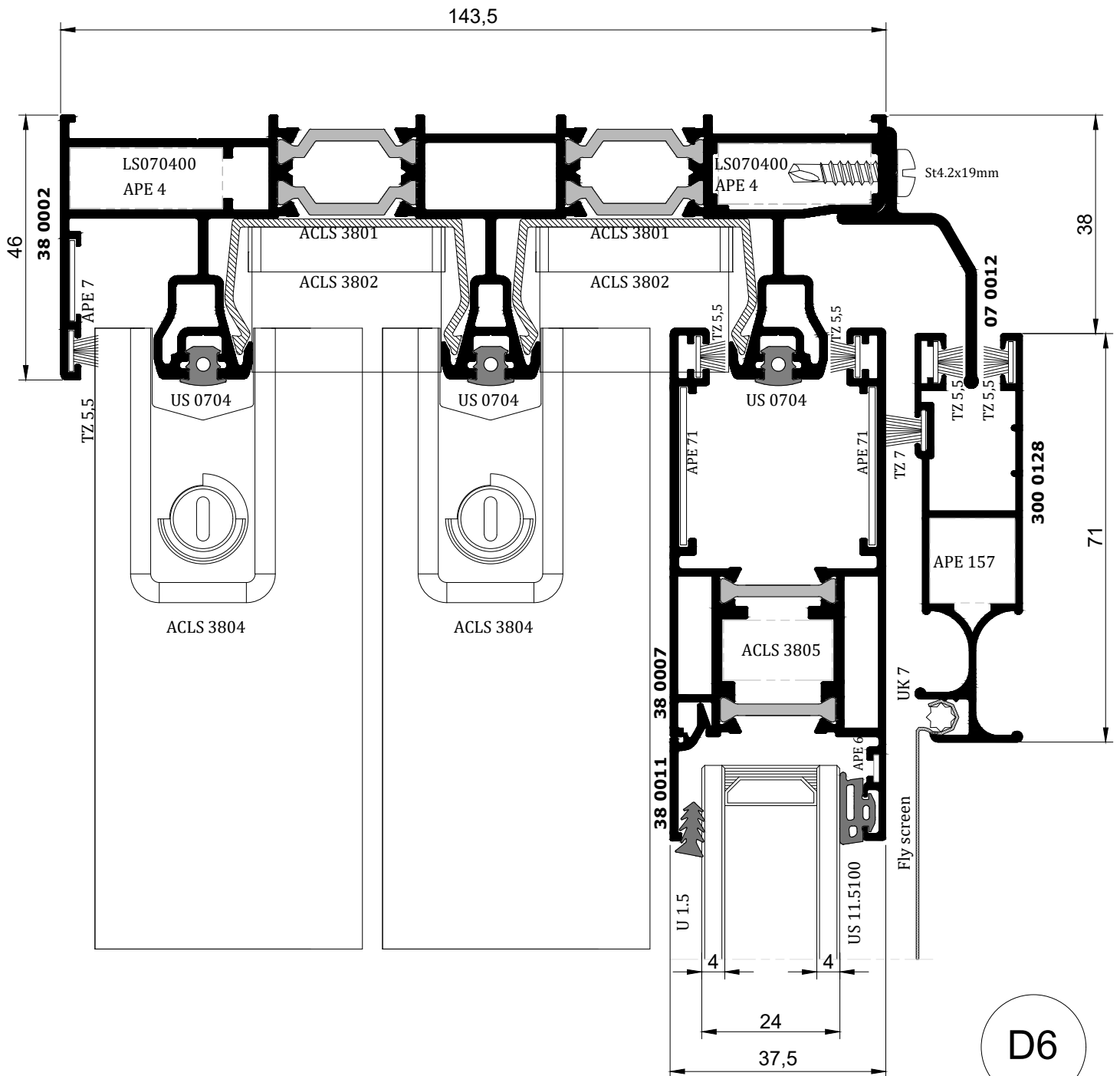
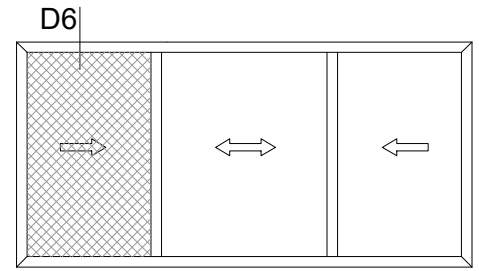

D6

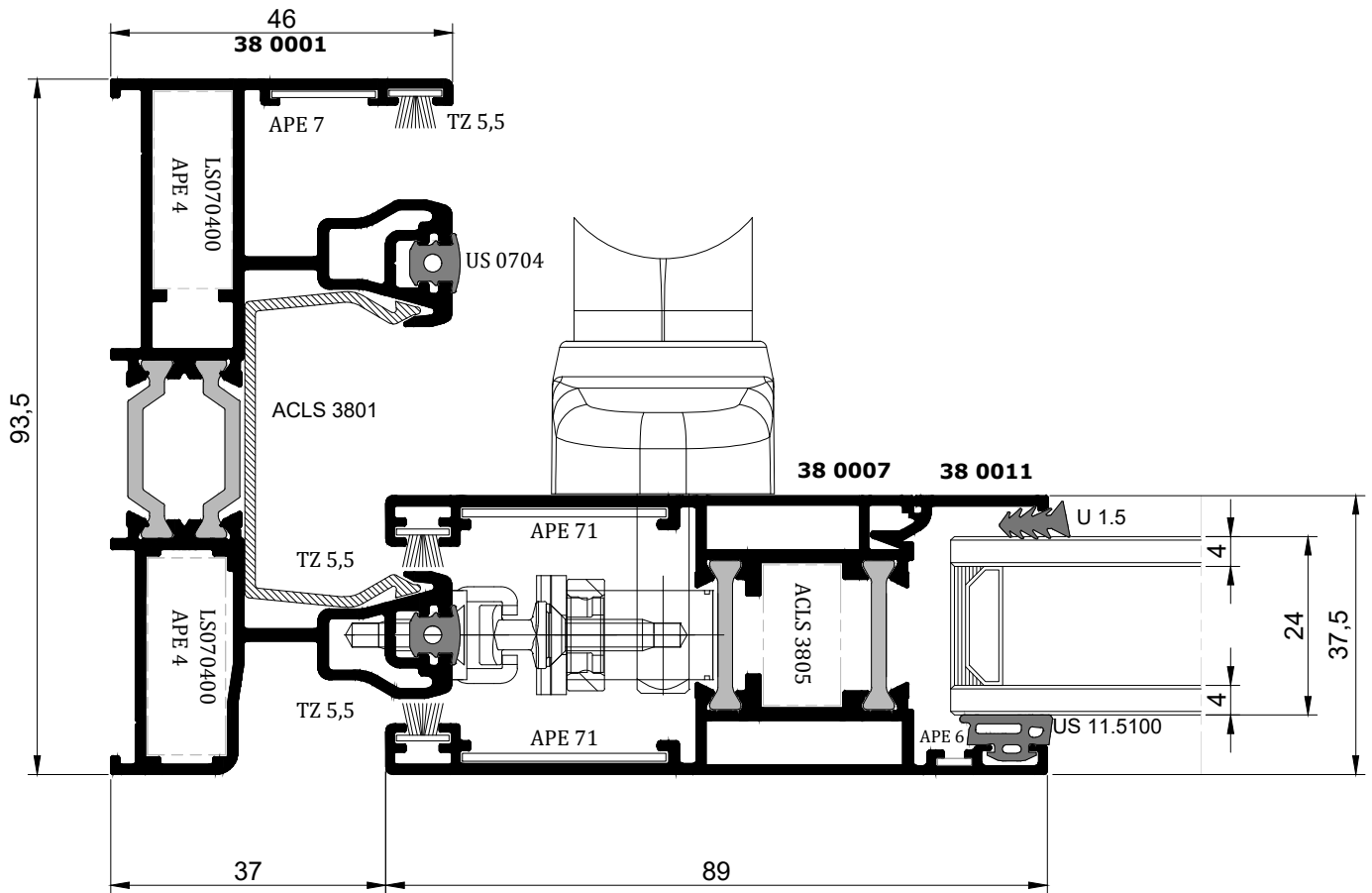
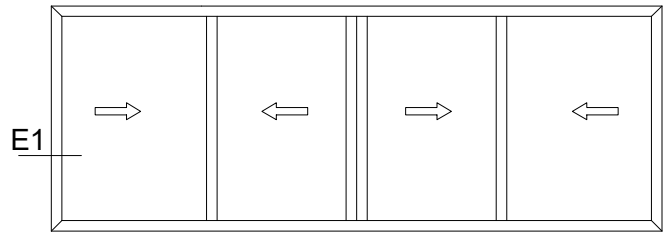

E1

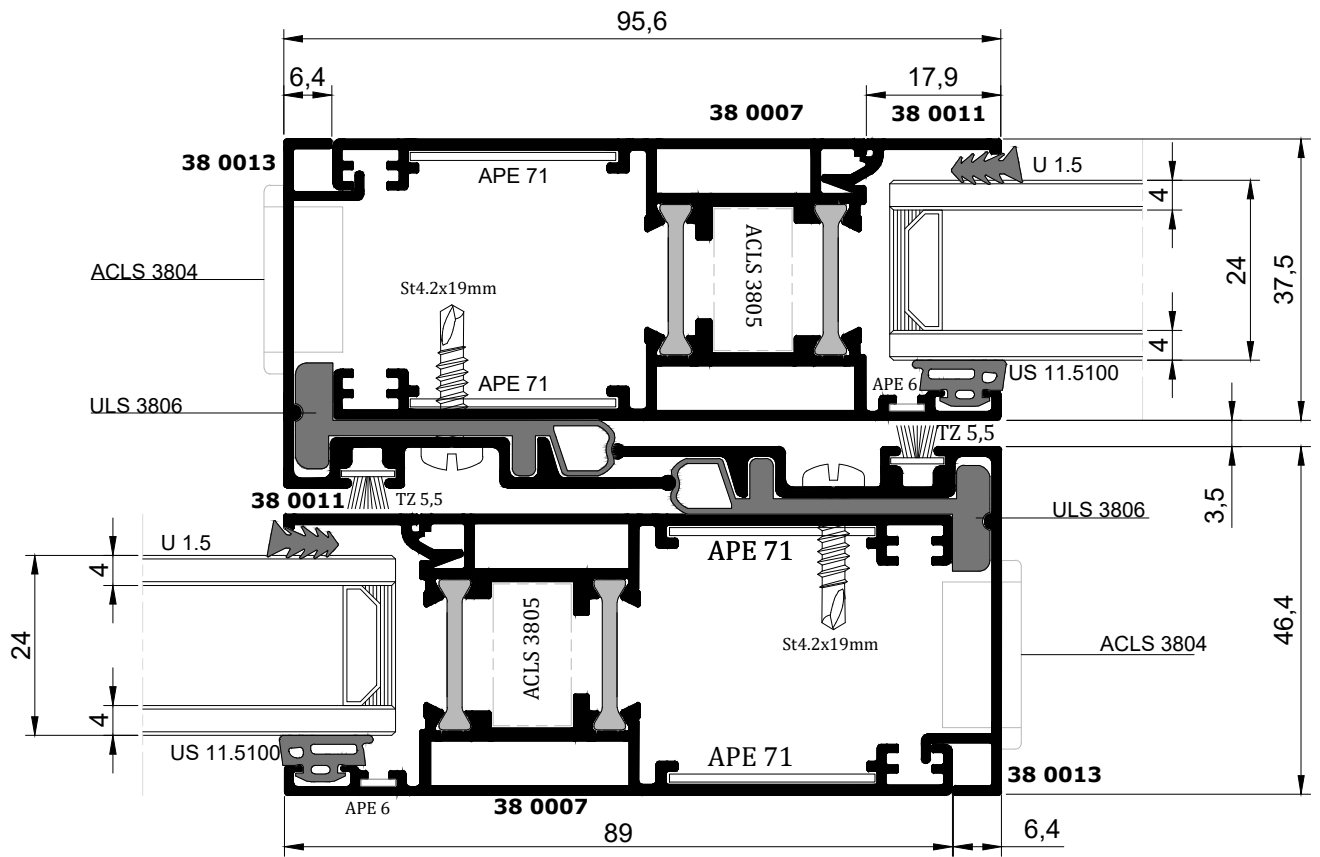
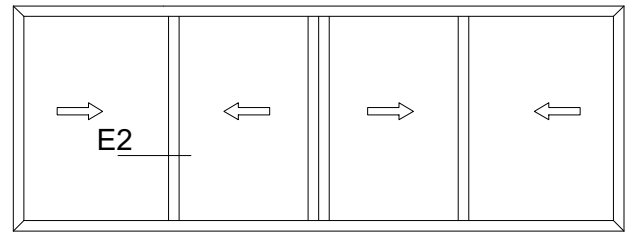

E2

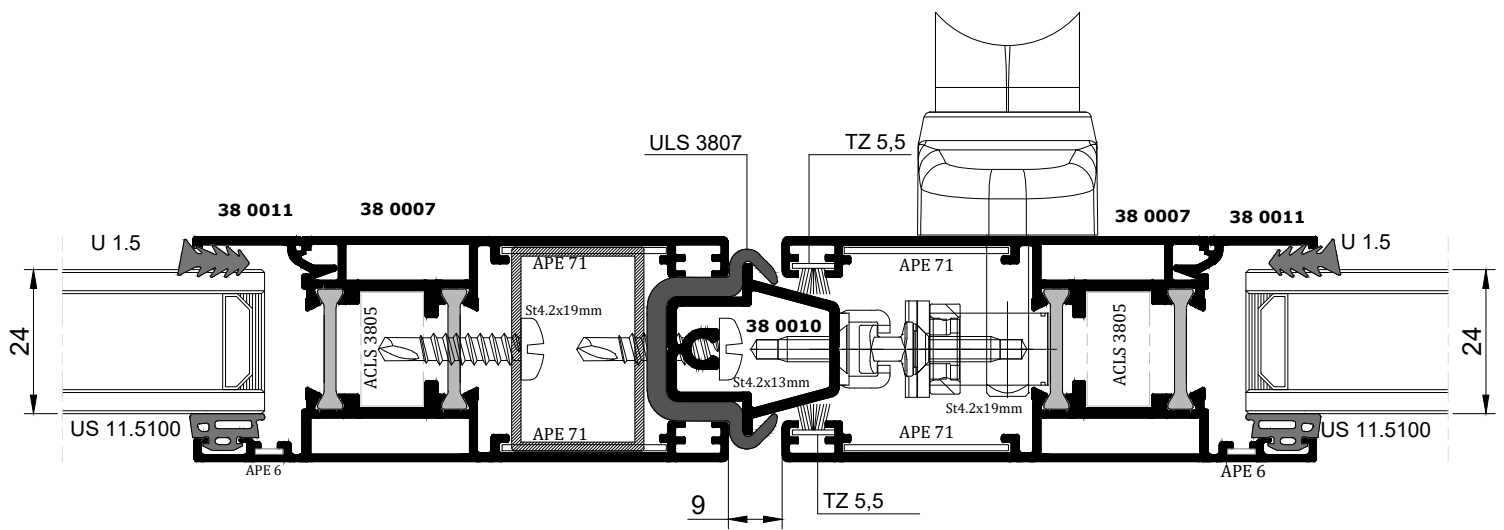
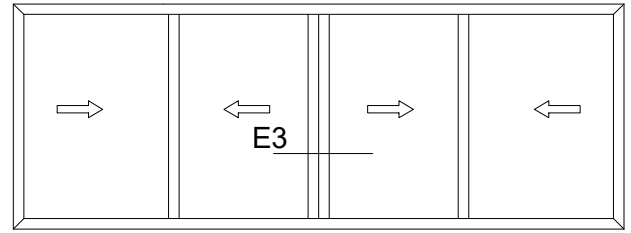

E3

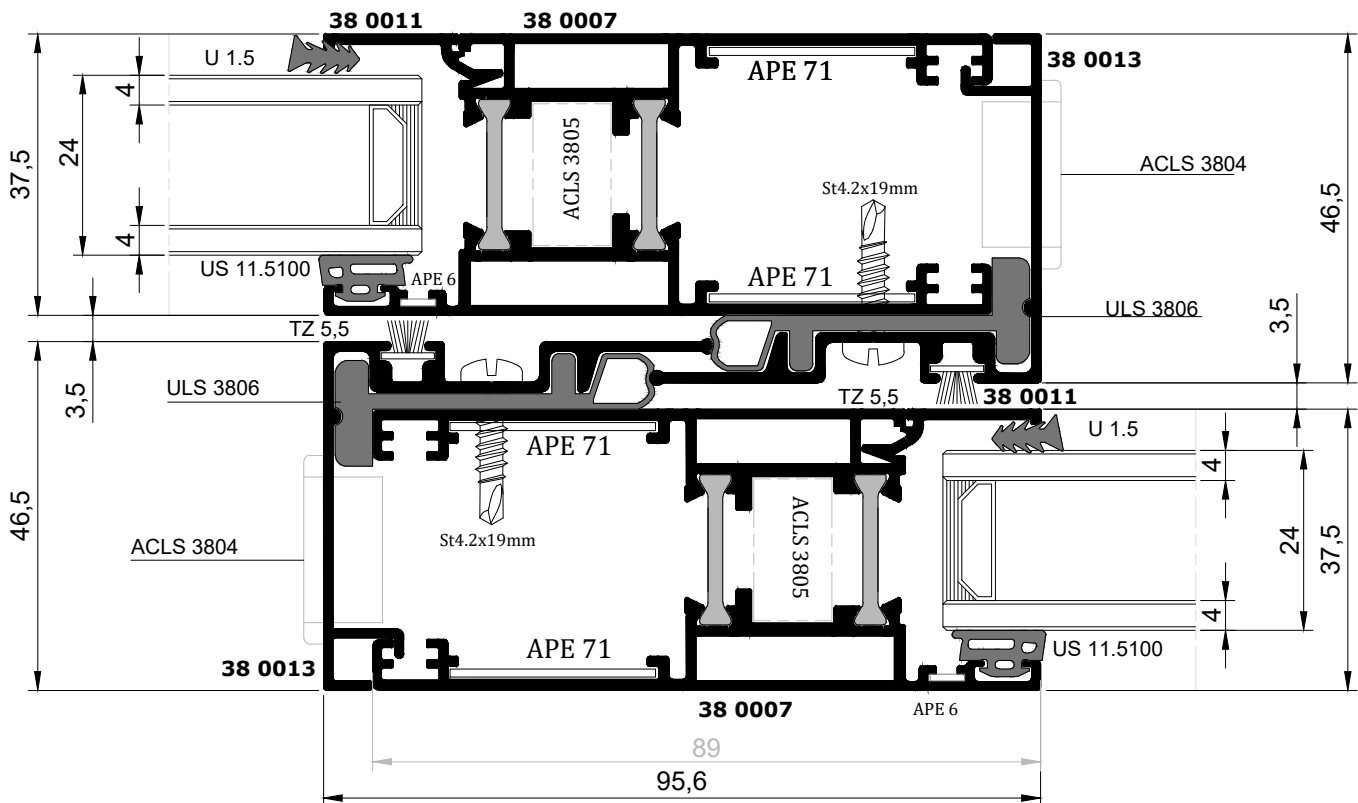
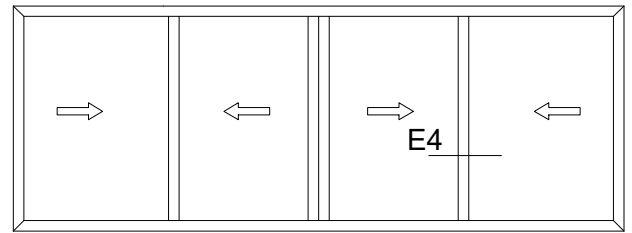

E4

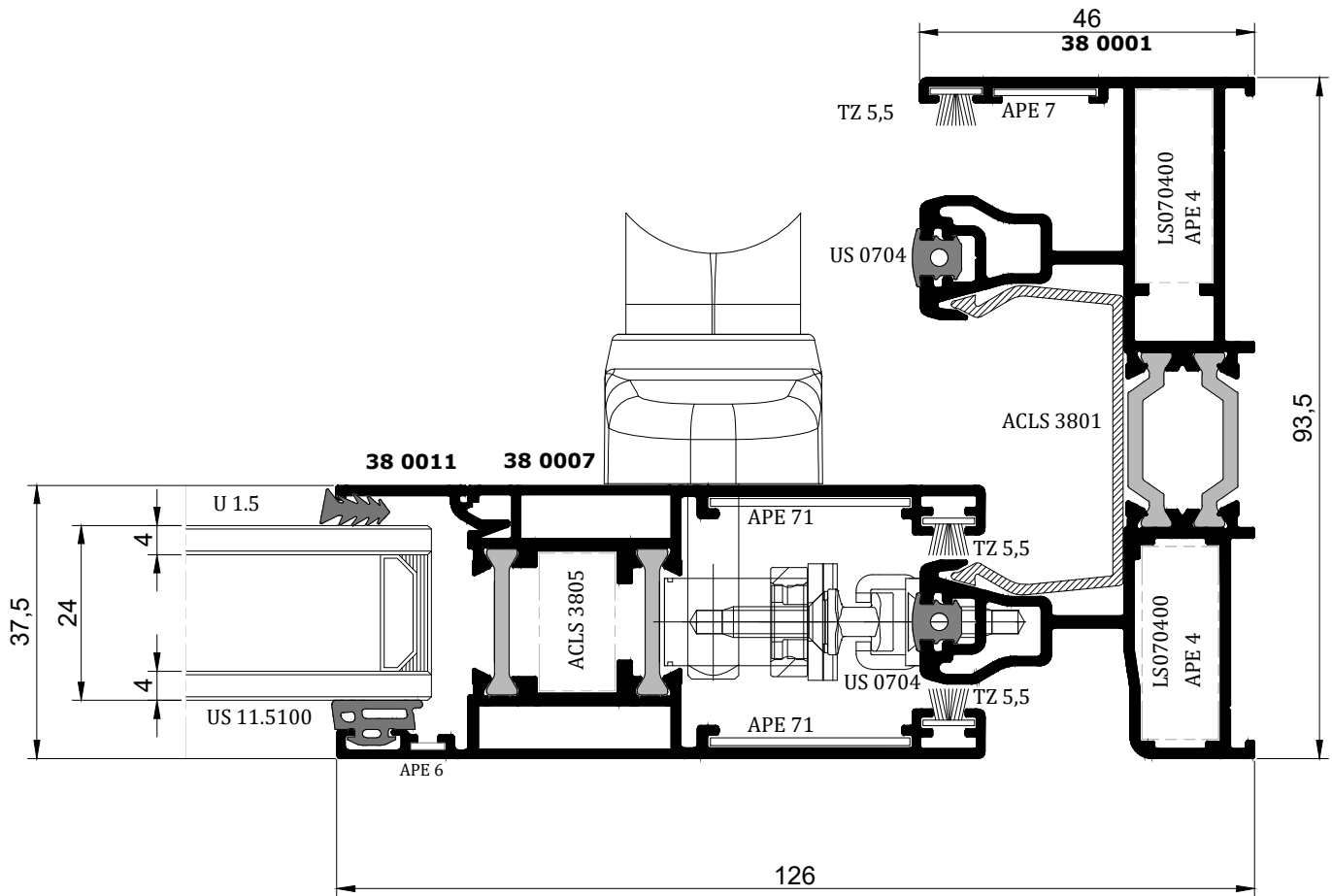
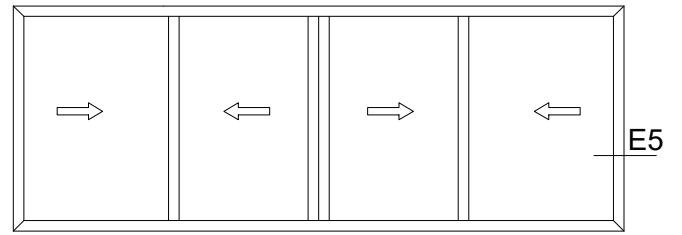

E5

SCALE 1:1

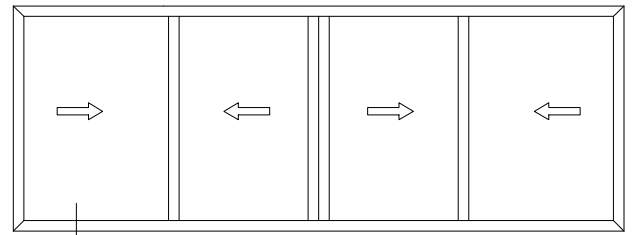

E6

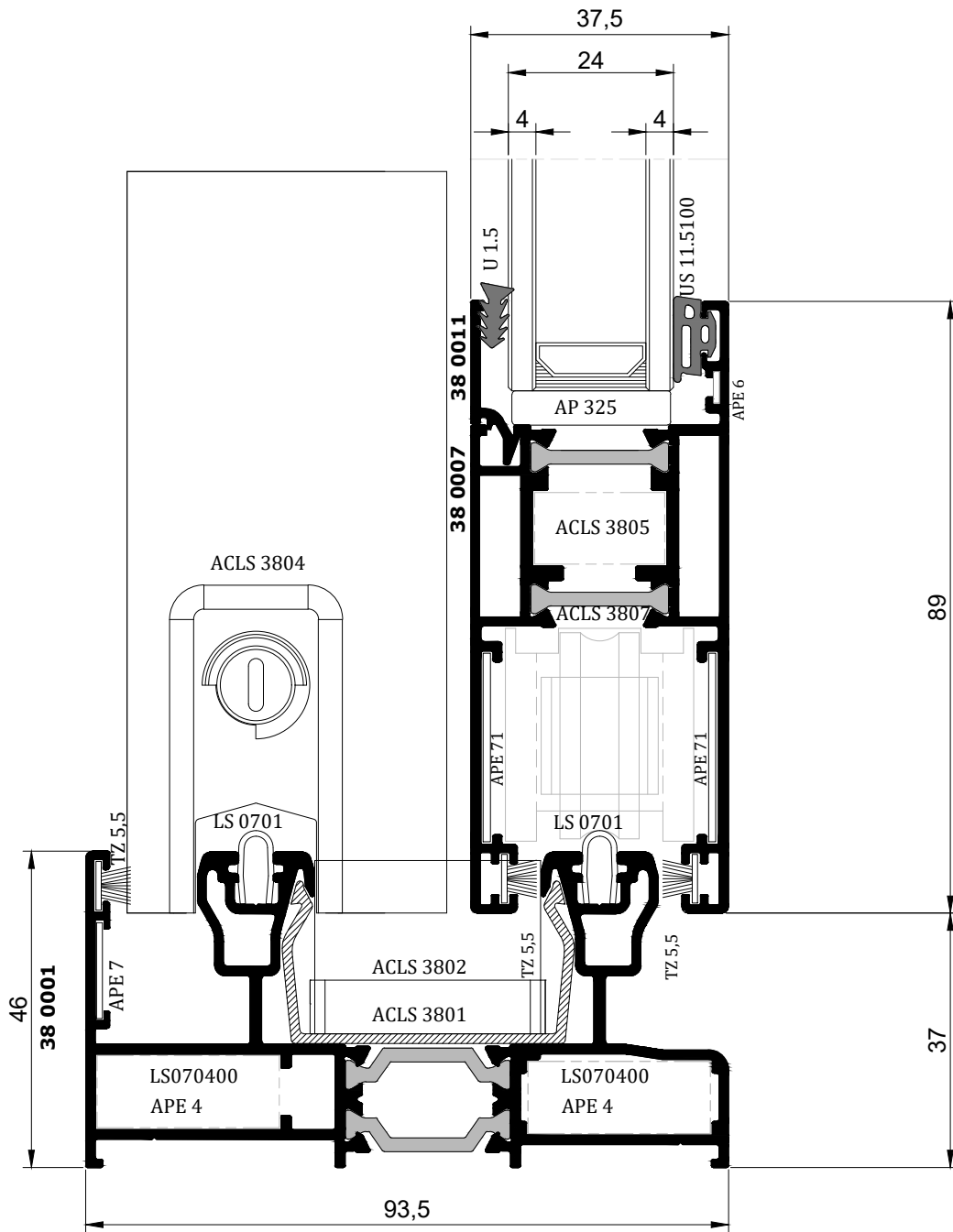

E6

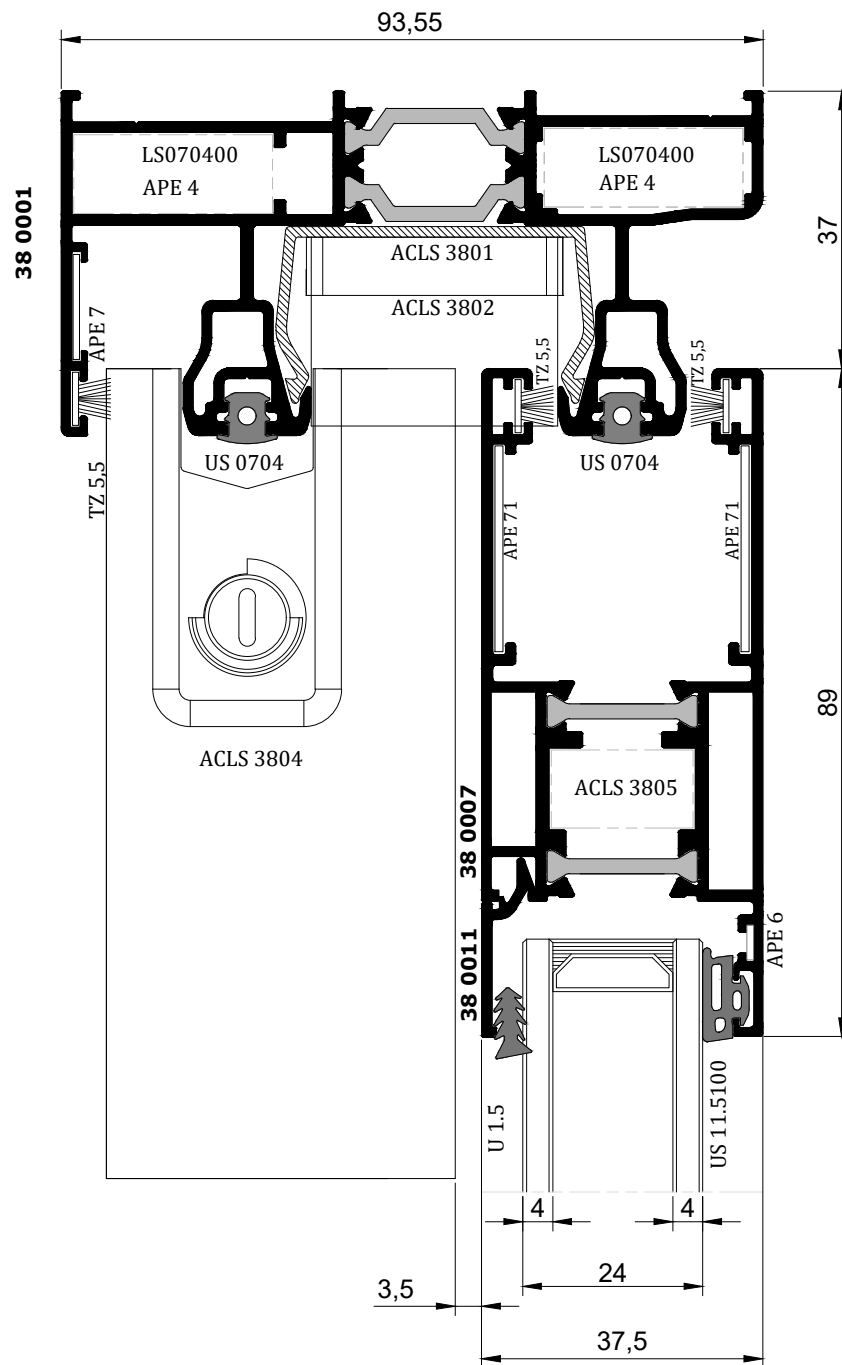
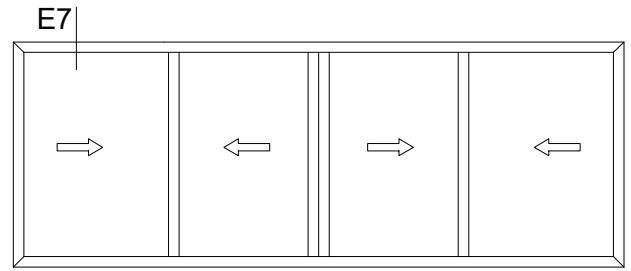

E7

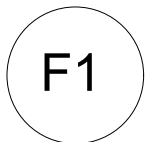
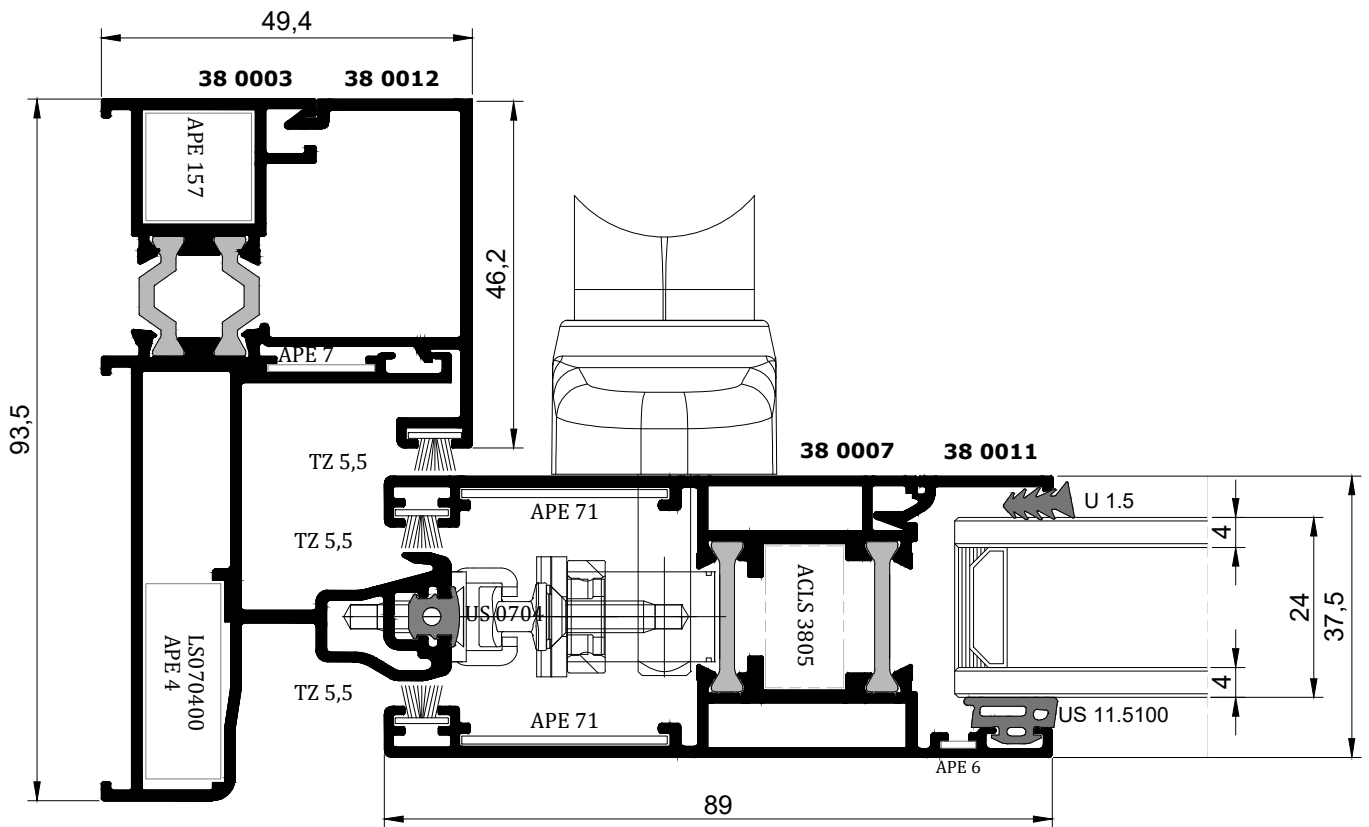
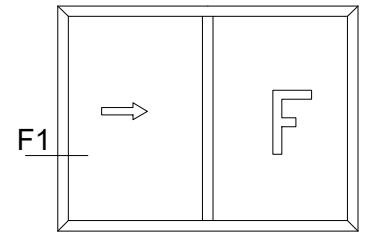

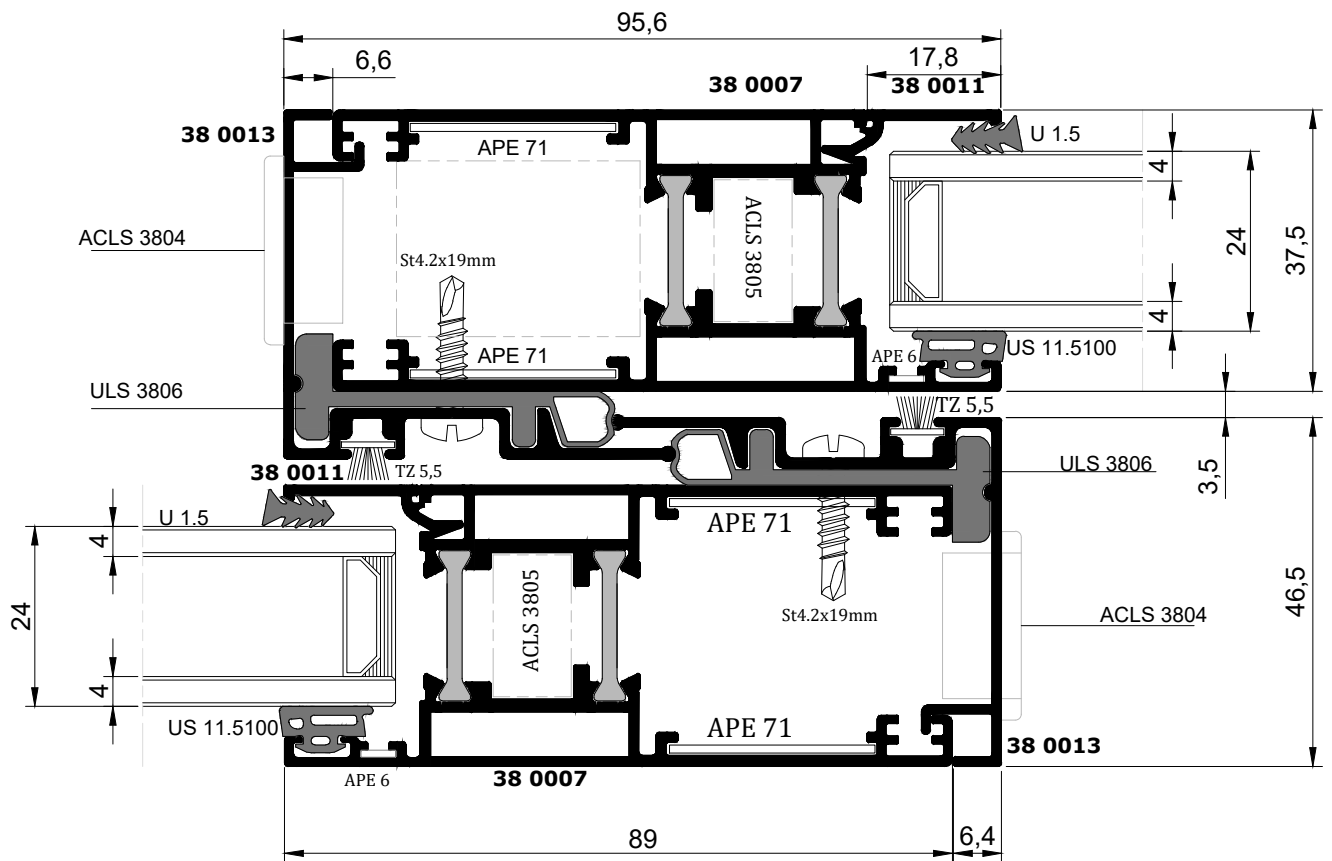
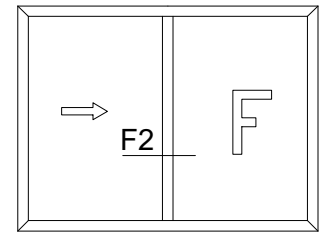

SCALE 1:1

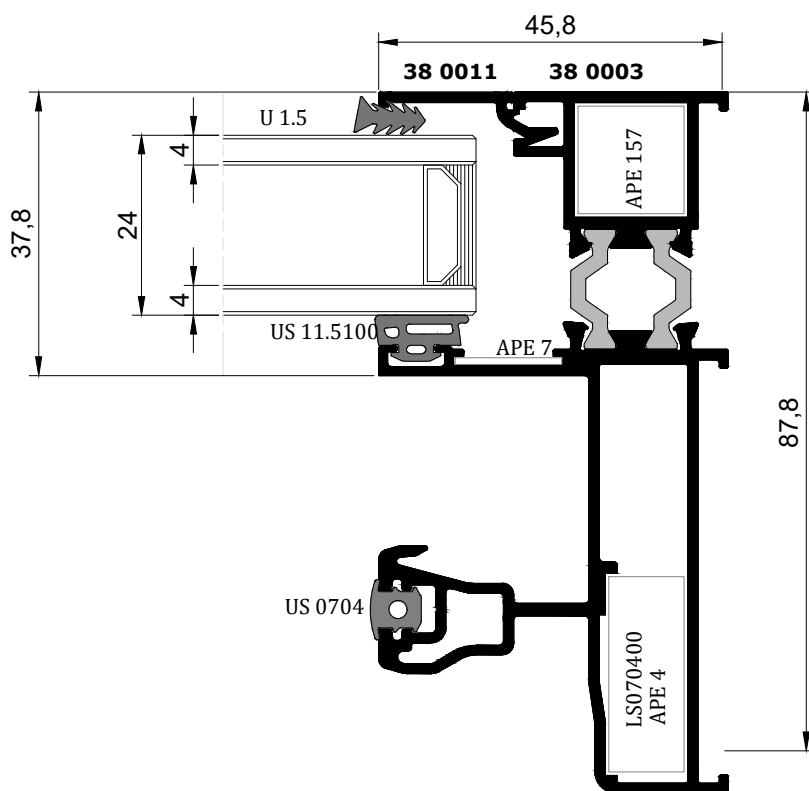
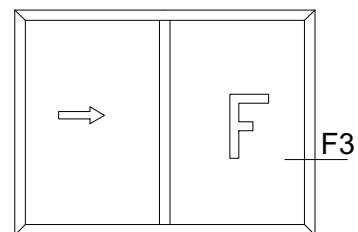

F3

SCALE 1:1

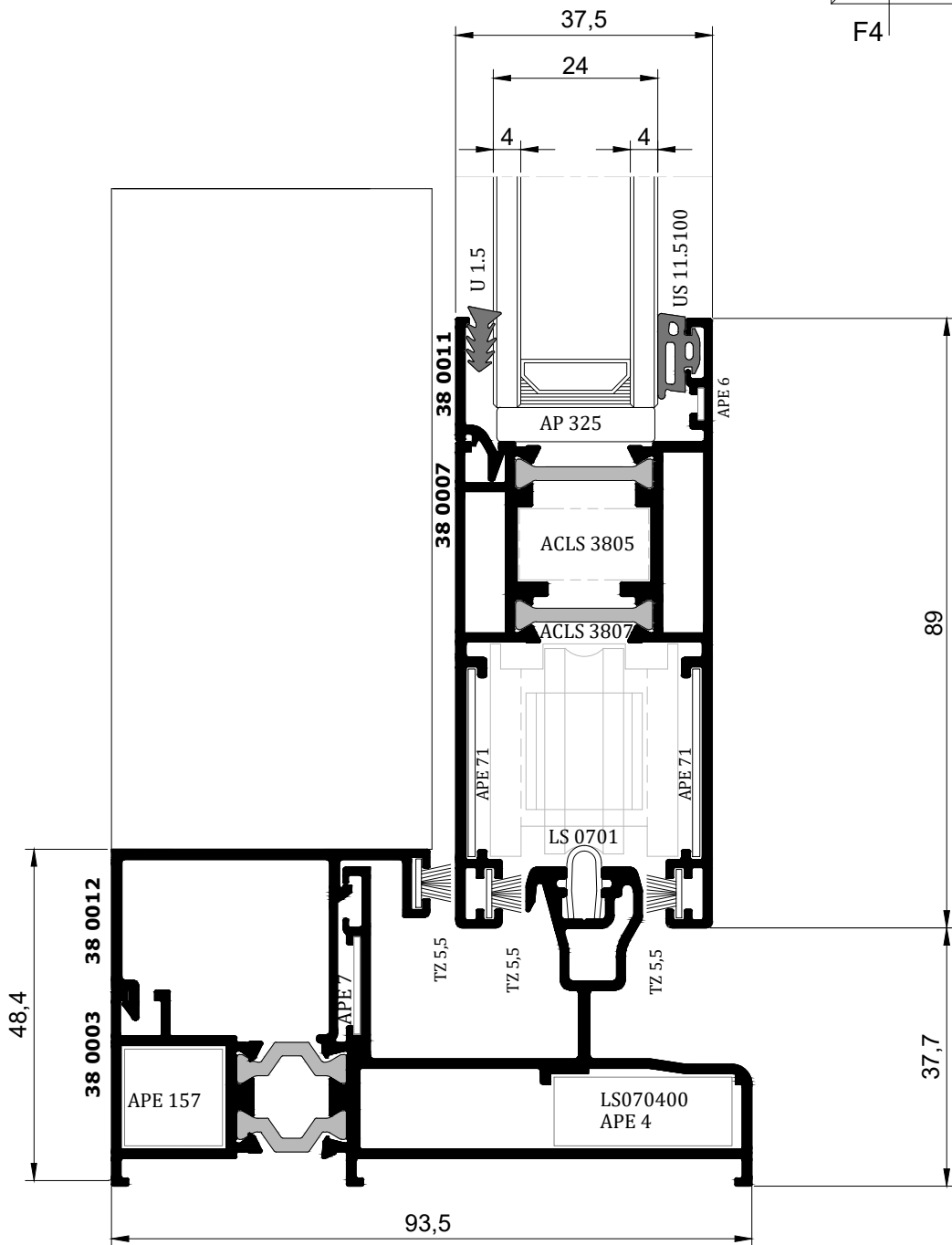

F4

SCALE 1:1

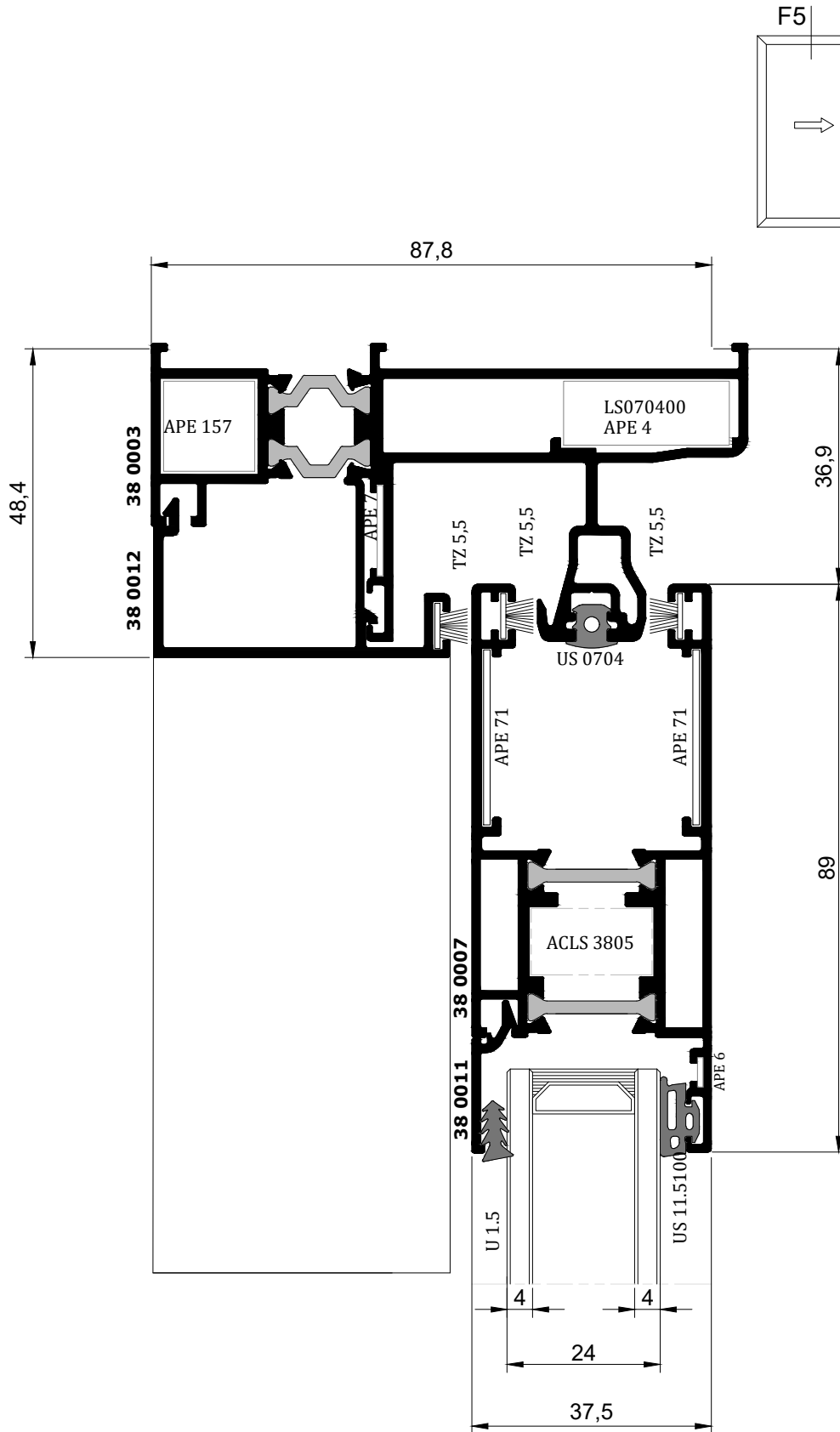

F5

SCALE 1:1

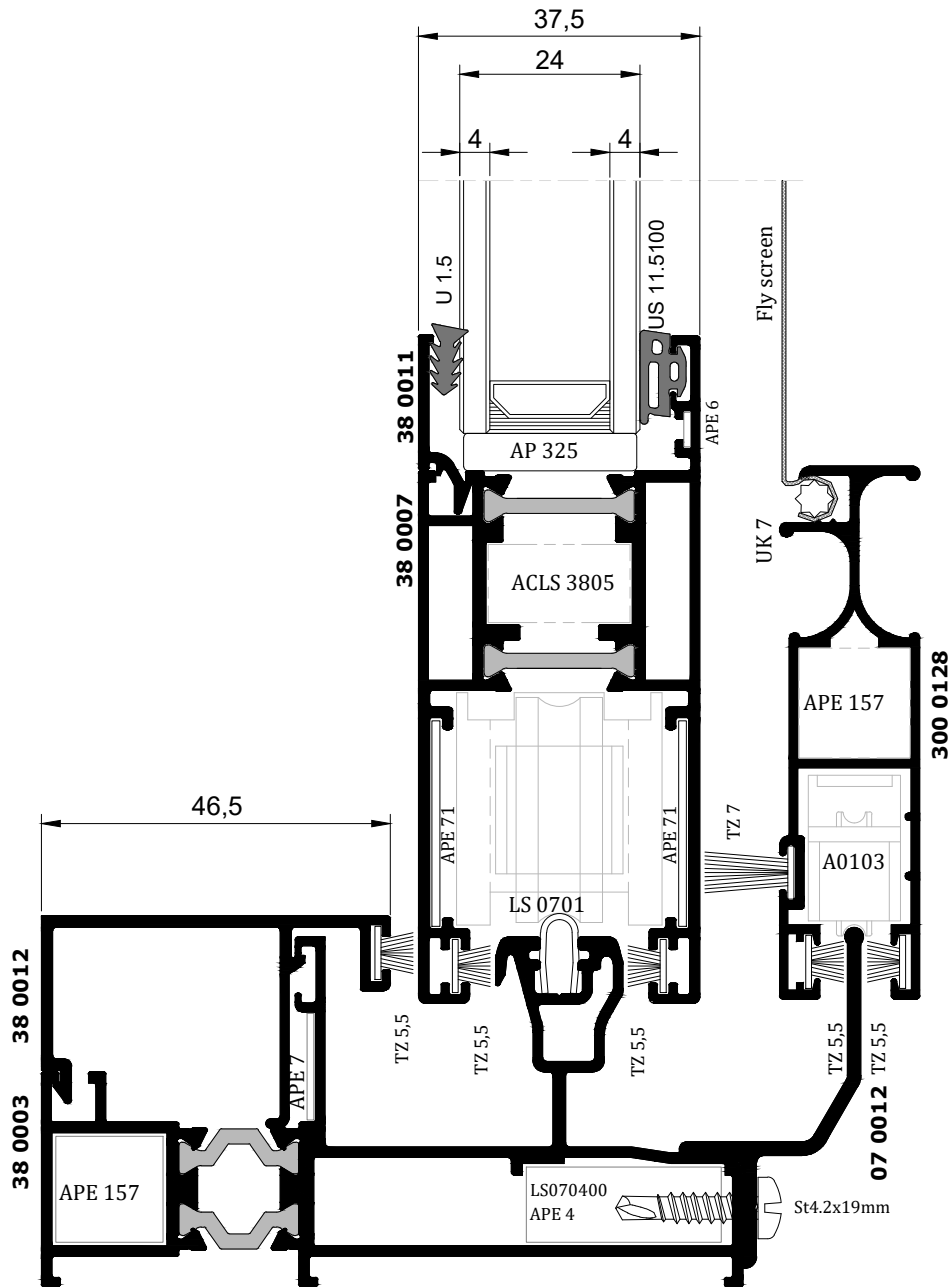
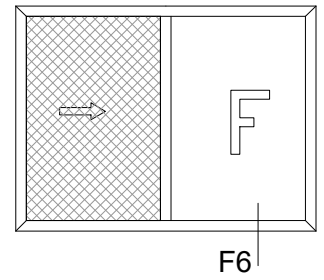

F6

SLIDE 38 SYSTEM

CUTTING LIST



TIPOLOGIES SLIDE 38 SYSTEM

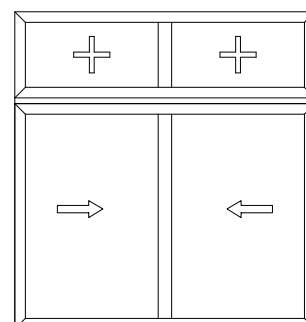
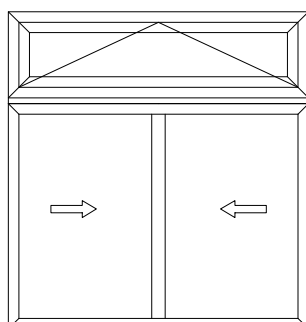
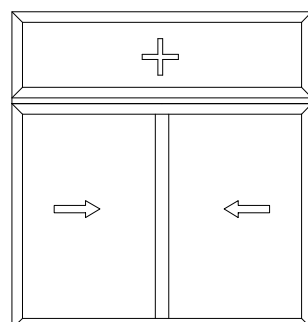
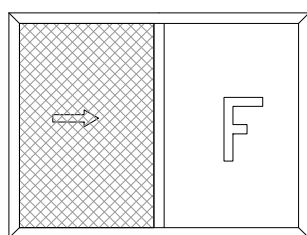
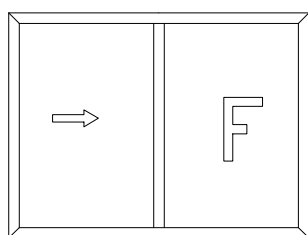
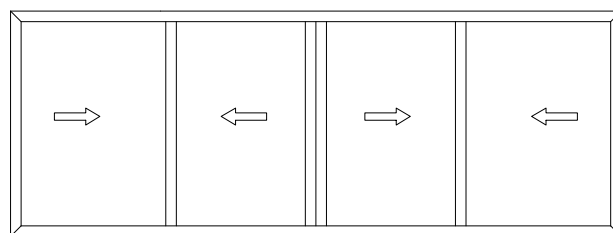
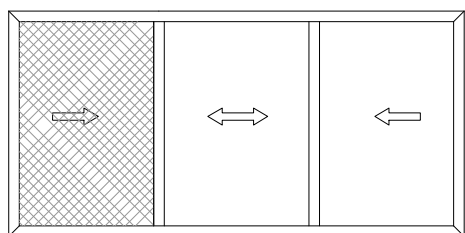
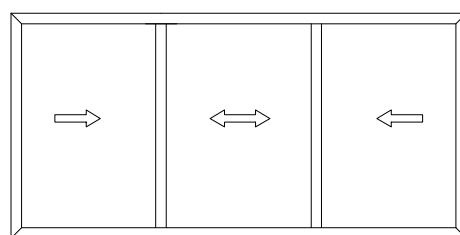
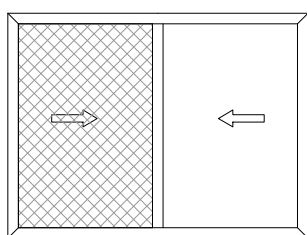
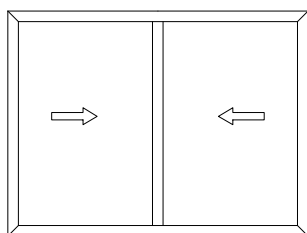

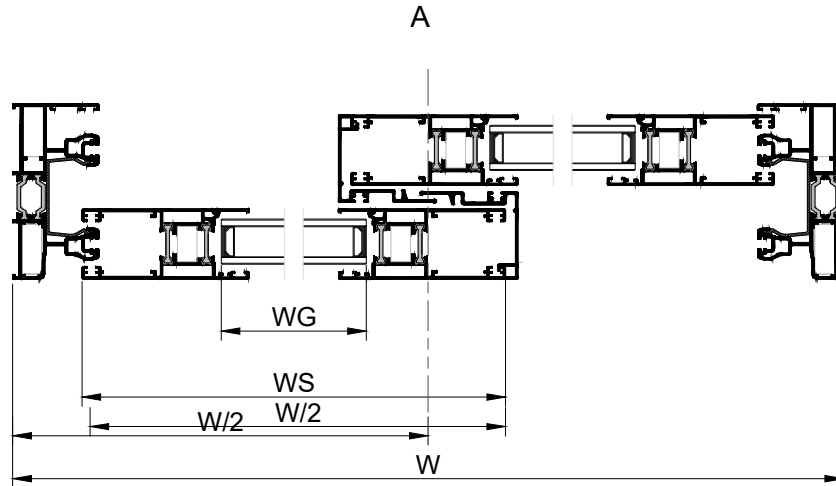
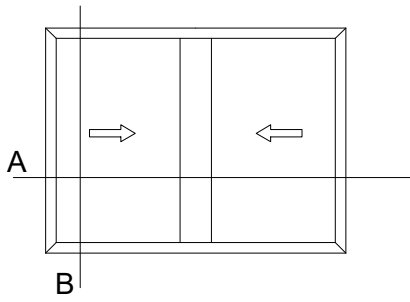

B

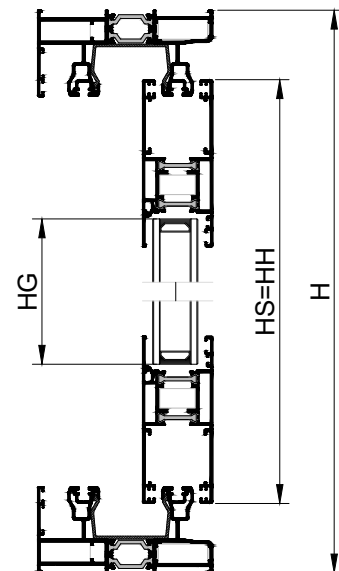

PROFILE CUTTING		
Description	Dimensions	Cut
Frame width	W	45°-45°
Frame height	H	45°-45°
Sash width	$WS = \frac{W + 8.55\text{mm}}{2}$	45°-45°
Sash height	$HS = H - 74\text{mm}$	45°-45°
Hook height	$HH = HS$	90°-90°
Glass width	$WG = WS - 148.4\text{mm}$	90°-90°
Glass height	$HG = HS - 148.4\text{mm}$	90°-90°

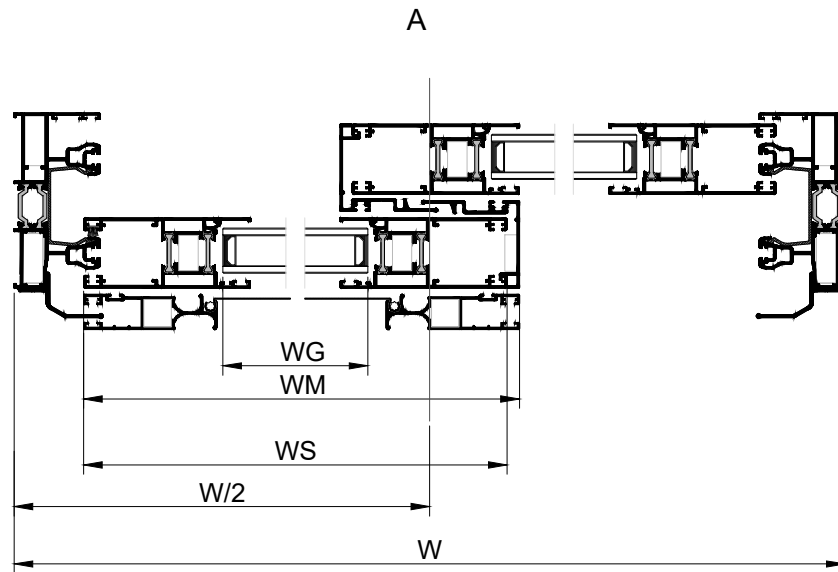
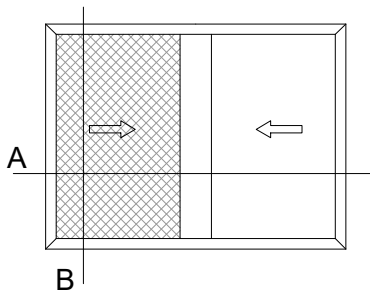

PROFILE CUTTING		
Description	Dimensions	Cut
Frame width	W	45°-45°
Frame height	H	45°-45°
Sash width	$WS = \frac{W + 8.55\text{mm}}{2}$	45°-45°
Sash height	$HS = H - 74\text{mm}$	45°-45°
Hook height	$HH = HS$	90°-90°
Mosquito profile width	$WM = WS + 6.5\text{mm}$	45°-45°
Mosquito profile height	$HM = HS$	45°-45°
Glass width	$WG = WS - 148.4\text{mm}$	90°-90°
Glass height	$HG = HS - 148.4\text{mm}$	90°-90°

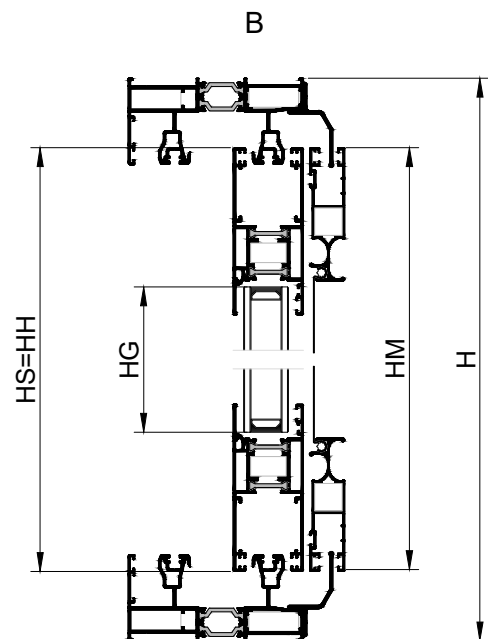

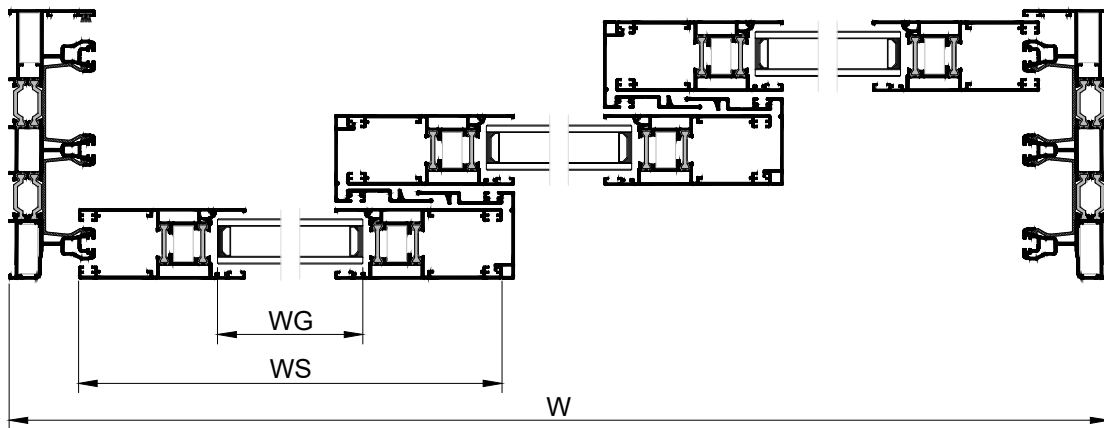
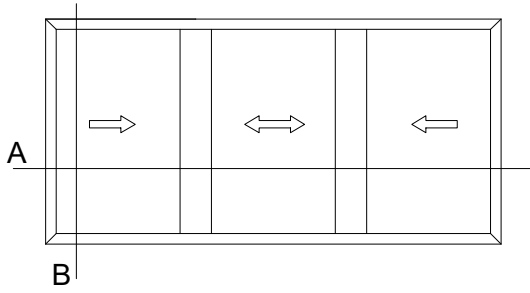

PROFILE CUTTING		
Description	Dimensions	Cut
Frame width	W	45°-45°
Frame height	H	45°-45°
Sash width	$WS = \frac{W + 90,8 \text{ mm}}{3}$	45°-45°
Sash height	$HS = H - 74 \text{ mm}$	45°-45°
Hook height	$HH = HS$	90°-90°
Glass width	$WG = WS - 148.4 \text{ mm}$	90°-90°
Glass height	$HG = HS - 148.4 \text{ mm}$	90°-90°

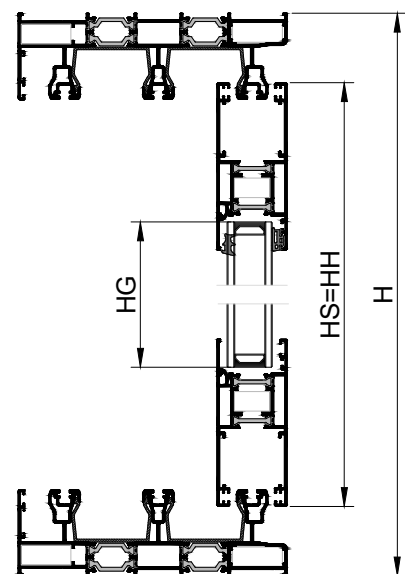

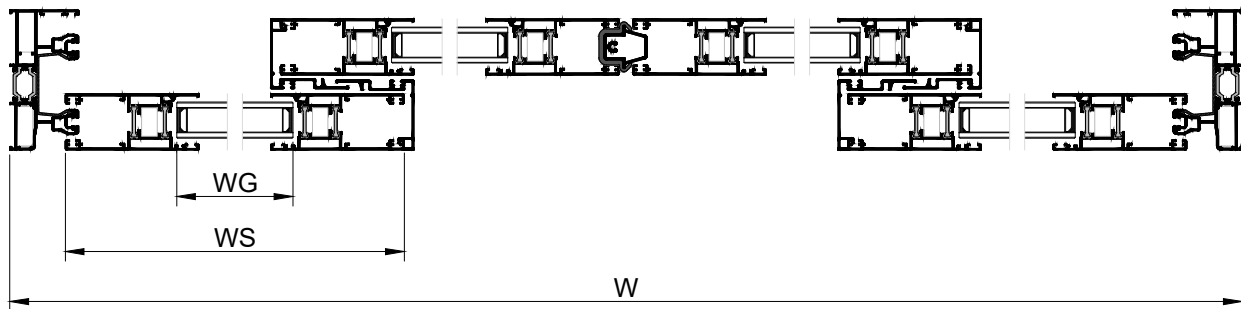
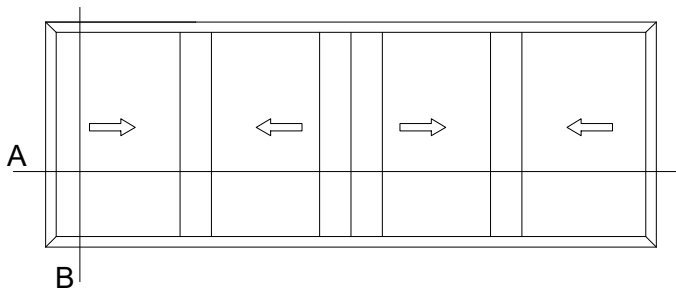

PROFILE CUTTING		
Description	Dimensions	
Frame width	W	45°-45°
Frame height	H	45°-45°
Sash width	$WS = \frac{W+82.1\text{mm}}{4}$	45°-45°
Sash height	$HS = H - 74\text{mm}$	45°-45°
Hook height	$HH = HS$	90°-90°
Meeting stile profile	$HME = HS - 70\text{mm}$	90°-90°
Glass width	$WG = WS - 148.4\text{mm}$	90°-90°
Glass height	$HG = HS - 148.4\text{mm}$	90°-90°

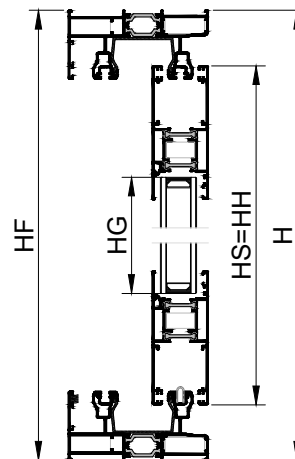

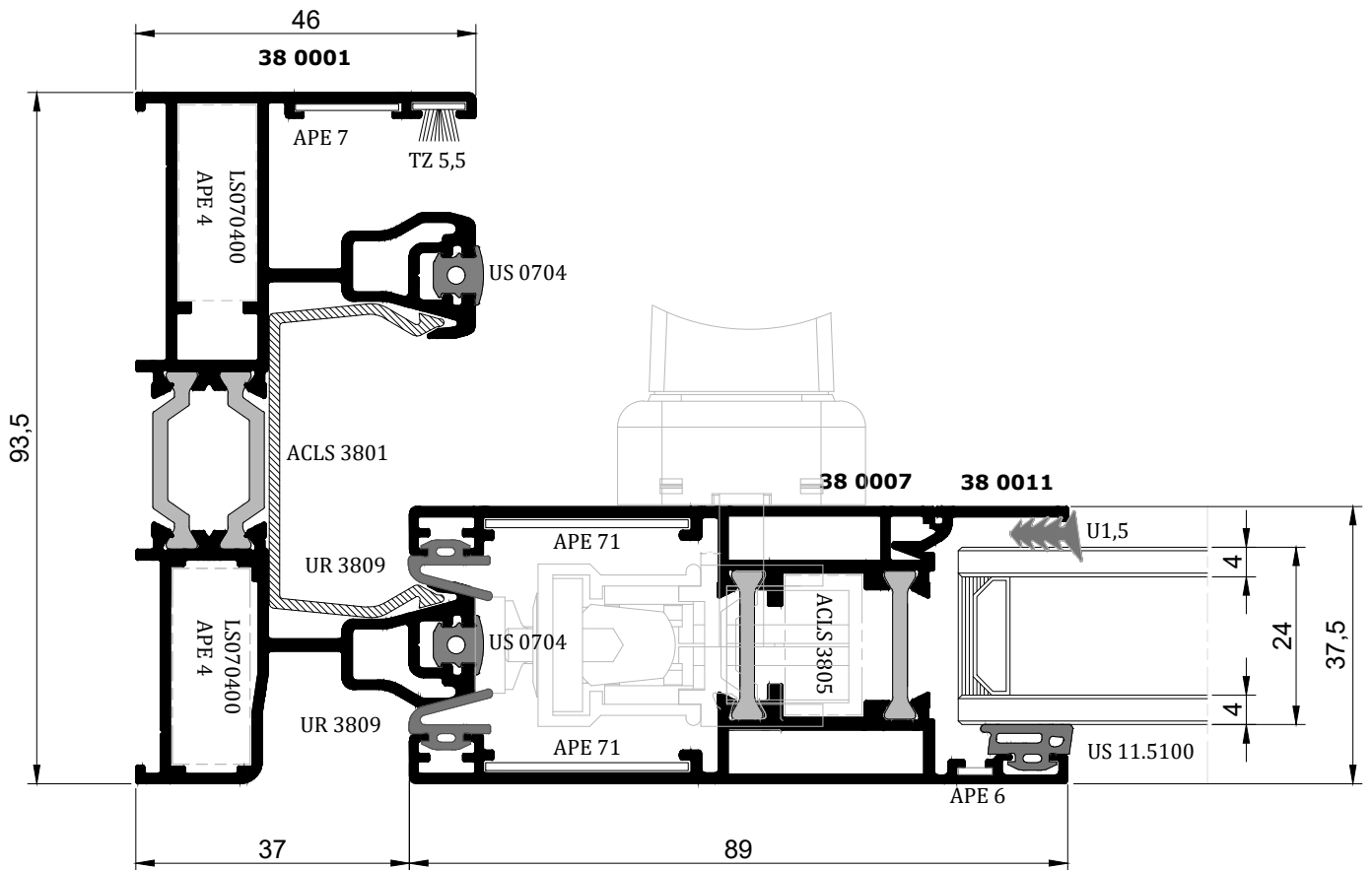
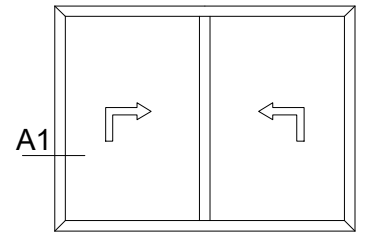

A1

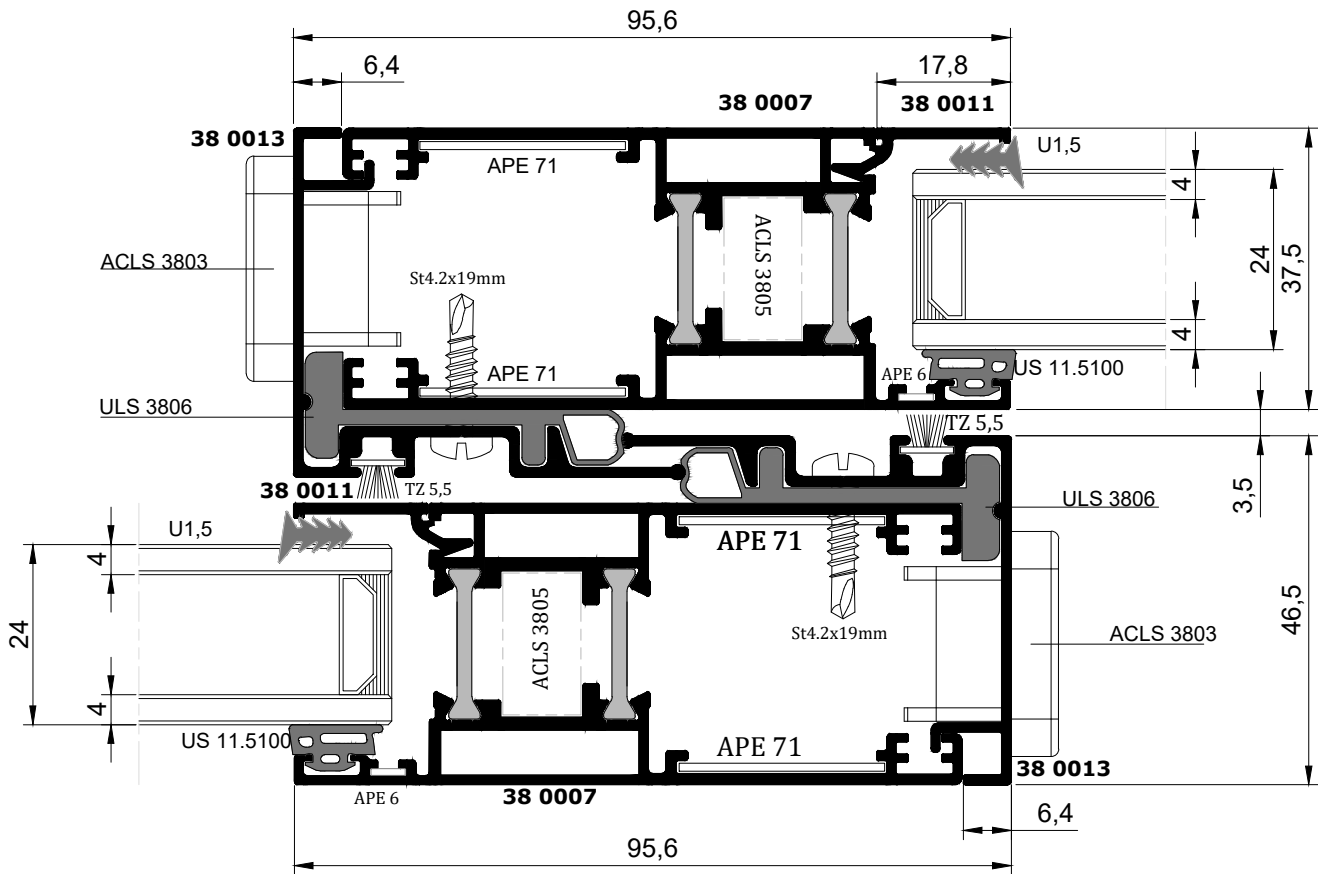
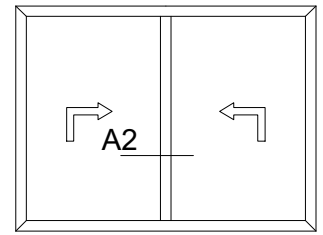

A2

SCALE 1:1

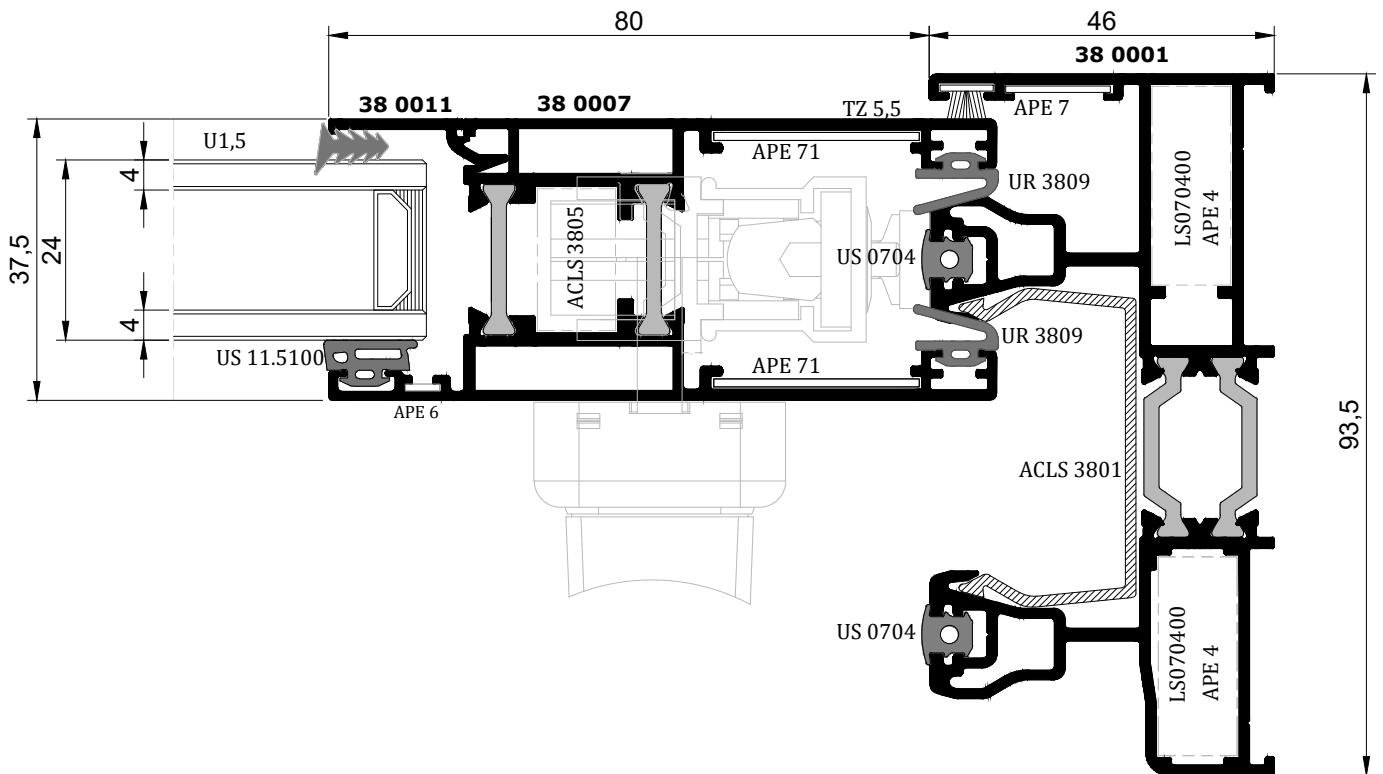
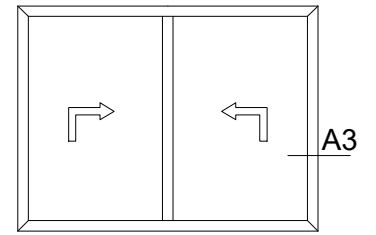

A3

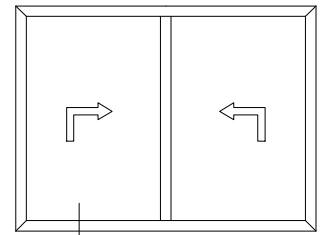

A4

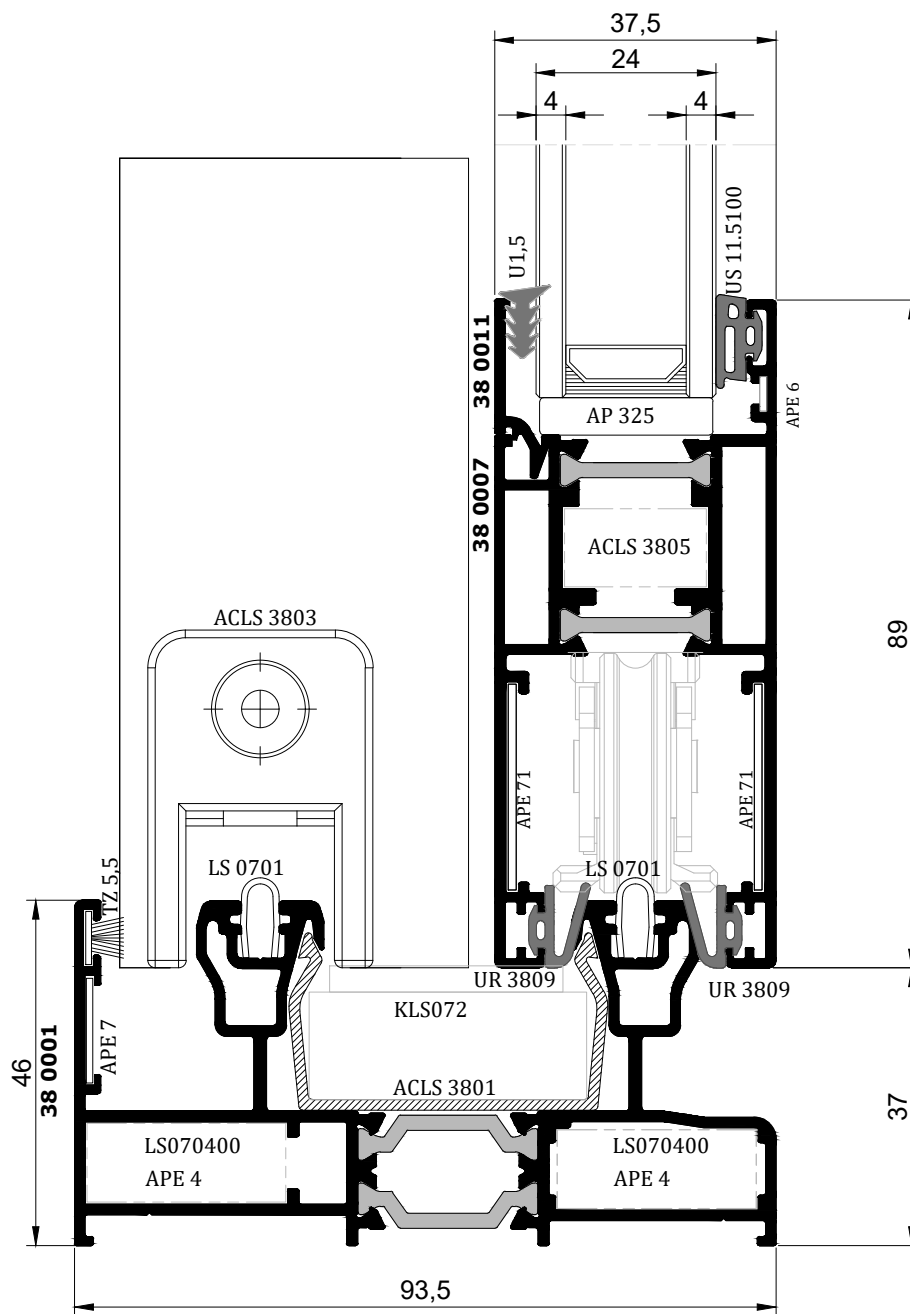

A4

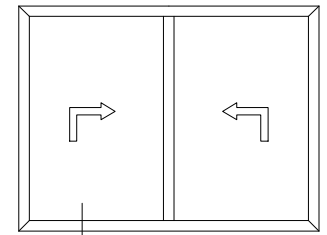

A4-a

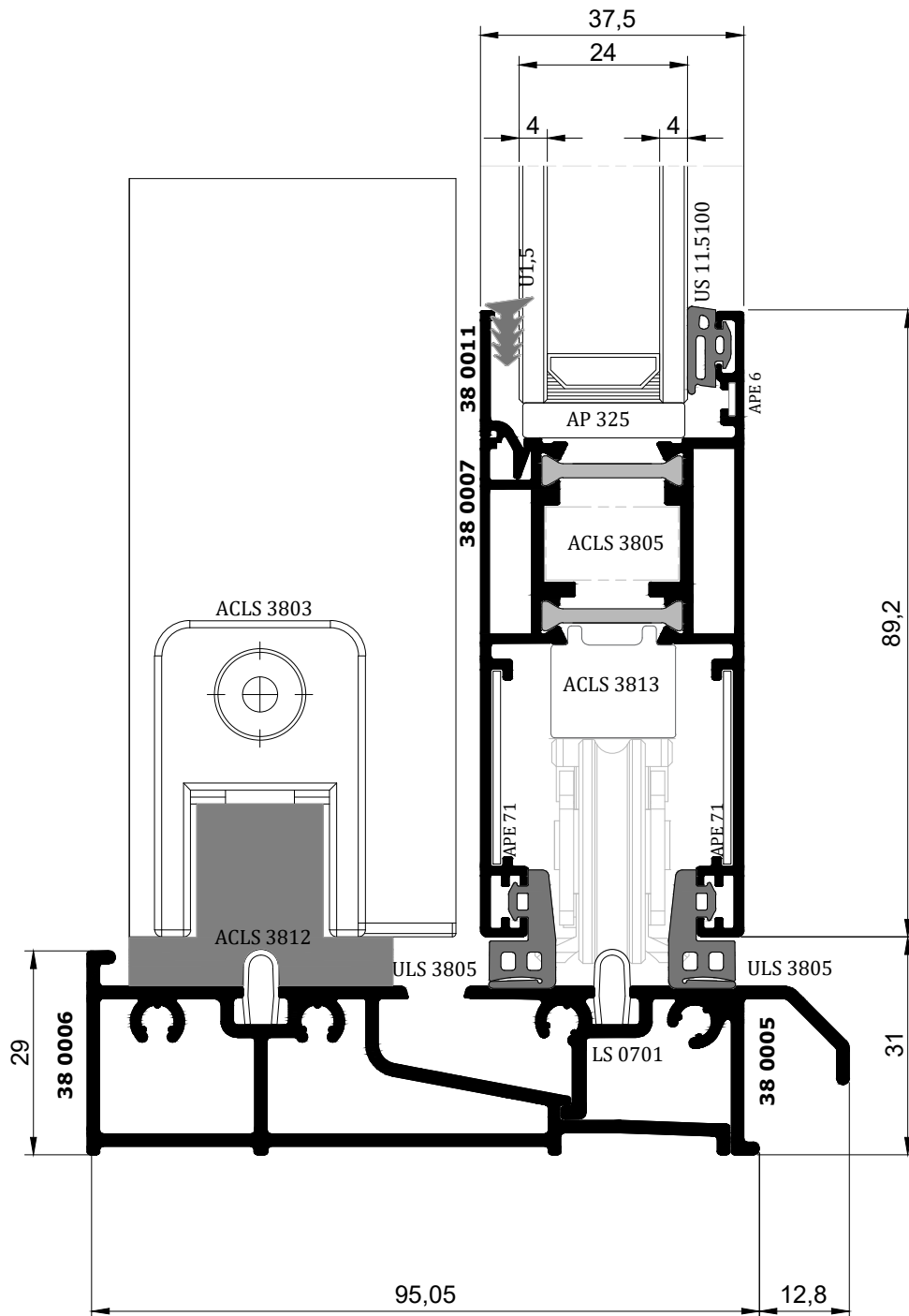

A4-a

Drainage profil

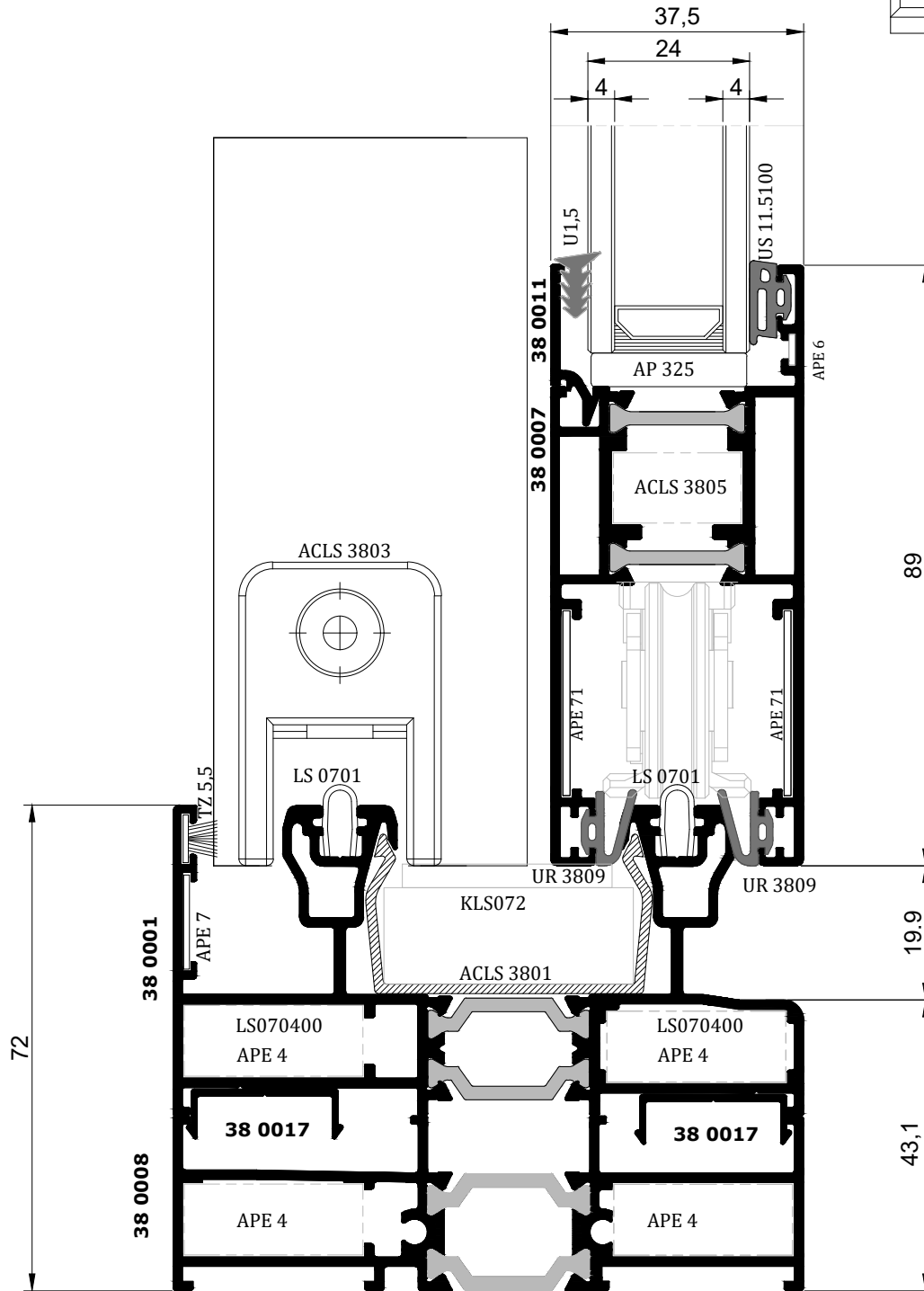
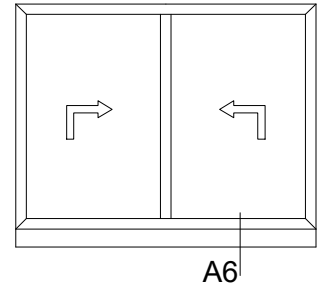

A6

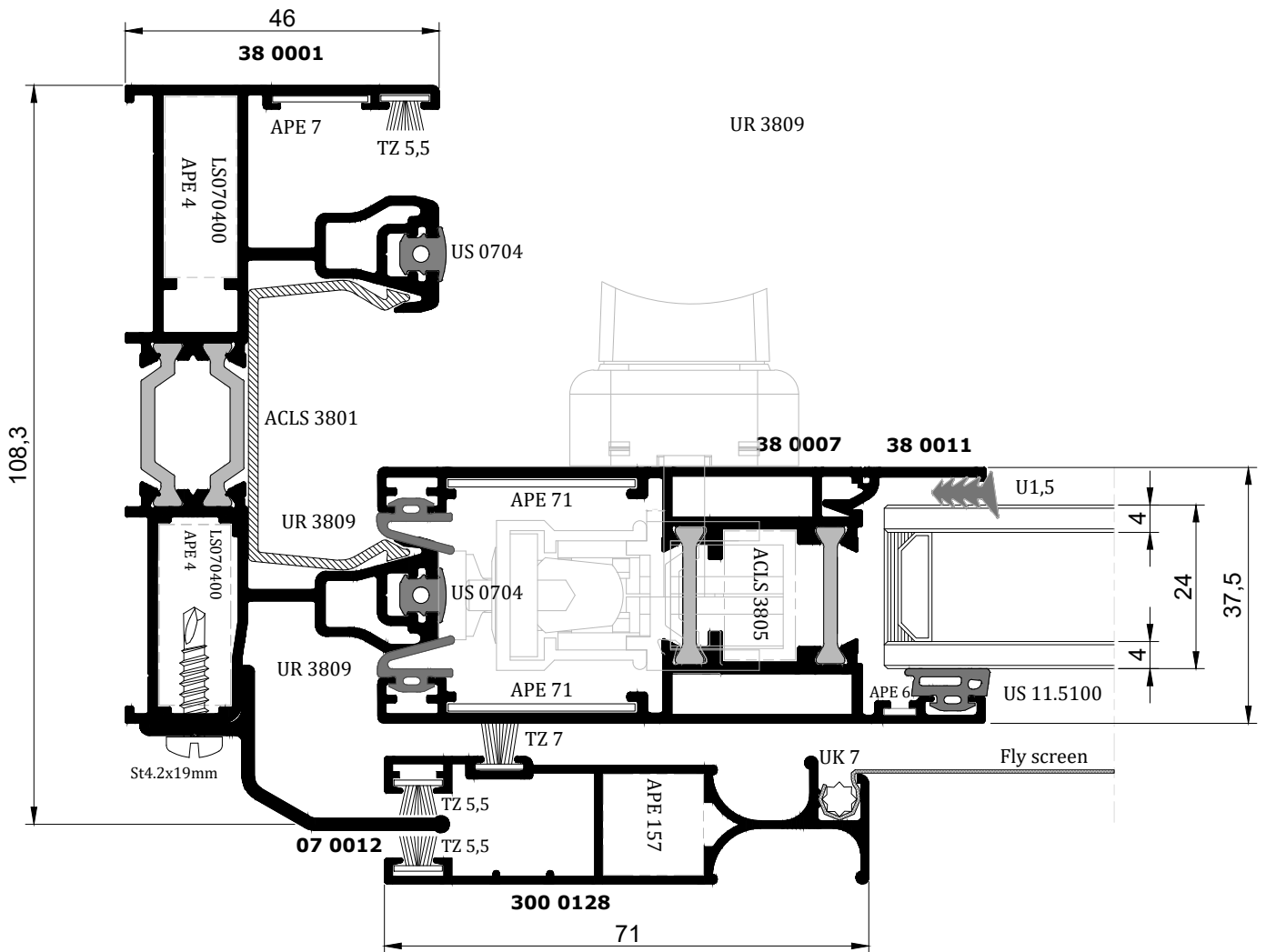
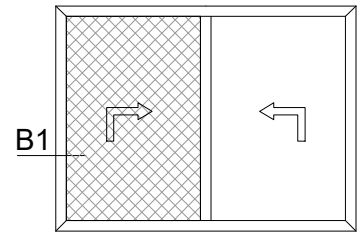

B1

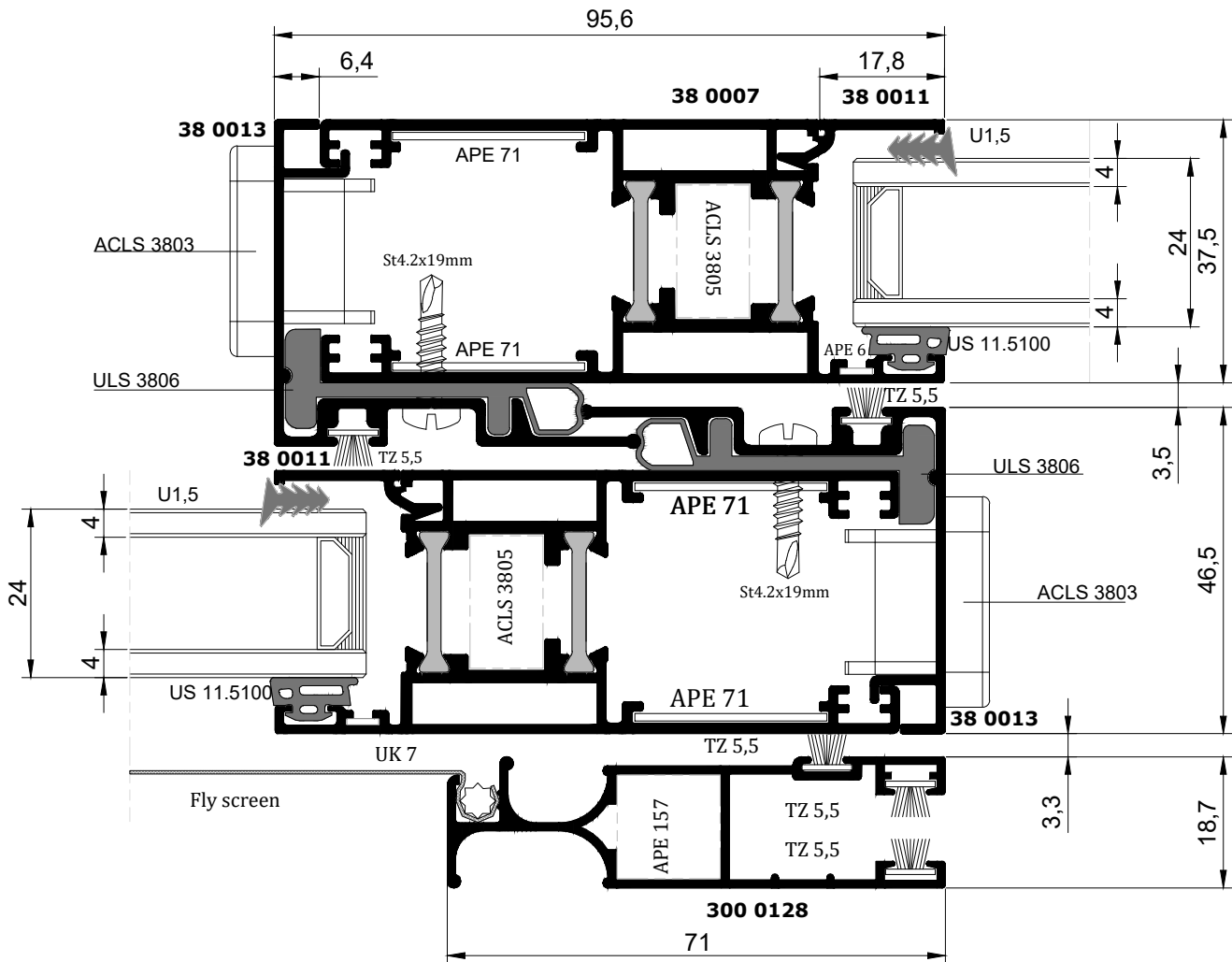
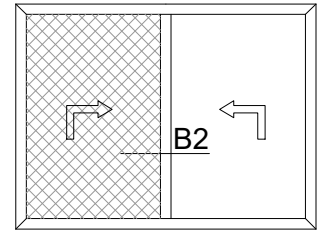

B2

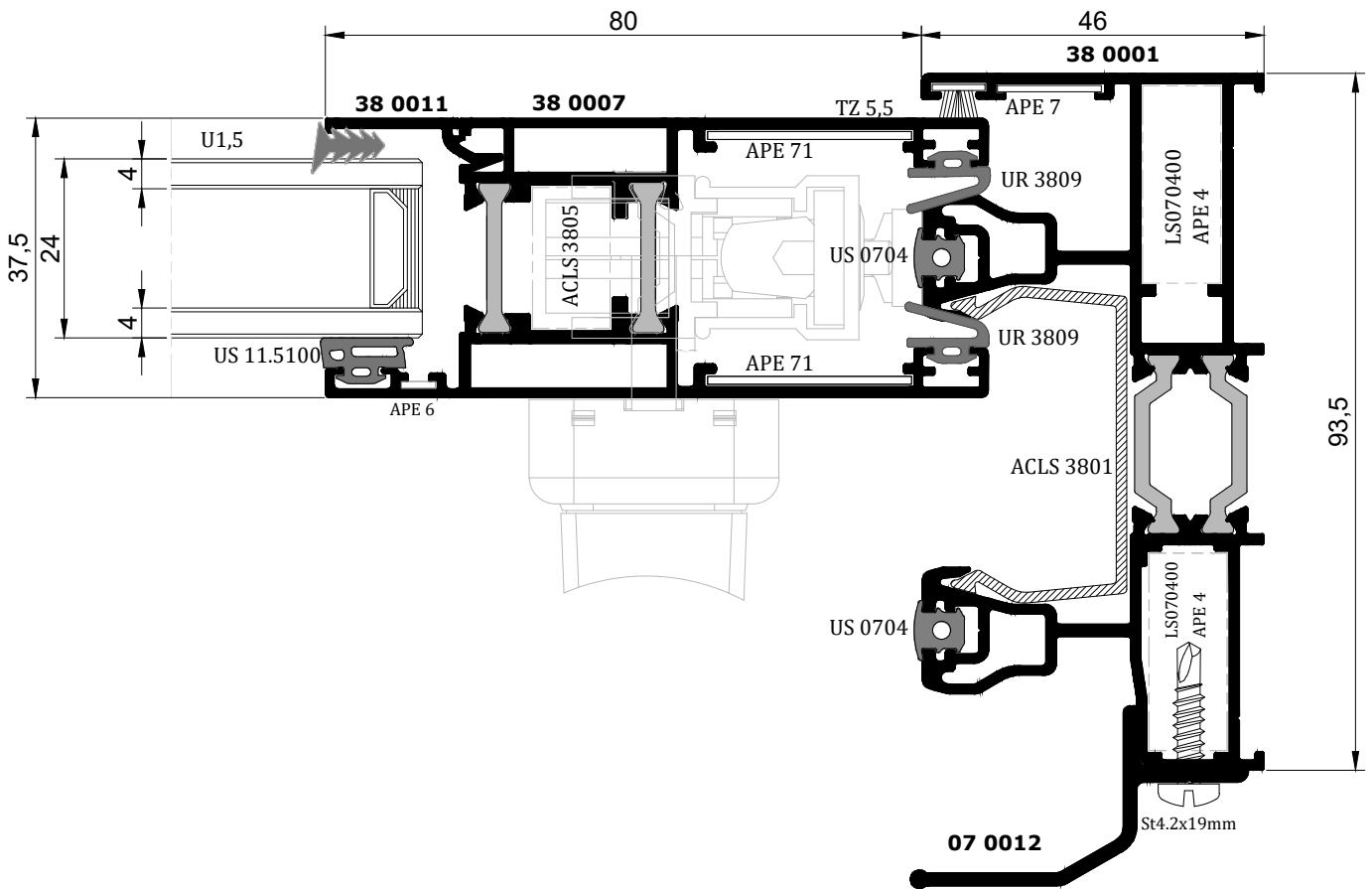
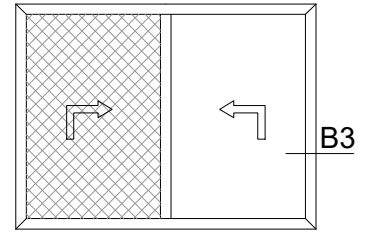

B3

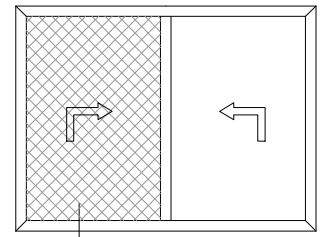

B4

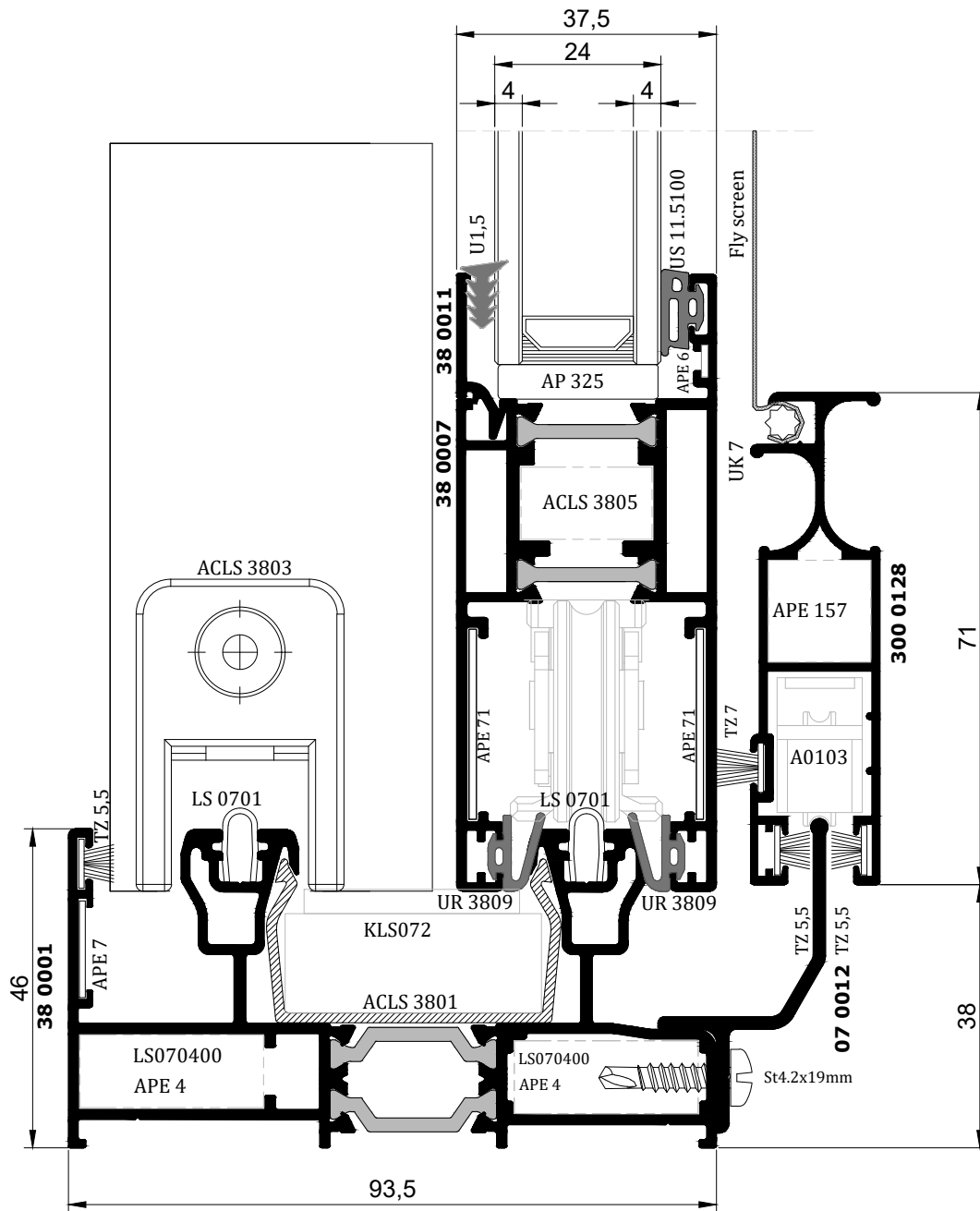

B4

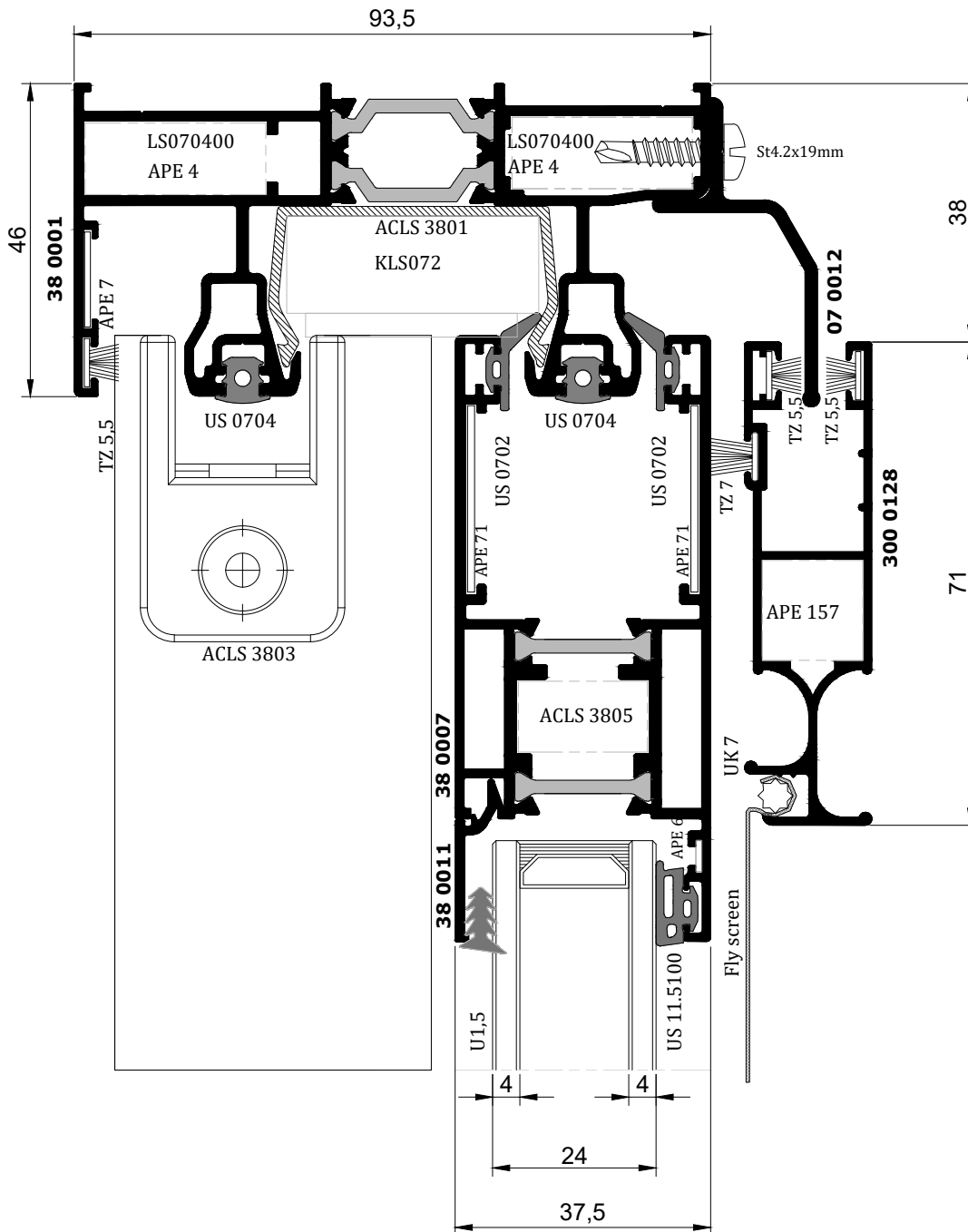
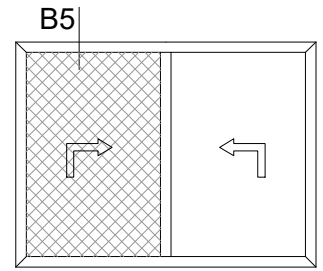

B5

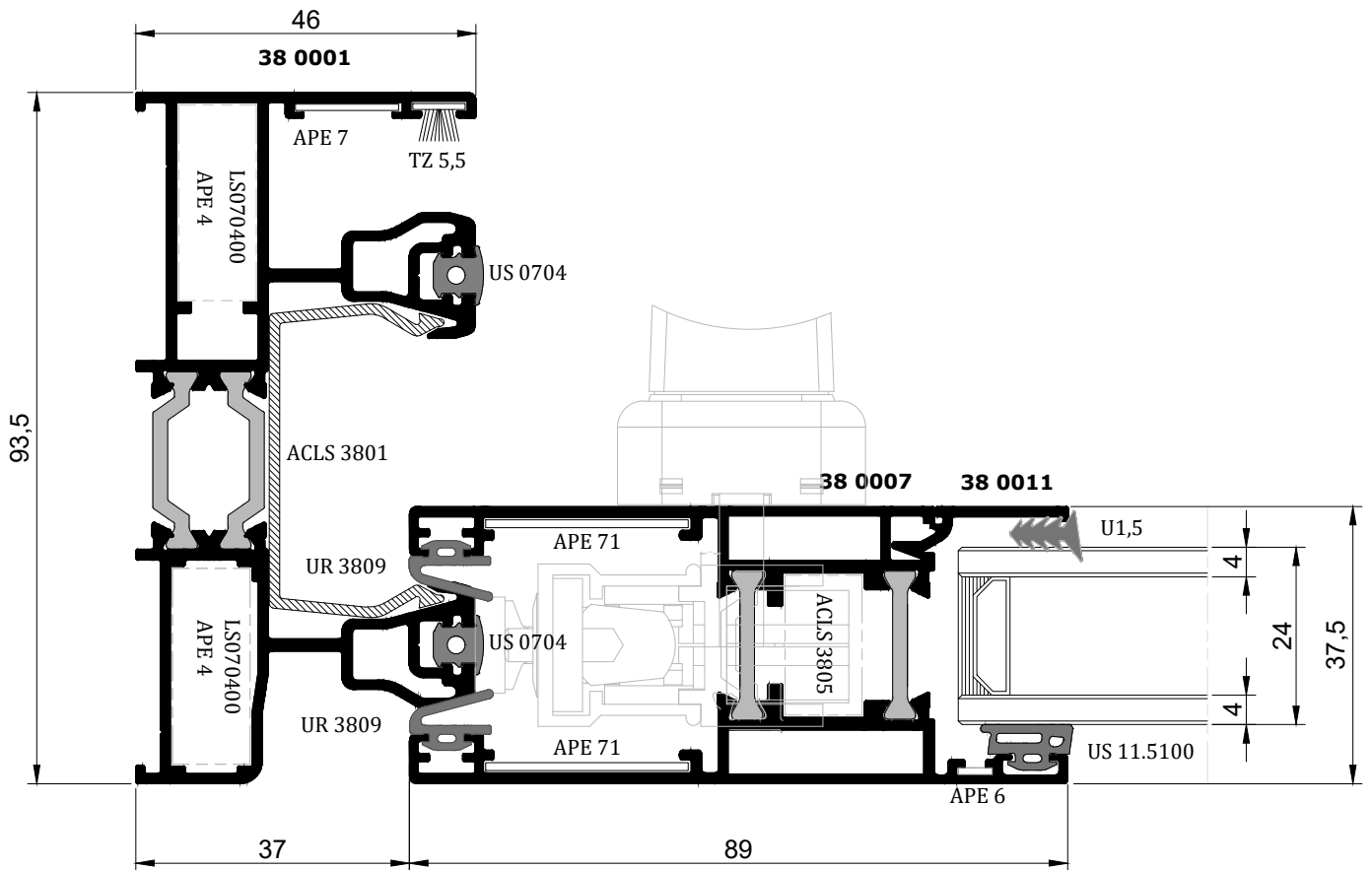
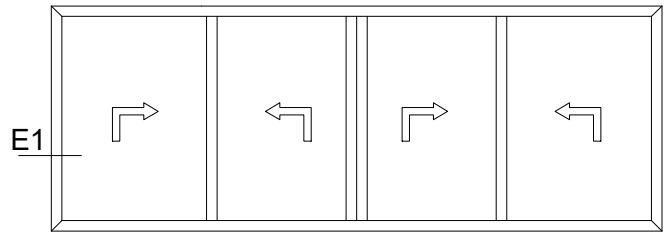

E1

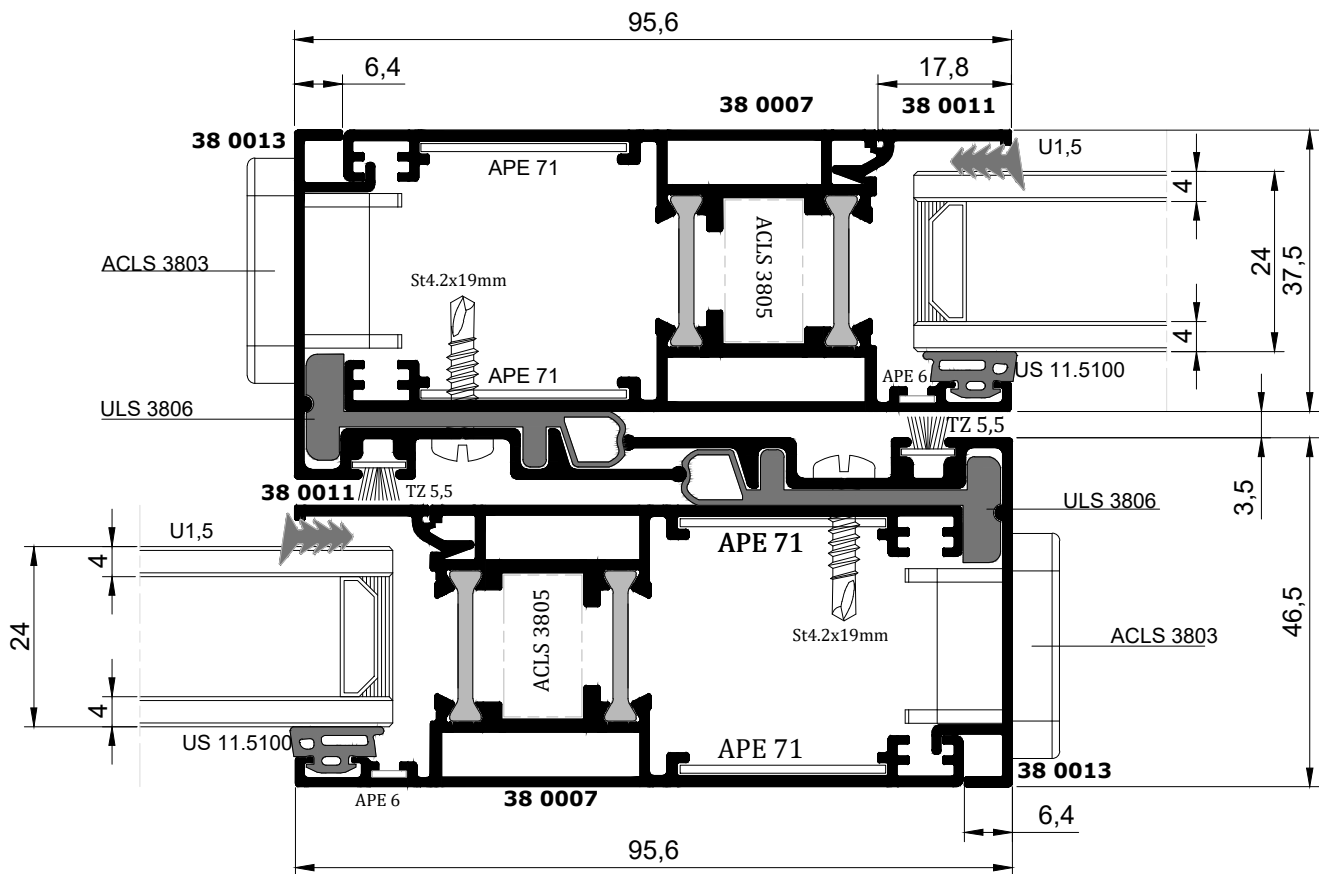
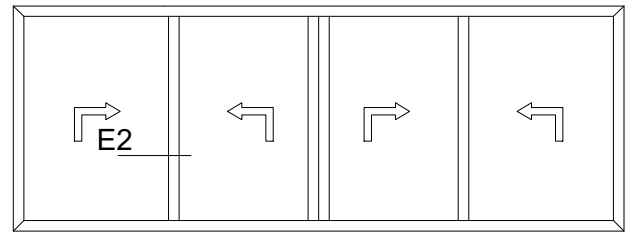

E2

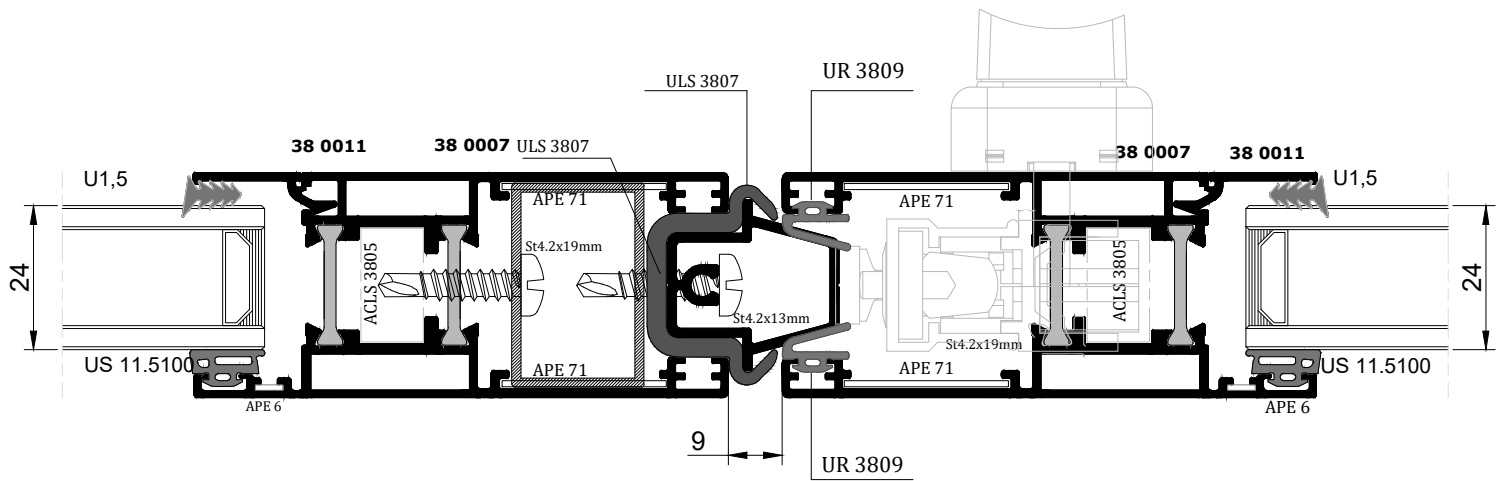
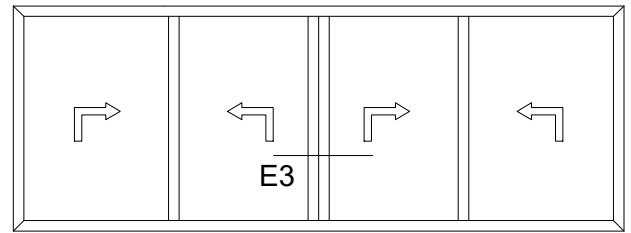

E3

Not in Scale

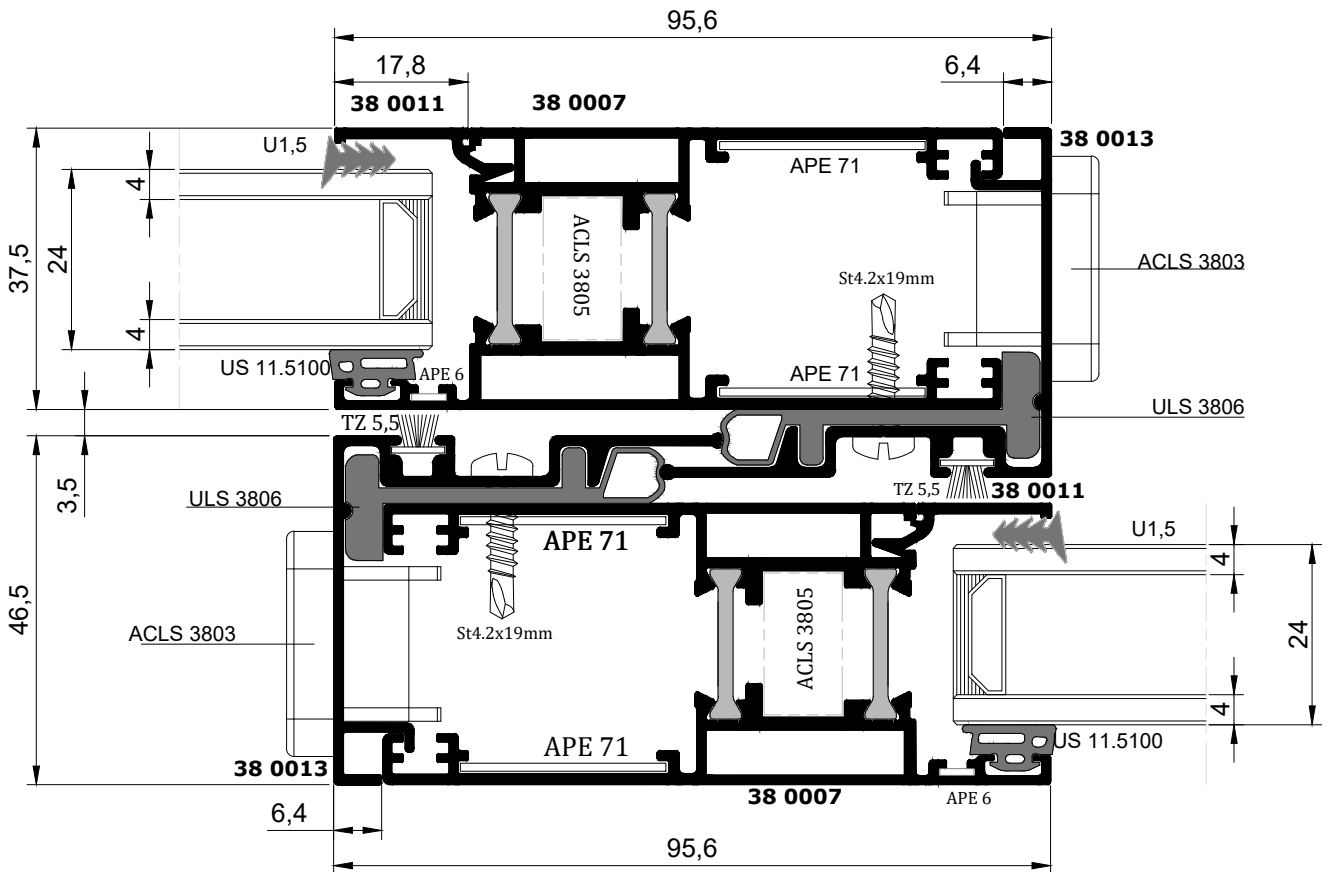
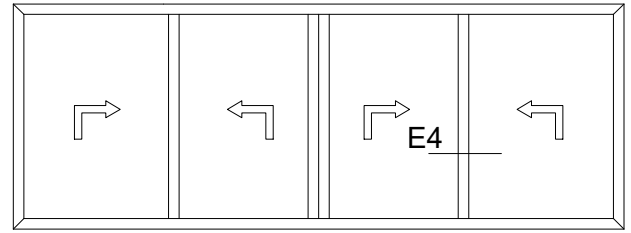

E4

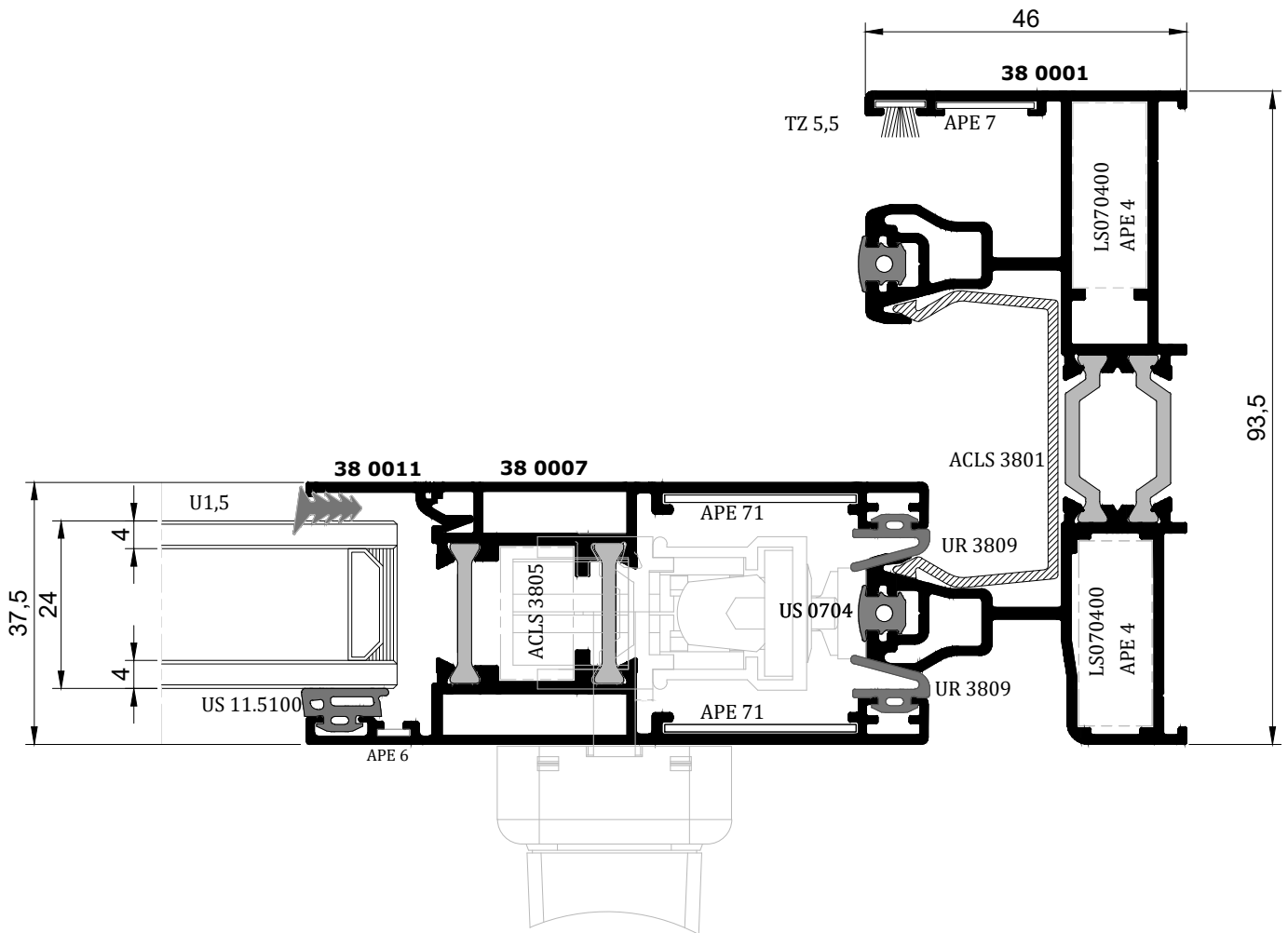
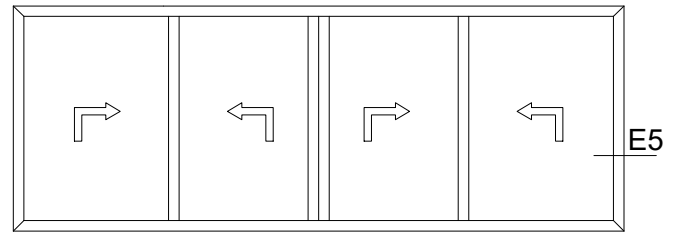

E5

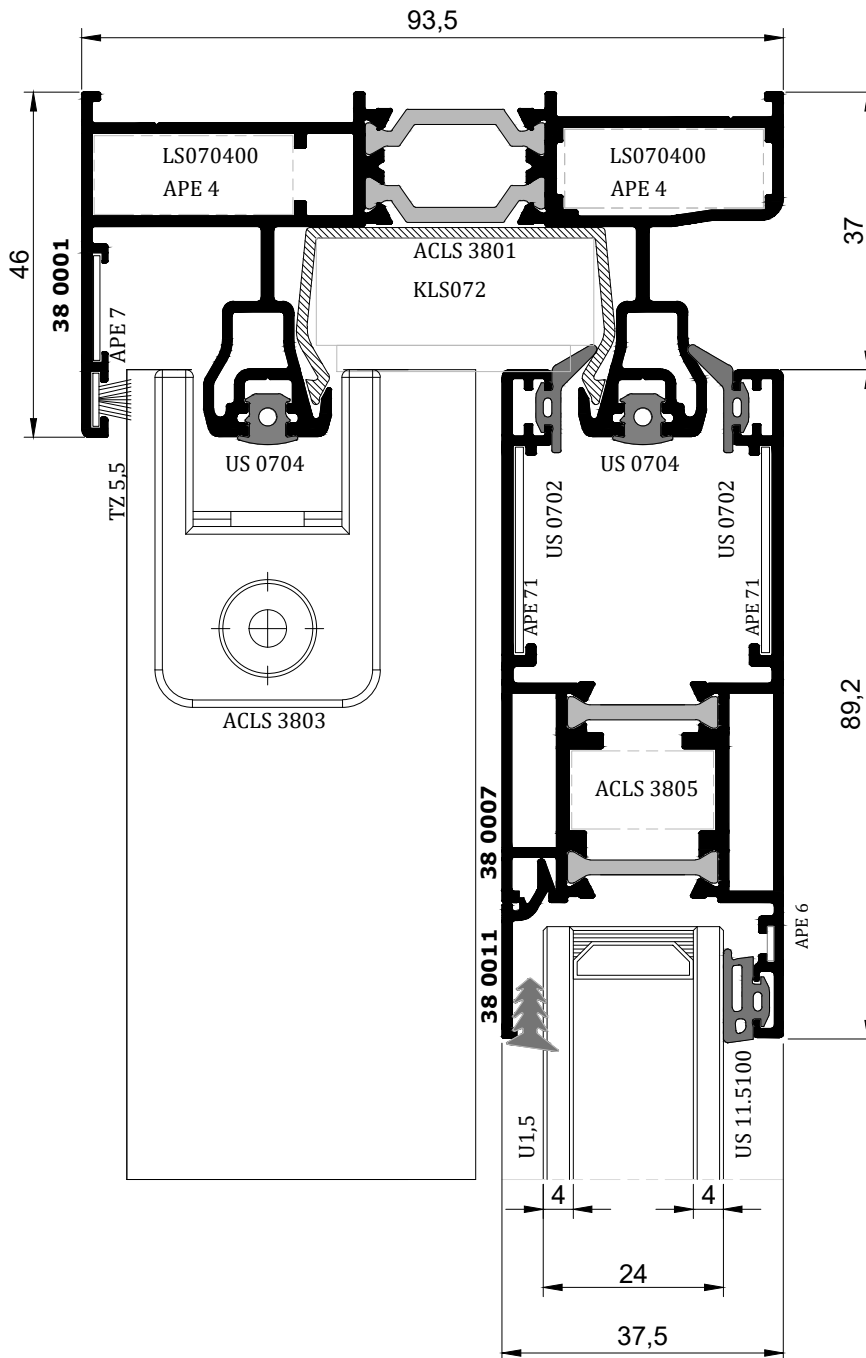
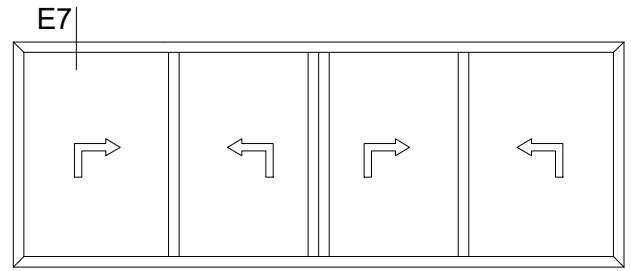

E7

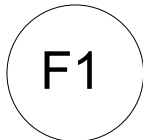
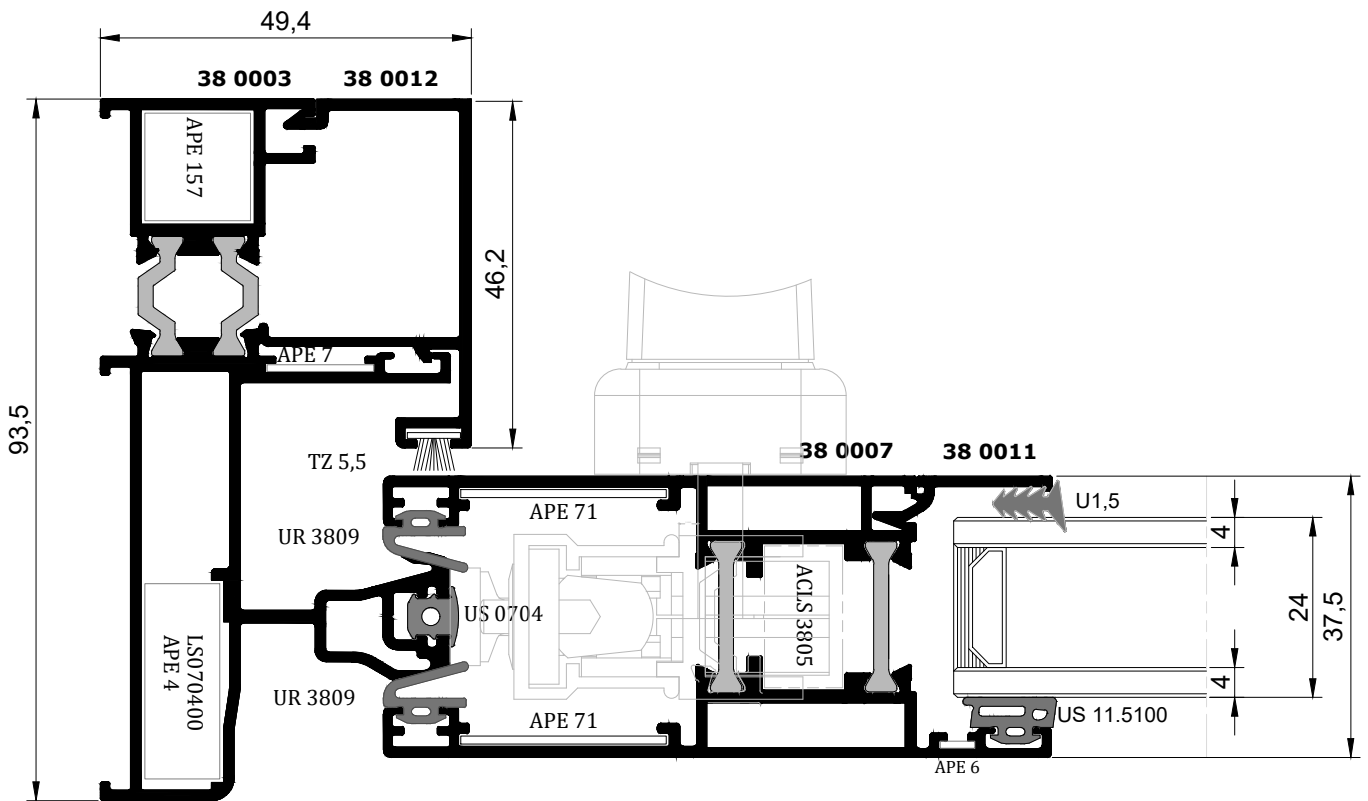
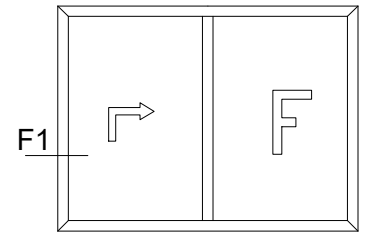

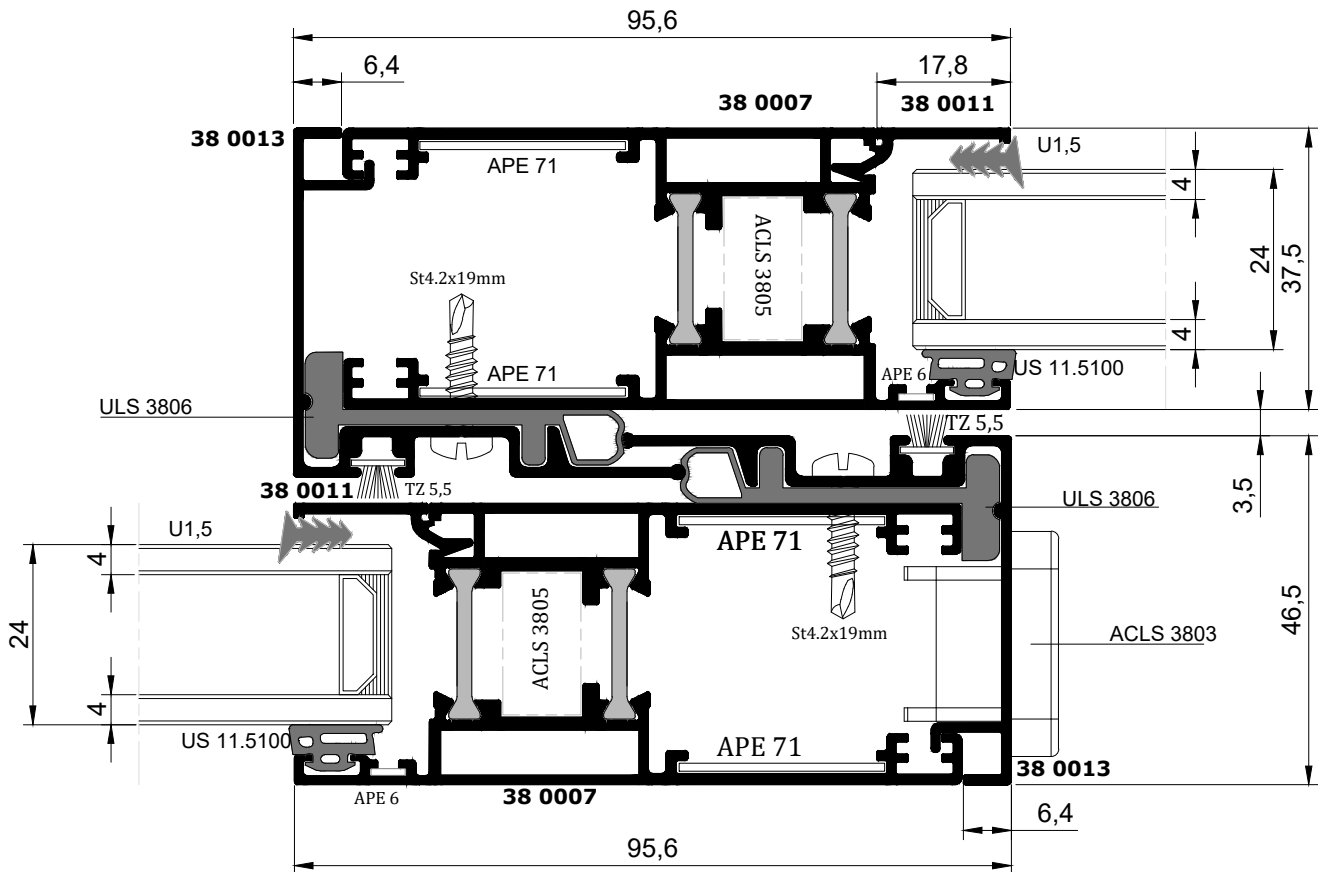
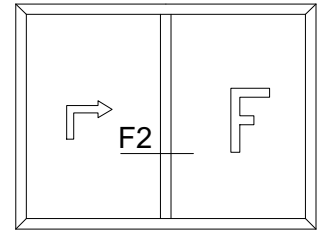

F2

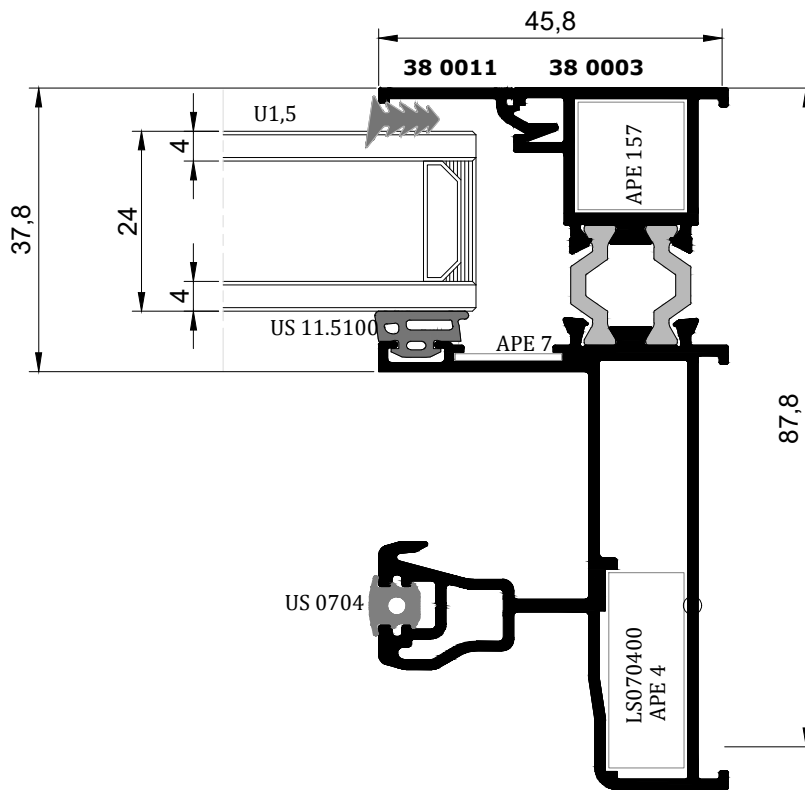
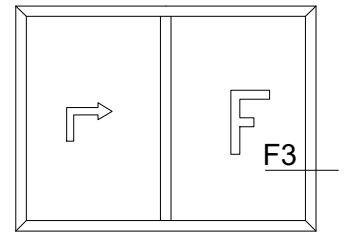

F3

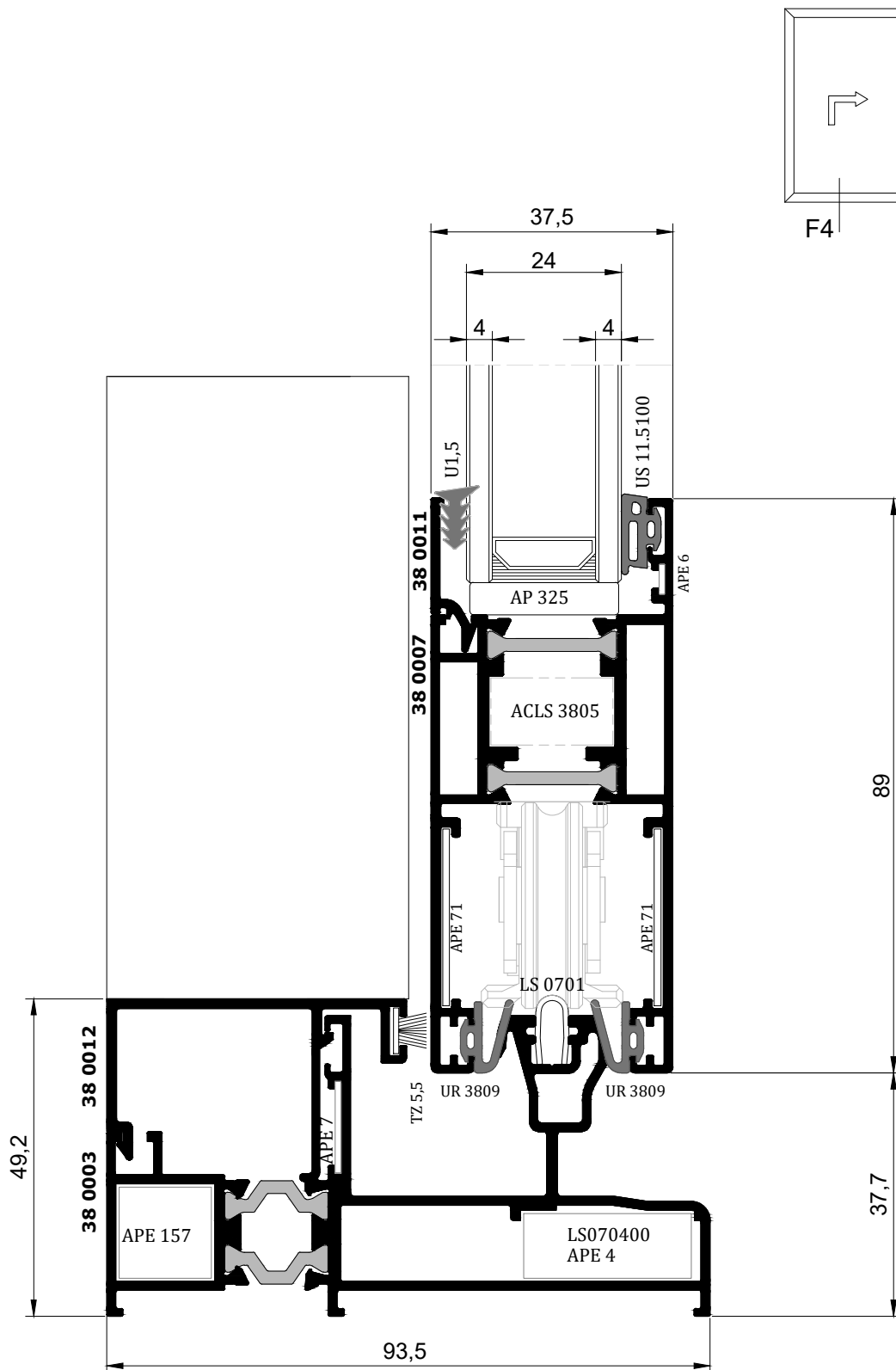

F4

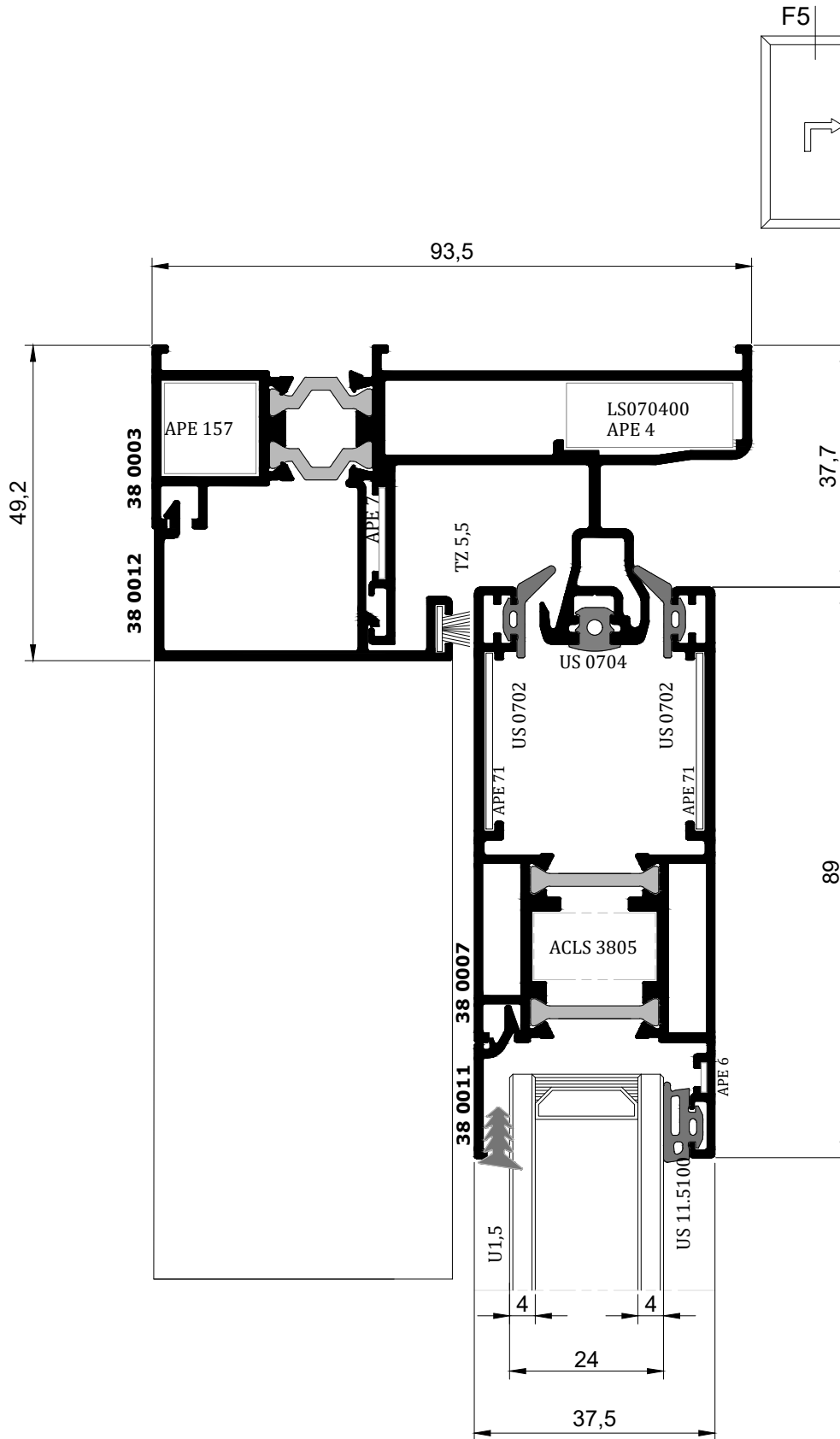

F5

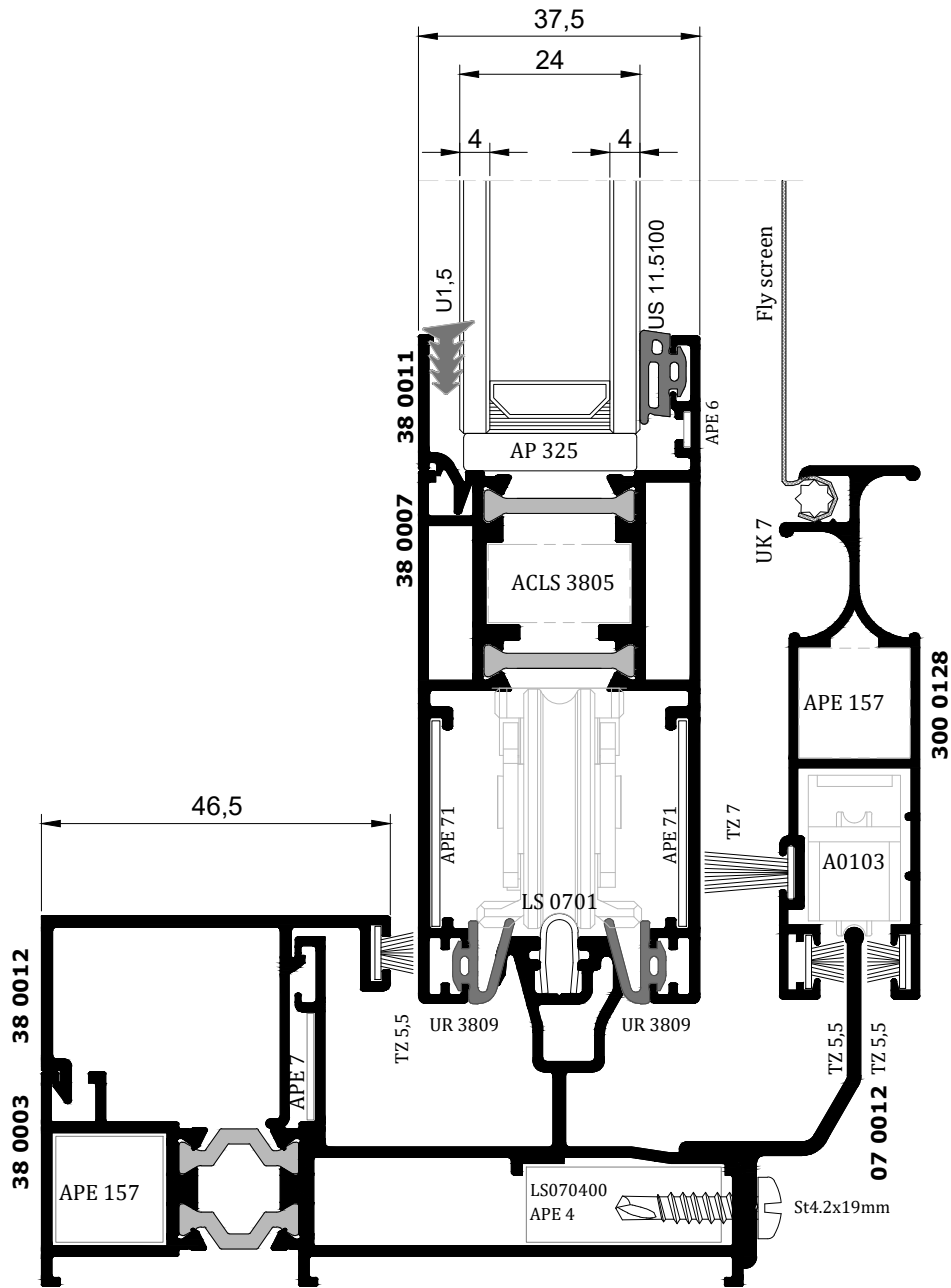
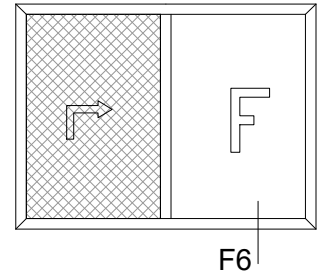

F6

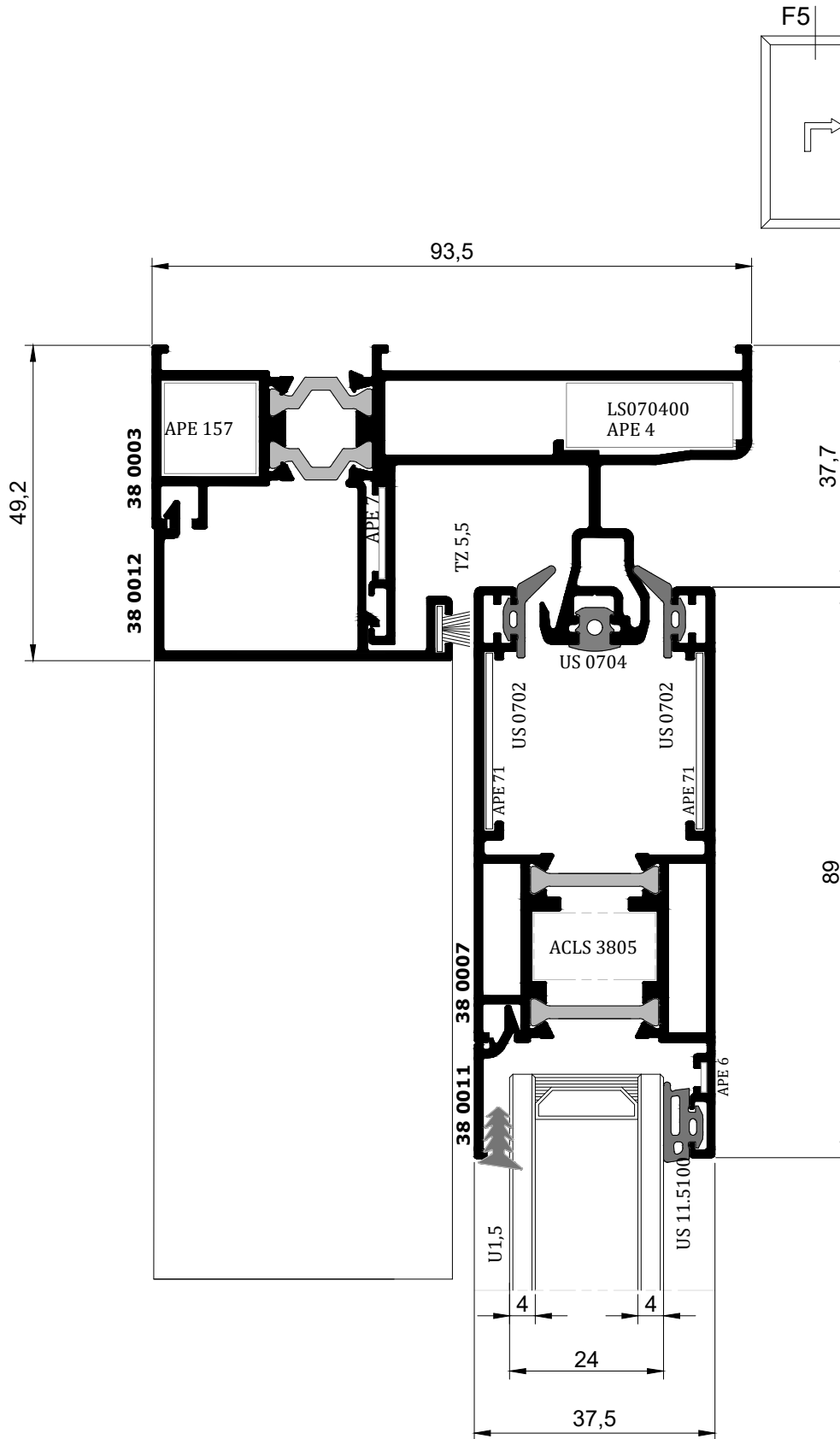

F5

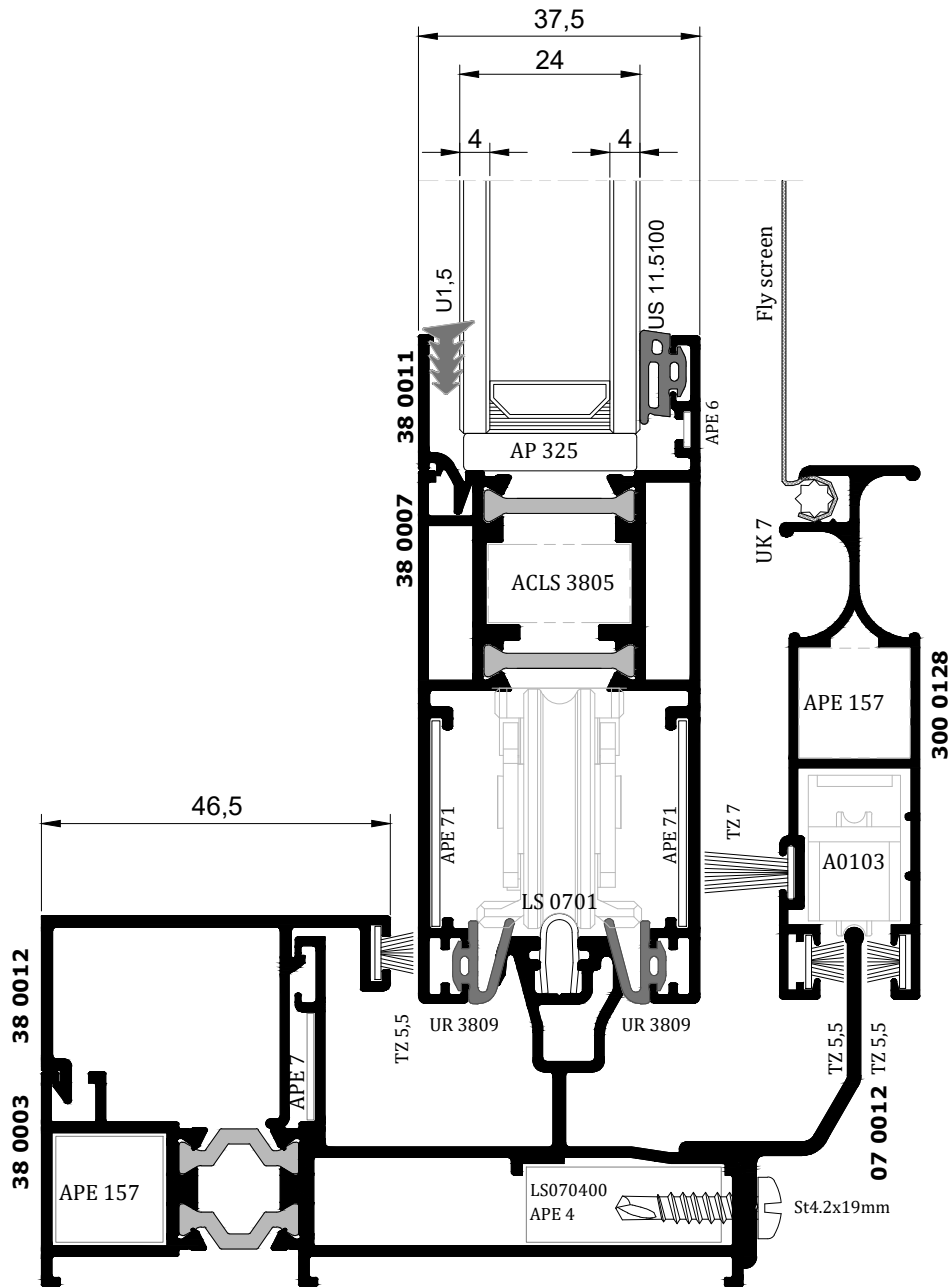
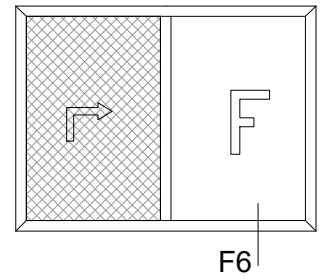

F6

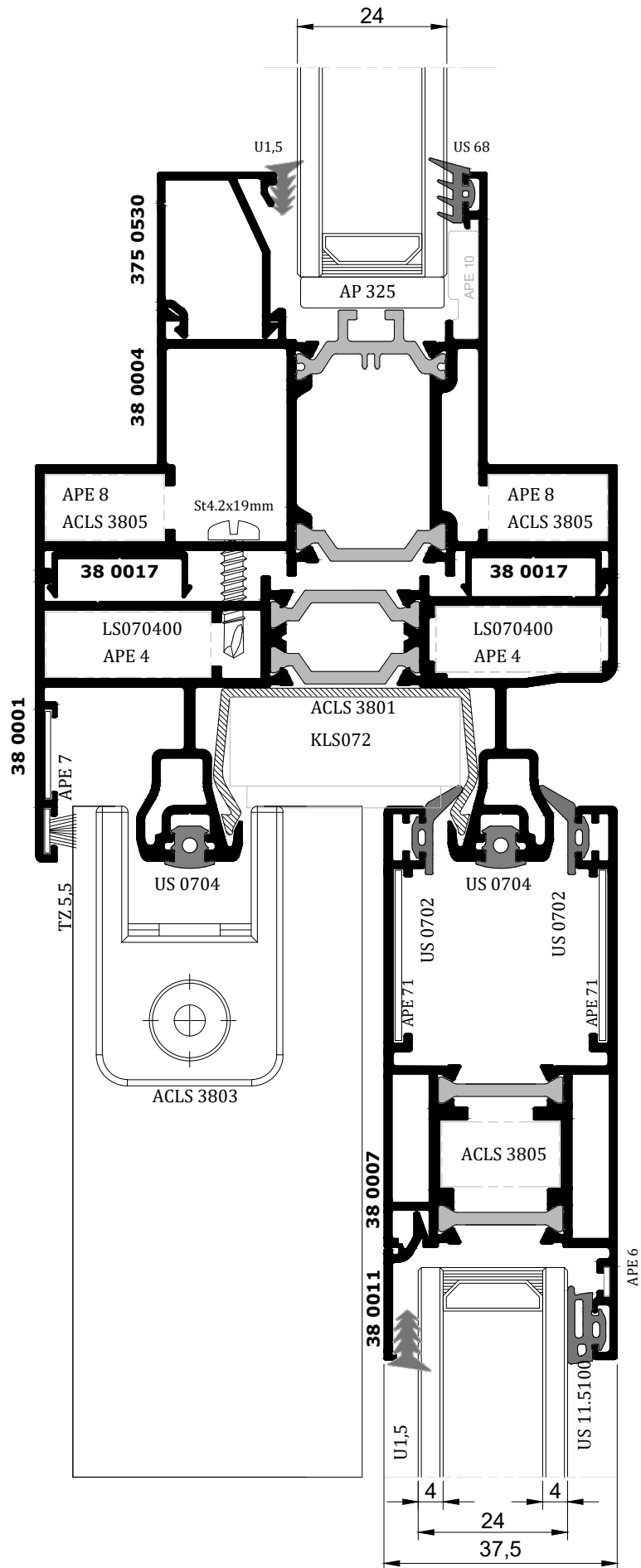

G1

SCALE 1:1

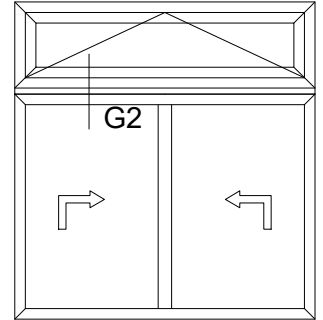
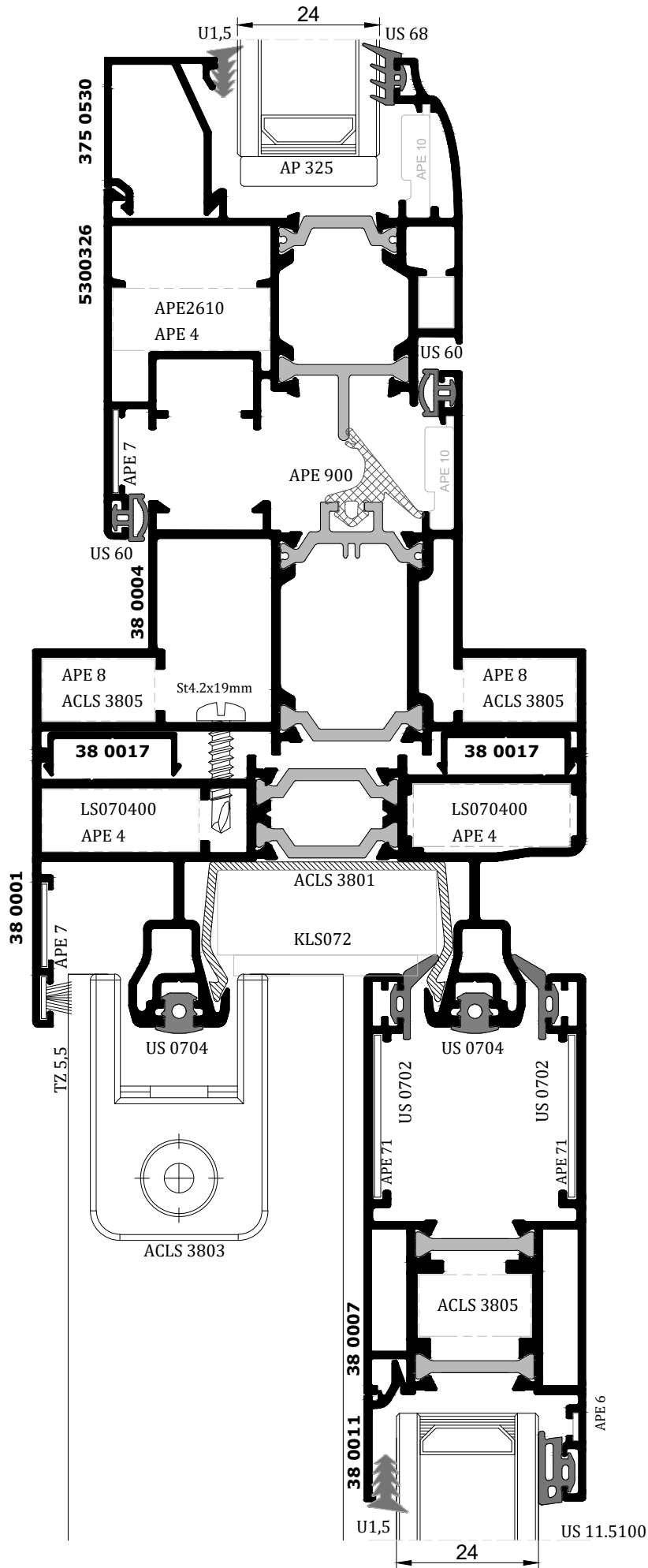

G2

SCALE 1:1

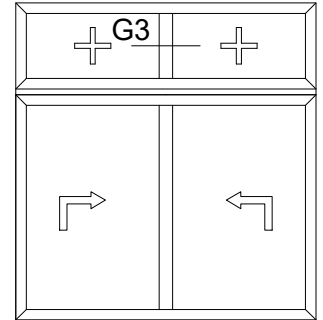
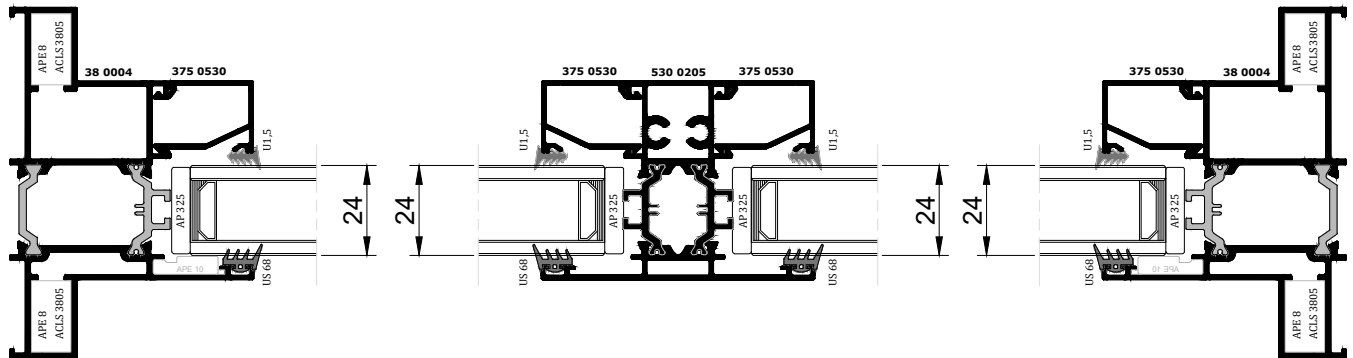

G3

***LIFT & SLIDE 38
SYSTEM***

CUTTING LIST



TYOLOGIES LIFT & SLIDE 38 SYSTEM

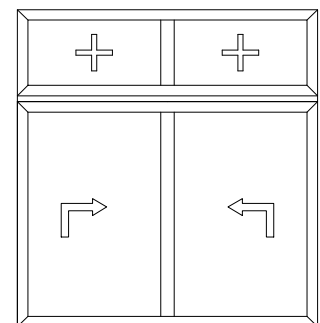
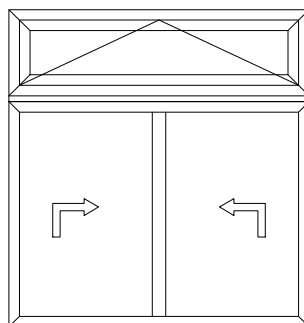
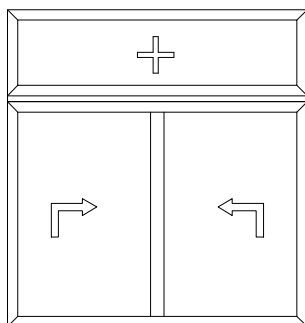
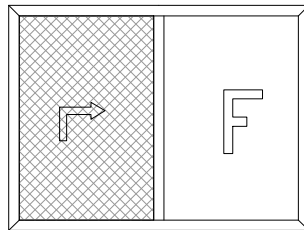
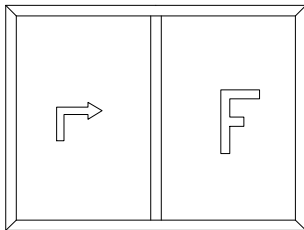
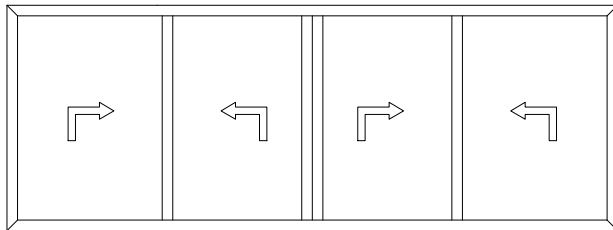
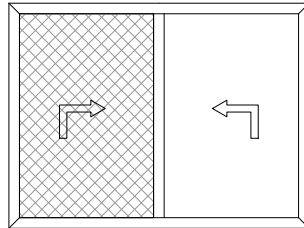
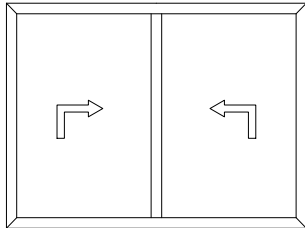

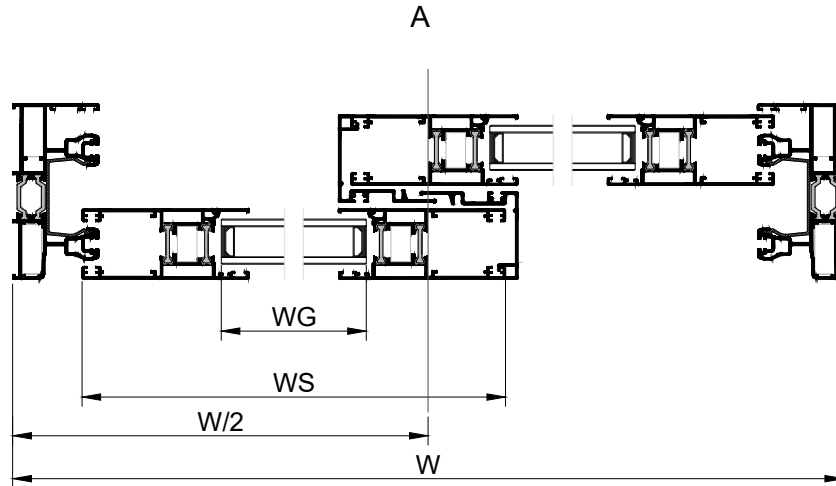
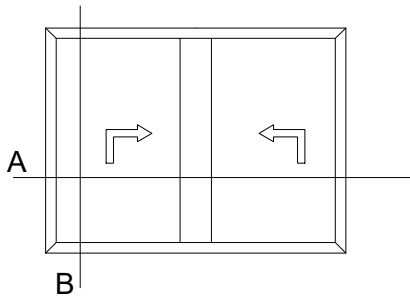

B

PROFILE CUTTING		
Description	Dimensions	Cut
Frame width	W	45°-45°
Frame height	H	45°-45°
Sash width	$WS = \frac{W + 8.55\text{mm}}{2}$	45°-45°
Sash height	$HS = H - 74\text{mm}$	45°-45°
Hook height	$HH = HS$	90°-90°
Glass width	$WG = WS - 148.4\text{mm}$	90°-90°
Glass height	$HG = HS - 148.4\text{mm}$	90°-90°

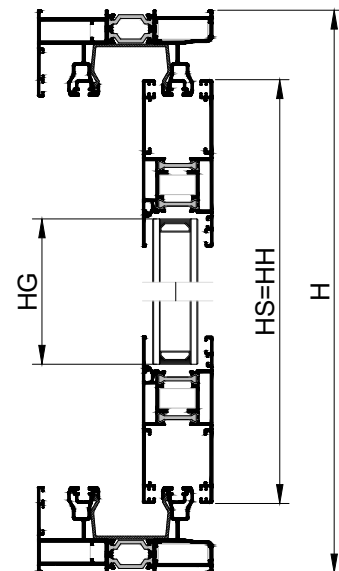

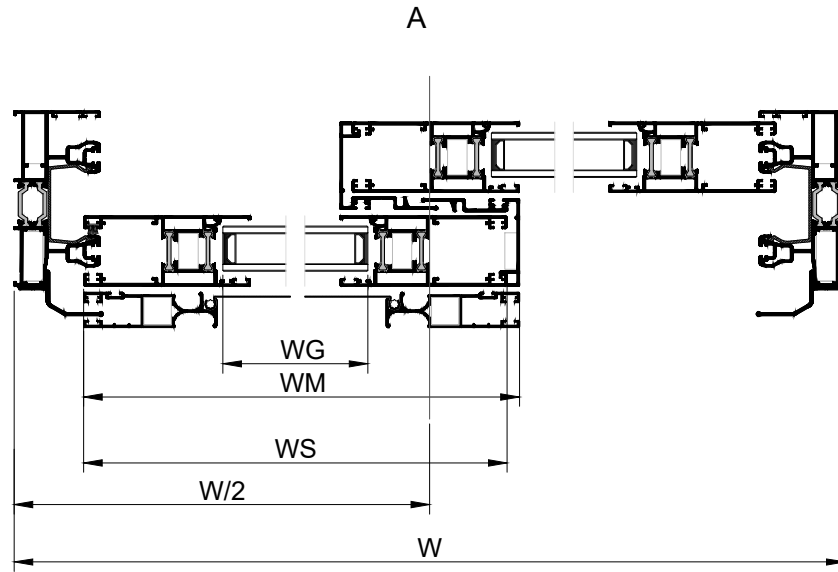
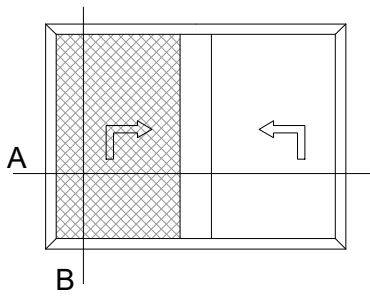

PROFILE CUTTING		
Description	Dimensions	Cut
Frame width	W	45°-45°
Frame height	H	45°-45°
Sash width	$WS = \frac{W+8.55\text{mm}}{2}$	45°-45°
Sash height	$HS = H - 74\text{mm}$	45°-45°
Hook height	$HH = HS$	90°-90°
Mosquito profile width	$WM = WS + 6.5\text{mm}$	45°-45°
Mosquito profile height	$HM = HS$	45°-45°
Glass width	$WG = WS - 148.4\text{mm}$	90°-90°
Glass height	$HG = HS - 148.4\text{mm}$	90°-90°

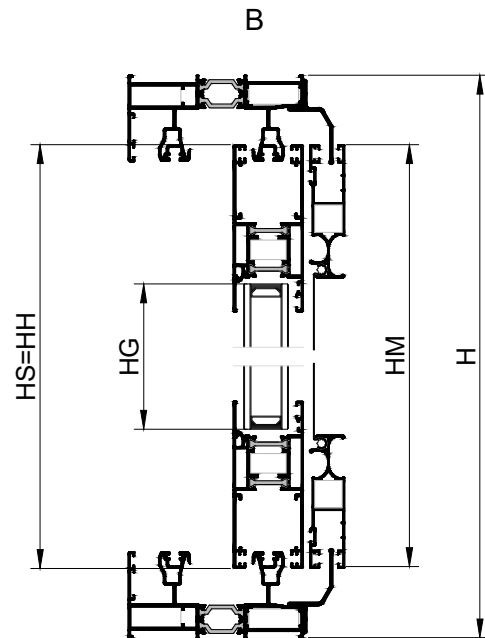

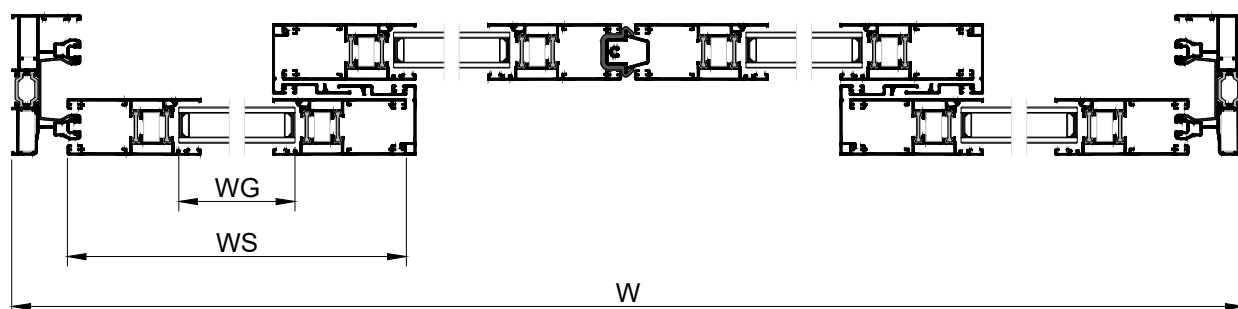
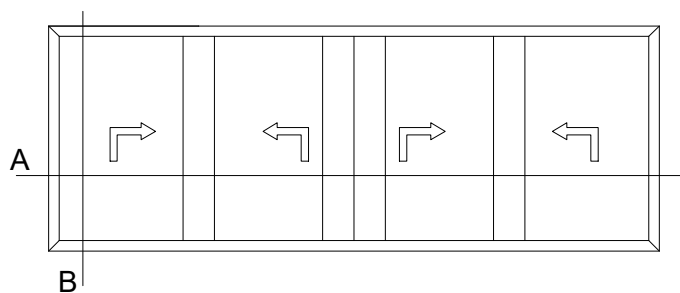

PROFILE CUTTING		
Description	Dimensions	
Frame width	W	45°-45°
Frame height	H	45°-45°
Sash width	$WS = \frac{W+82.1\text{mm}}{4}$	45°-45°
Sash height	$HS = H - 74\text{mm}$	45°-45°
Hook height	$HH = HS$	90°-90°
Meeting stile profile	$HME = HS - 70\text{mm}$	90°-90°
Glass width	$WG = WS - 148.4\text{mm}$	90°-90°
Glass height	$HG = HS - 148.4\text{mm}$	90°-90°

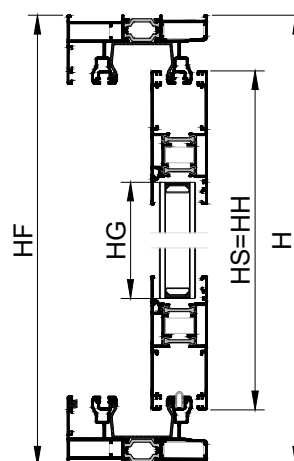

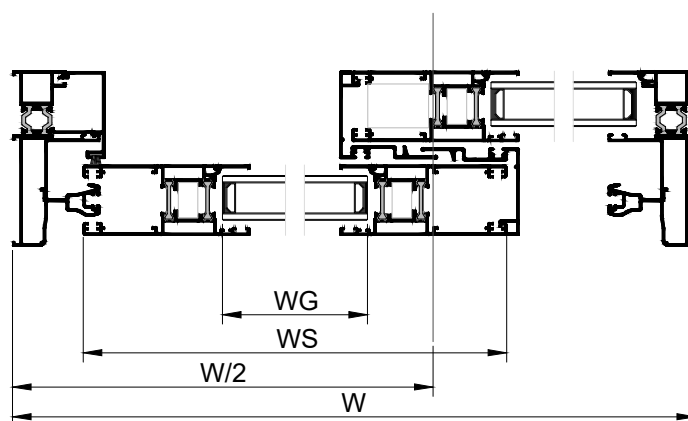
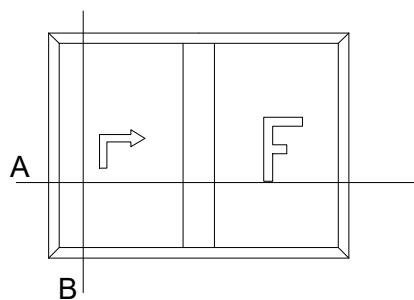

PROFILE CUTTING		
Description	Dimensions	Cut
Frame width	W	45°-45°
Frame height	H	45°-45°
Sash width	$WS=(W/2)+1,5\text{mm}$	45°-45°
Sash height	$HS=H-75,4\text{mm}$	45°-45°
Hook height	$HH=HS$	90°-90°
Glass width	$WG=WS-148.4\text{mm}$	90°-90°
Glass height	$HG=HS-148.4\text{mm}$	90°-90°

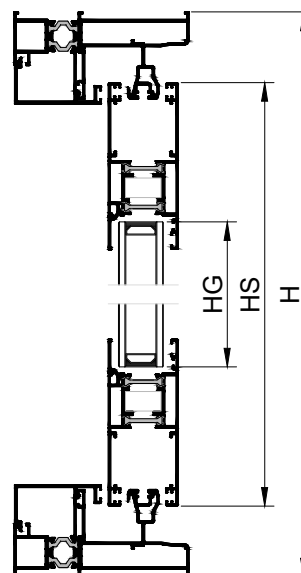

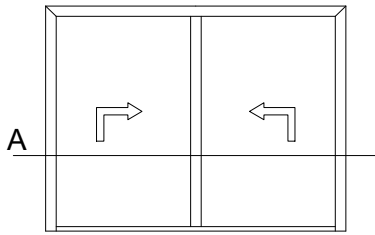

CUTTING LIST (Low threshold)

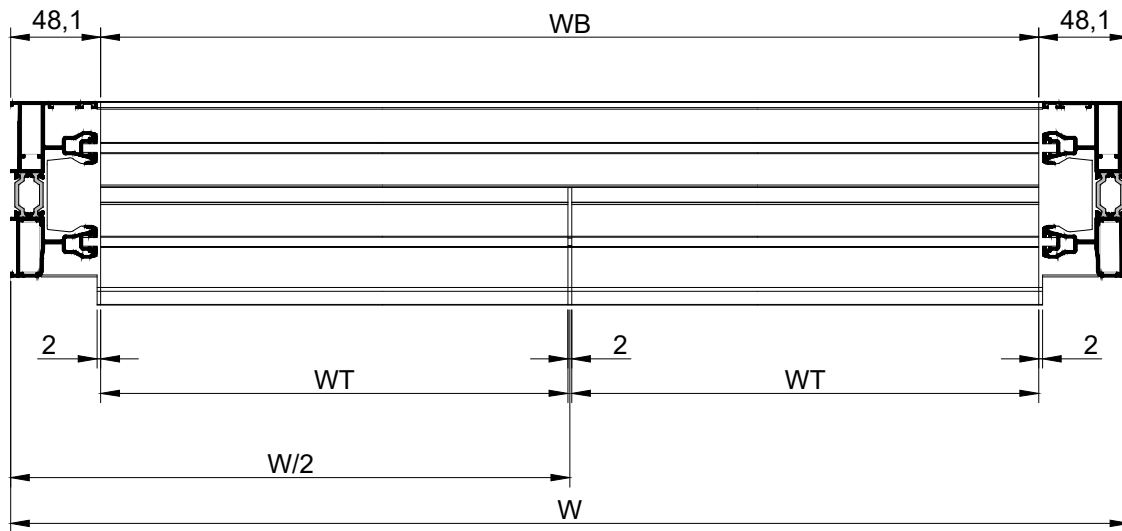

PROFILE CUTTING		
Description	Dimensions	Cut
Frame width	W	45°-45°
Frame height	H	45°-45°
Threshold width	$WT=(W/2)-47\text{mm}$	90°-90°
Sash height	$HS=H-68\text{mm}$	45°-45°
Hook height	$HH=HS$	90°-90°
Base threshold width	$WB=W-96\text{ mm}$	90°-90°
Glass height	$HG=HS-152\text{ mm}$	90°-90°

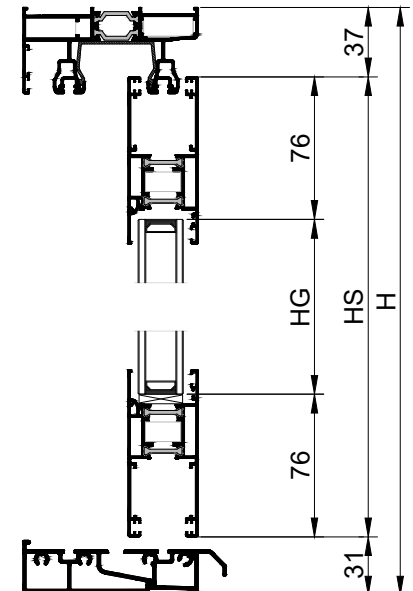

SLIDE 38
&
LIFT & SLIDE 38
SYSTEM

THREE DIMENSIONS
DETAILS



*Double rail frame connection
with mechanical corner*

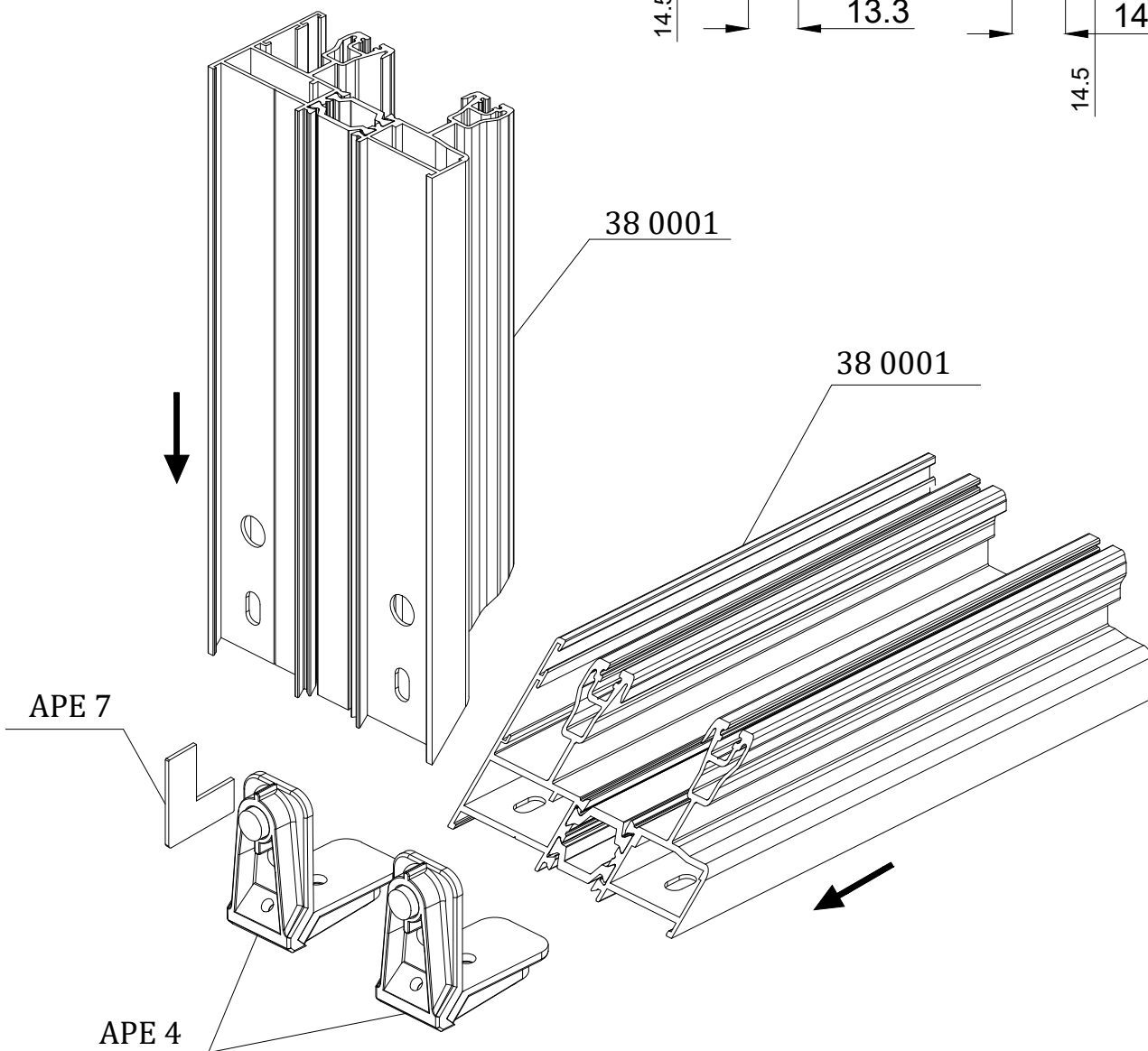
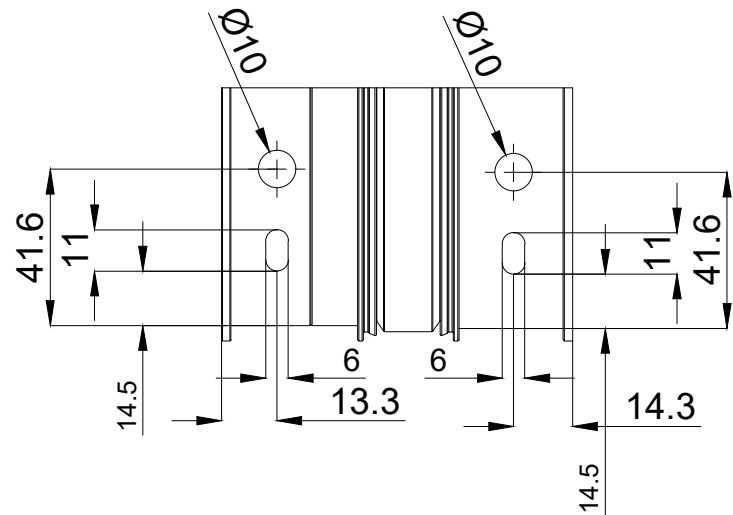

Double rail frame connection with press corner

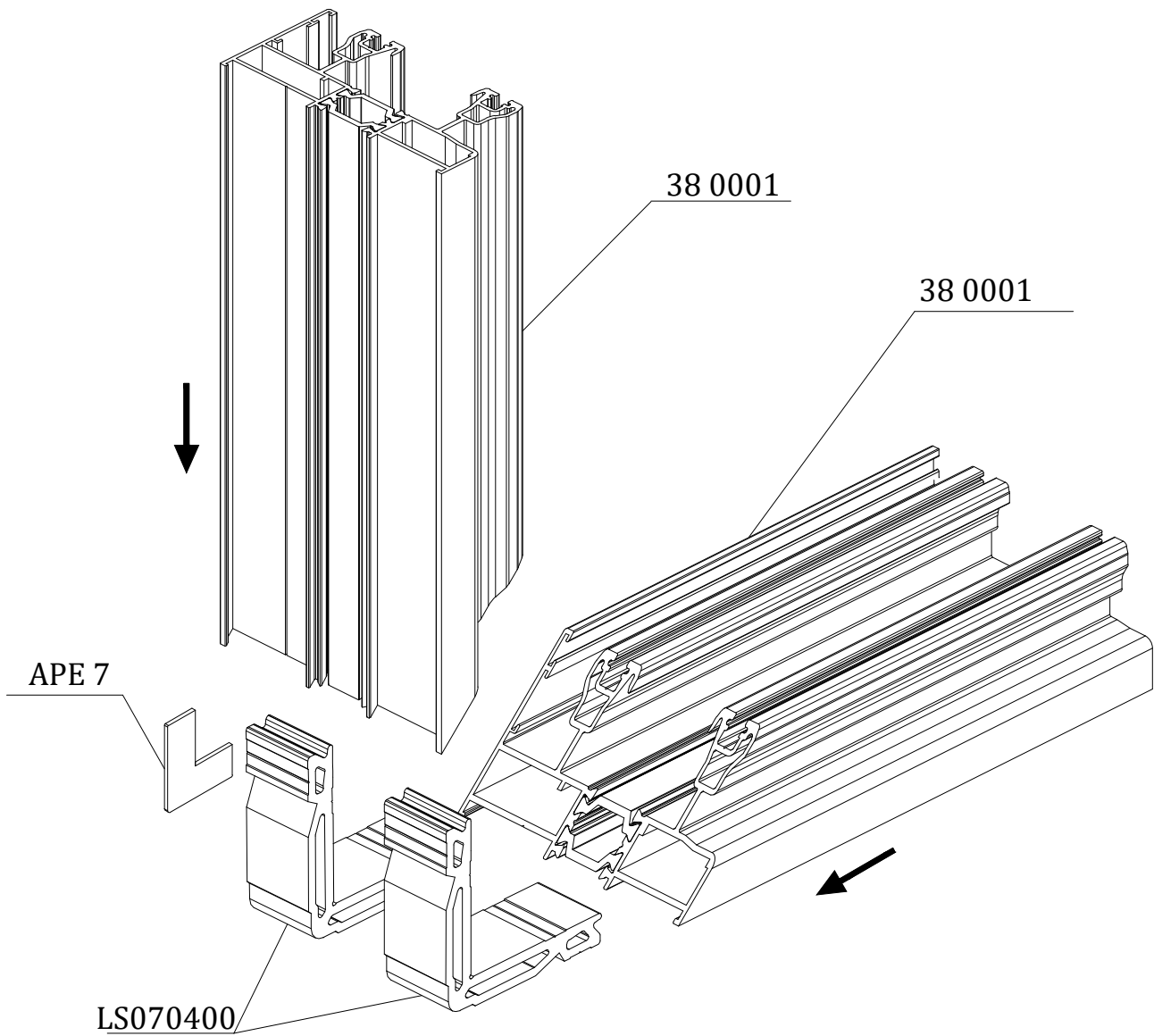

*Double rail frame connection
with mechanical corner*

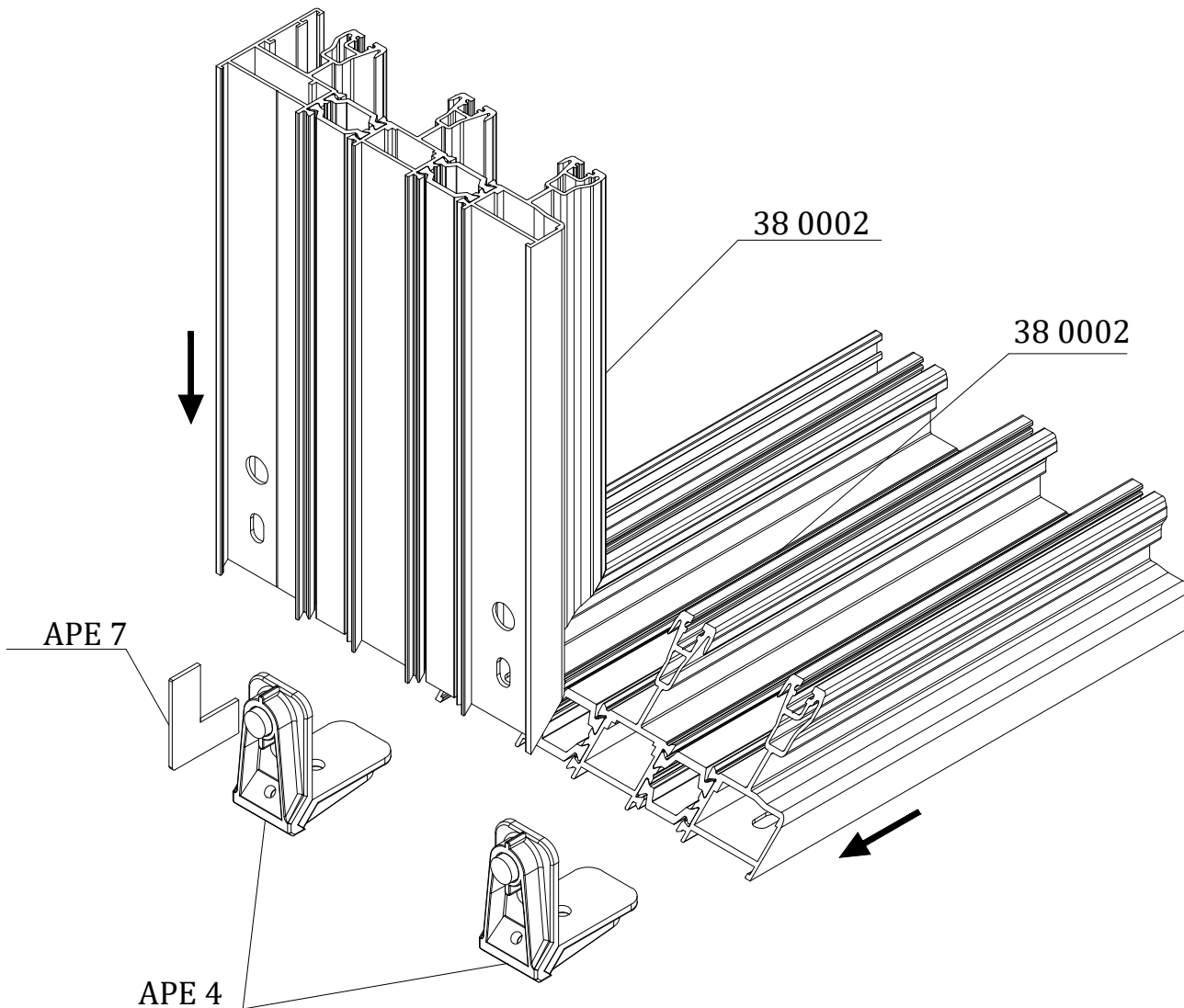
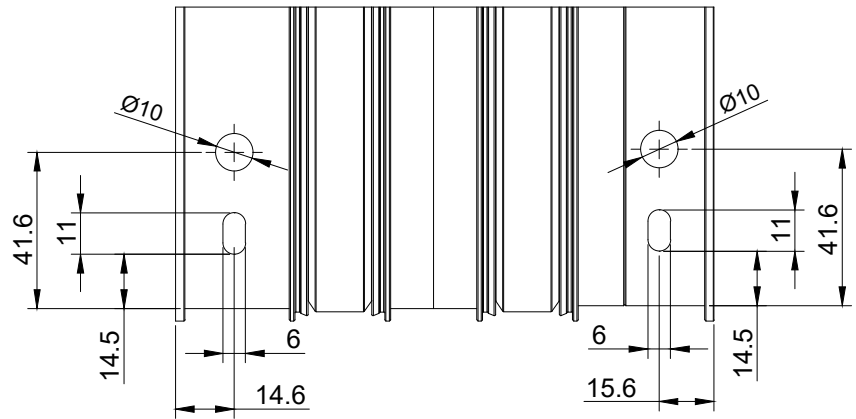

Double rail frame connection with press corner

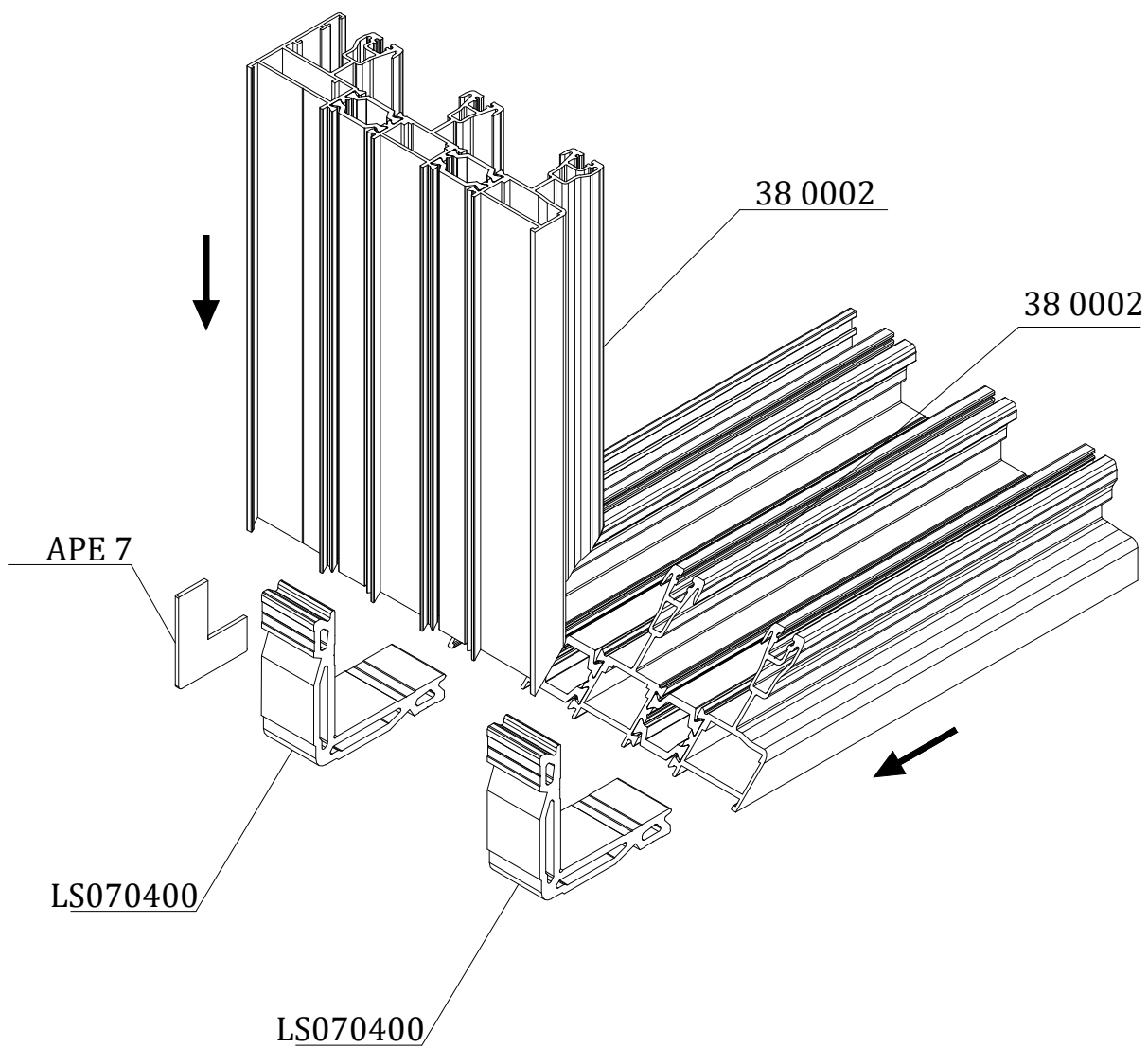

Single rail frame connection with mechanical corner

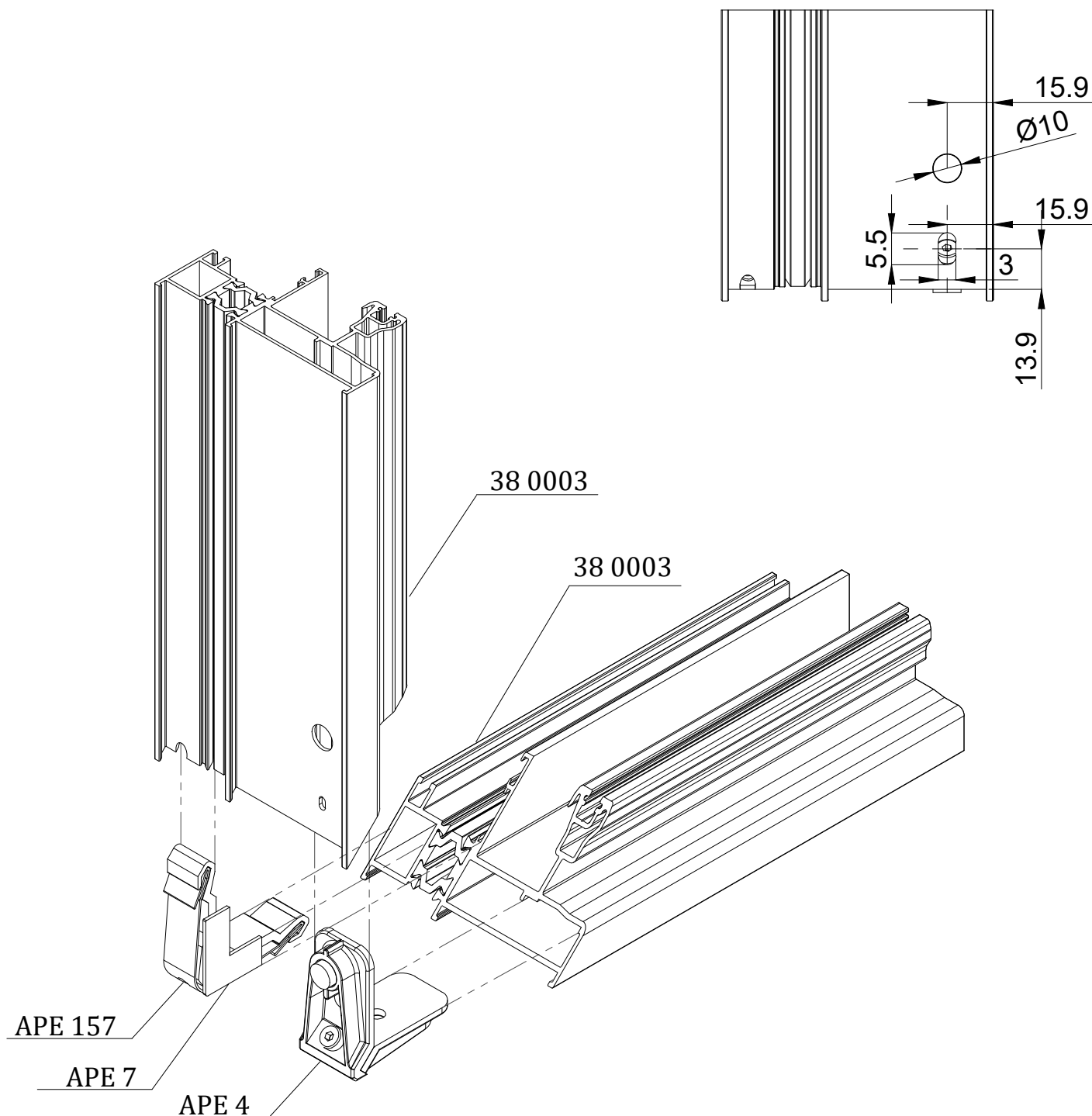

Sash connection with "CAL" corner

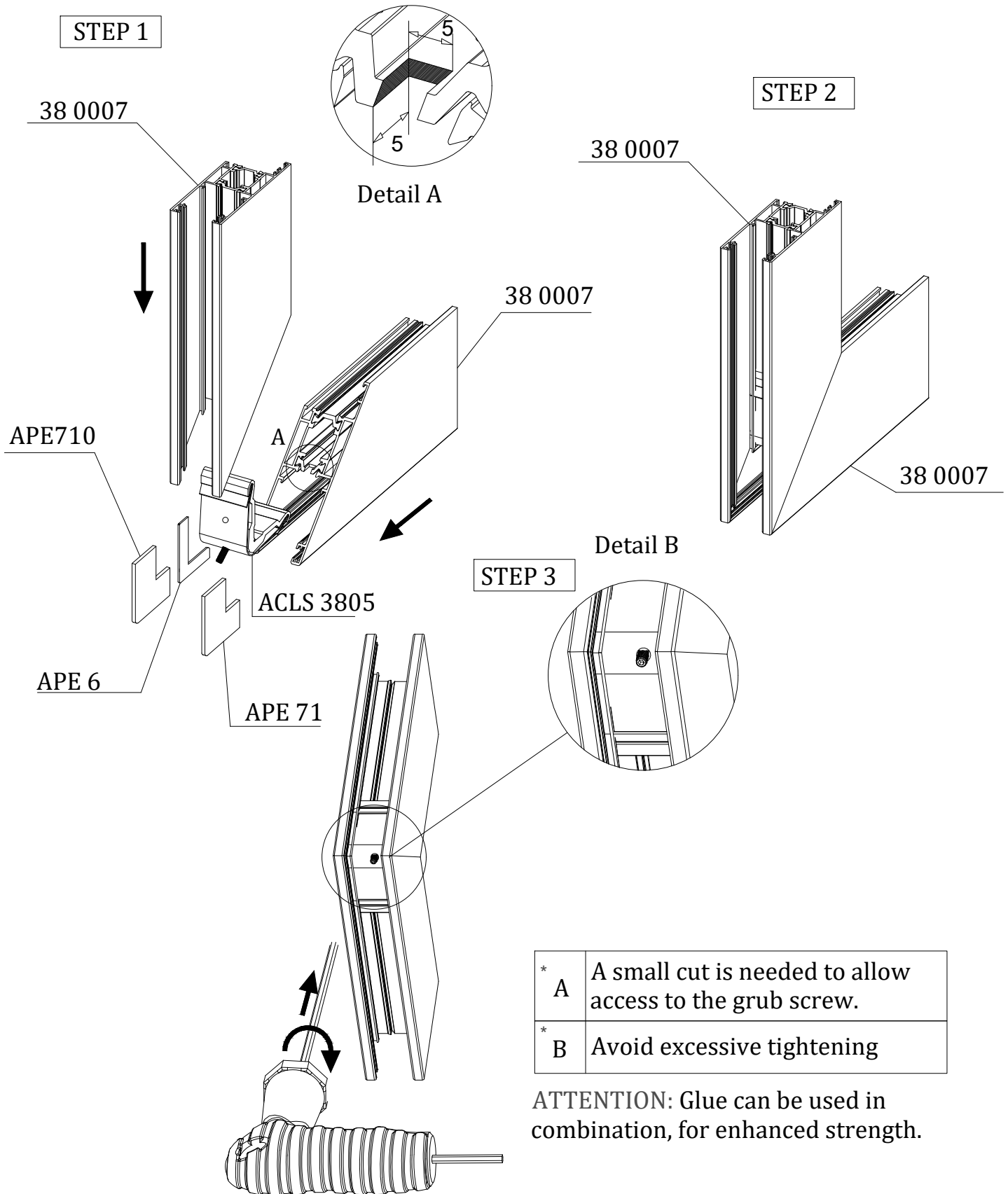

Sash fixing assembly on single rail frame

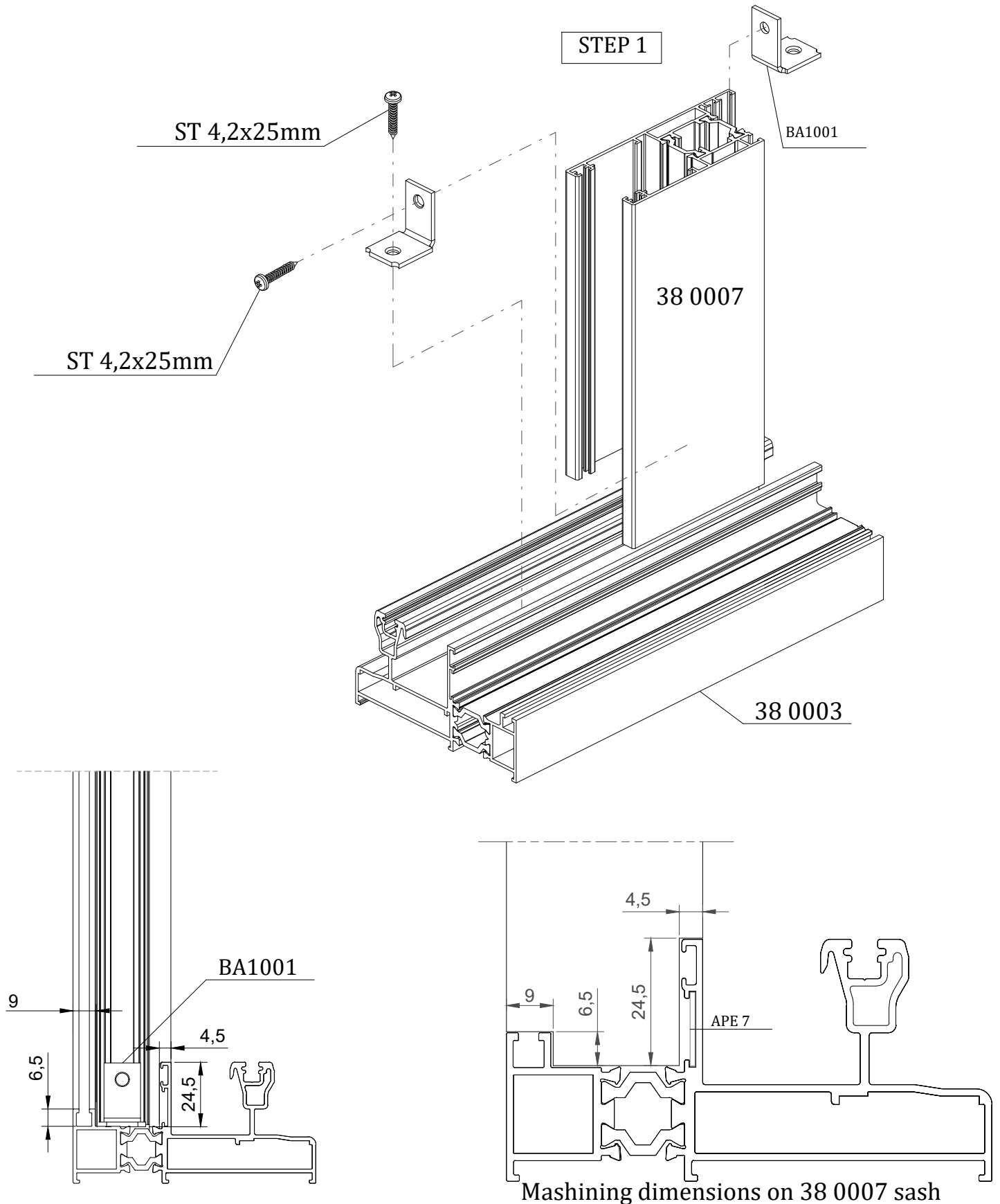

Cover assembly for single rail frame

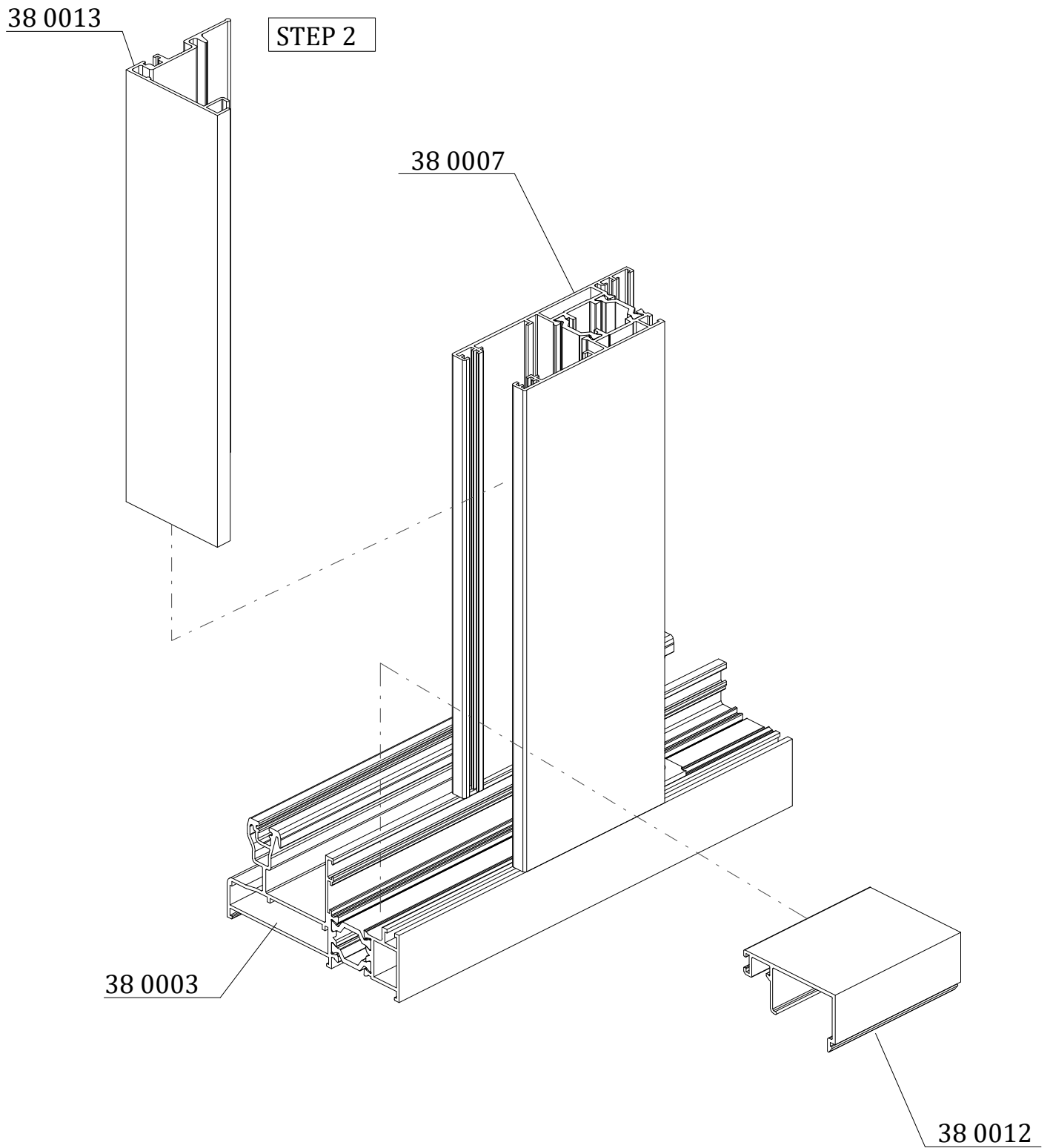

SLIDE 38 SYSTEM

THREE DIMENSIONS DETAILS



*Milling for water drainage at bottom
frame member-Double rail frame*

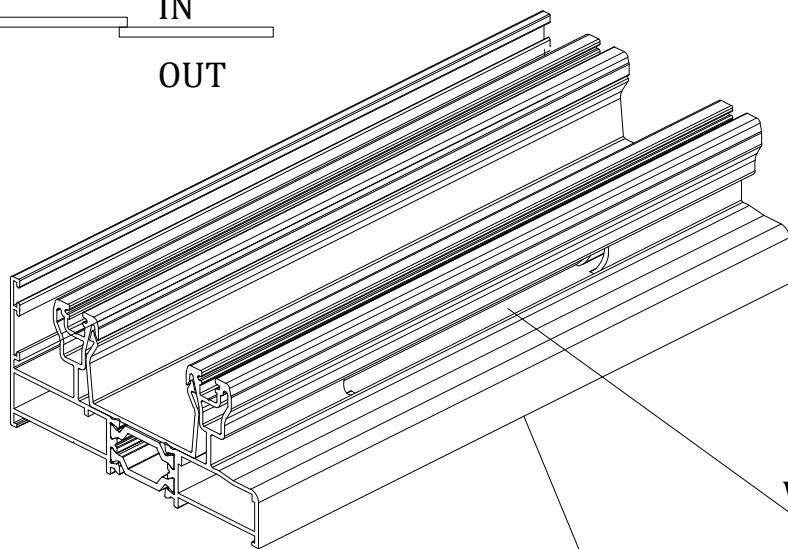
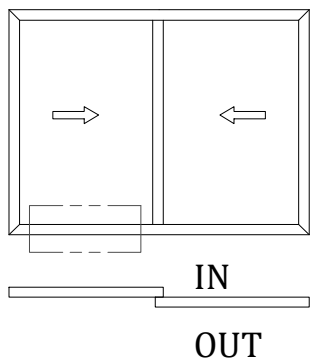

Weep hole milling 10x100mm

Weep hole milling 10X100mm

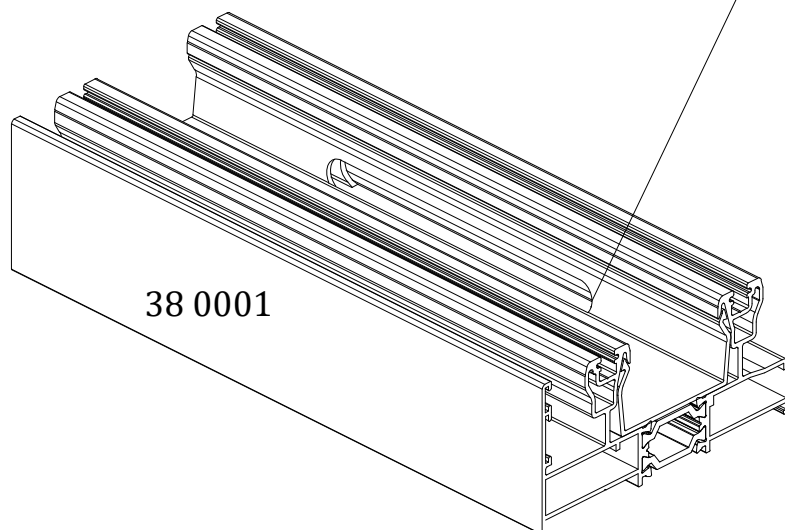

*Milling for water drainage at
bottom frame member-Triple
rail frame*

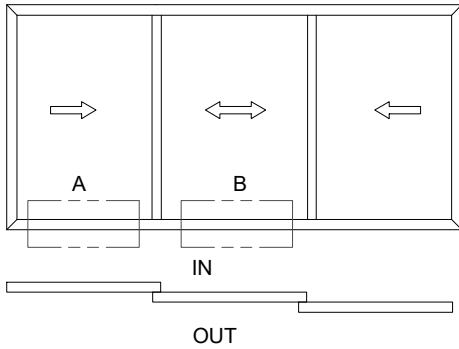

AREA A
Weep hole milling
10x100mm

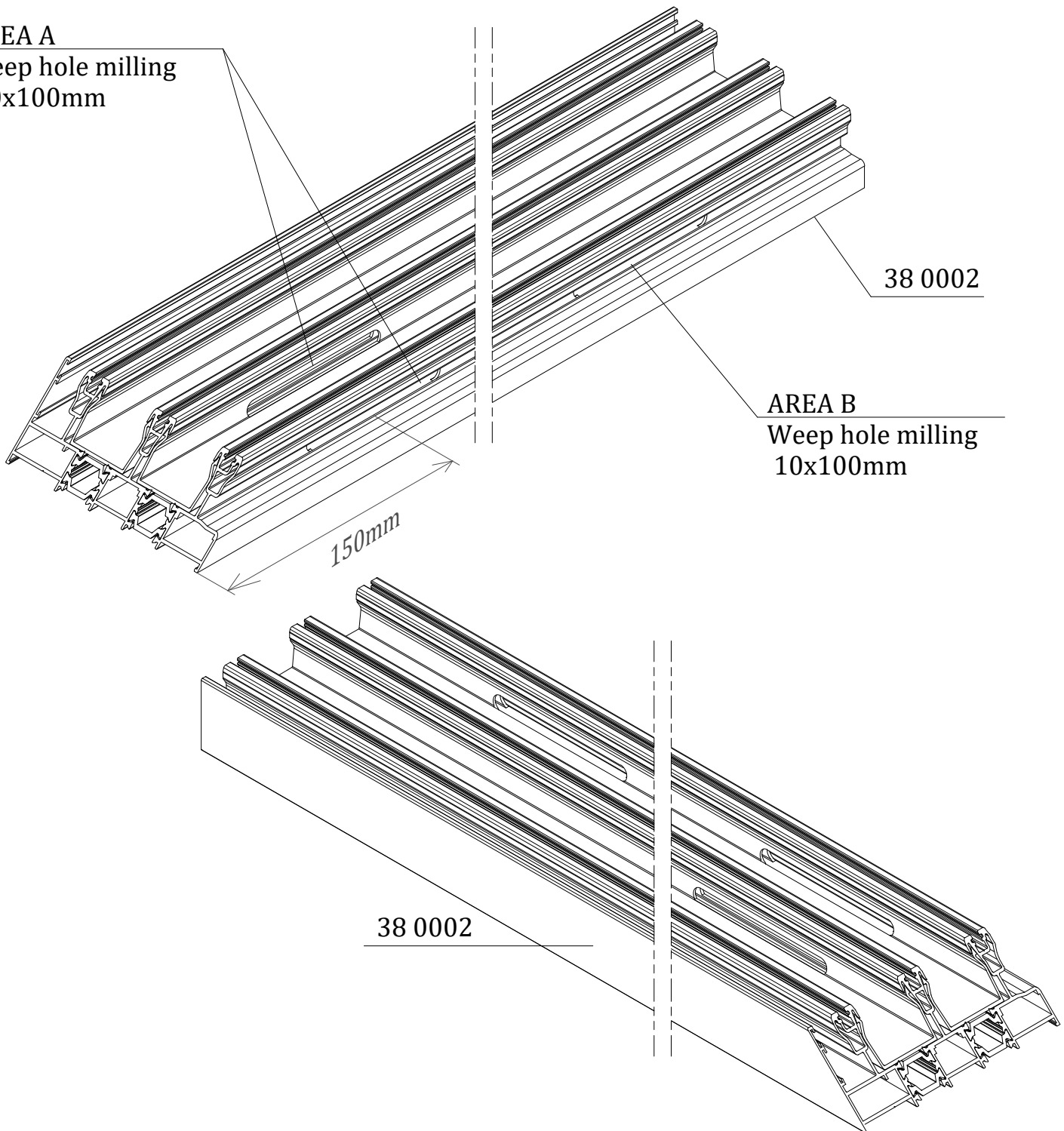

38 0002

AREA B
Weep hole milling
10x100mm

38 0002

THREE DIMENSIONS DETAILS
*Sash assembly with narrow hook profile
using connector 38 0007*

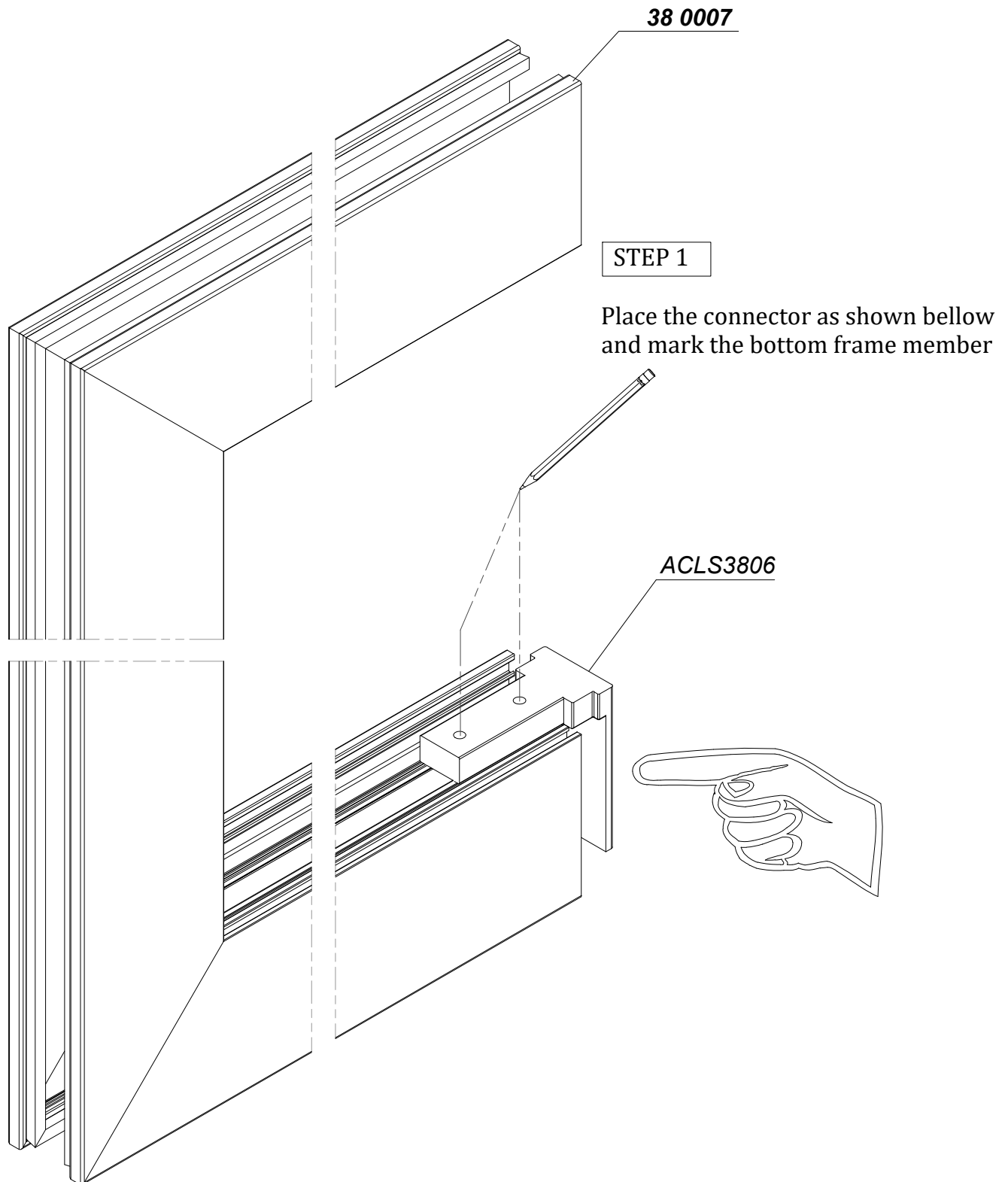

THREE DIMENSIONS DETAILS

Sash assembly with narrow hook profile using connector ACLS3806

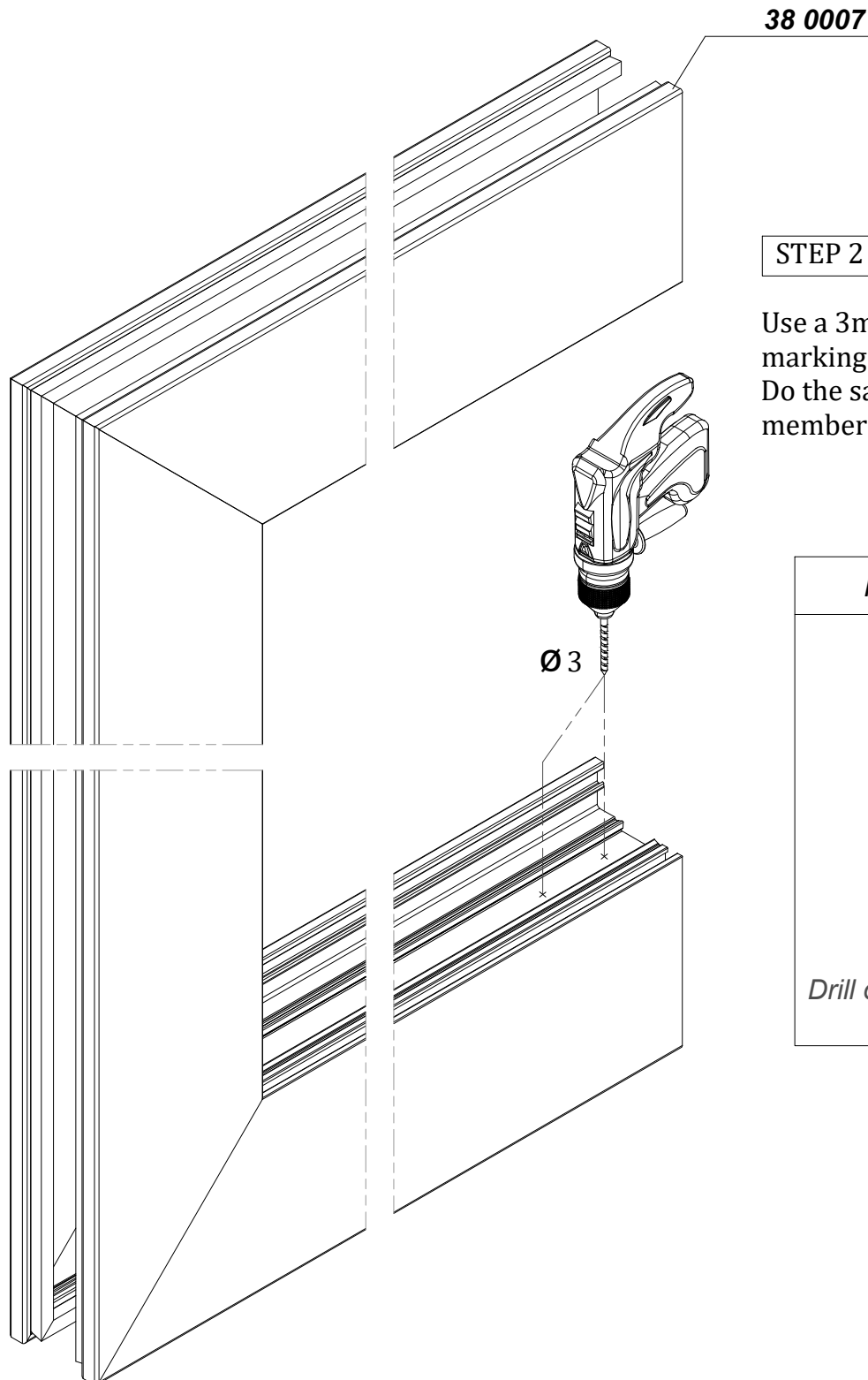

STEP 2

Use a 3mm drill beat and drill on marking points.
Do the same on the upper frame member.

Important!

Drill only one side of polyamide

THREE DIMENSIONS DETAILS

Sash assembly with narrow hook profile using connector ACLS3806

STEP 3

Insert AC38T 31 in the camber as shown bellow and fix with screws St 4.2x25mm from top to bottom.

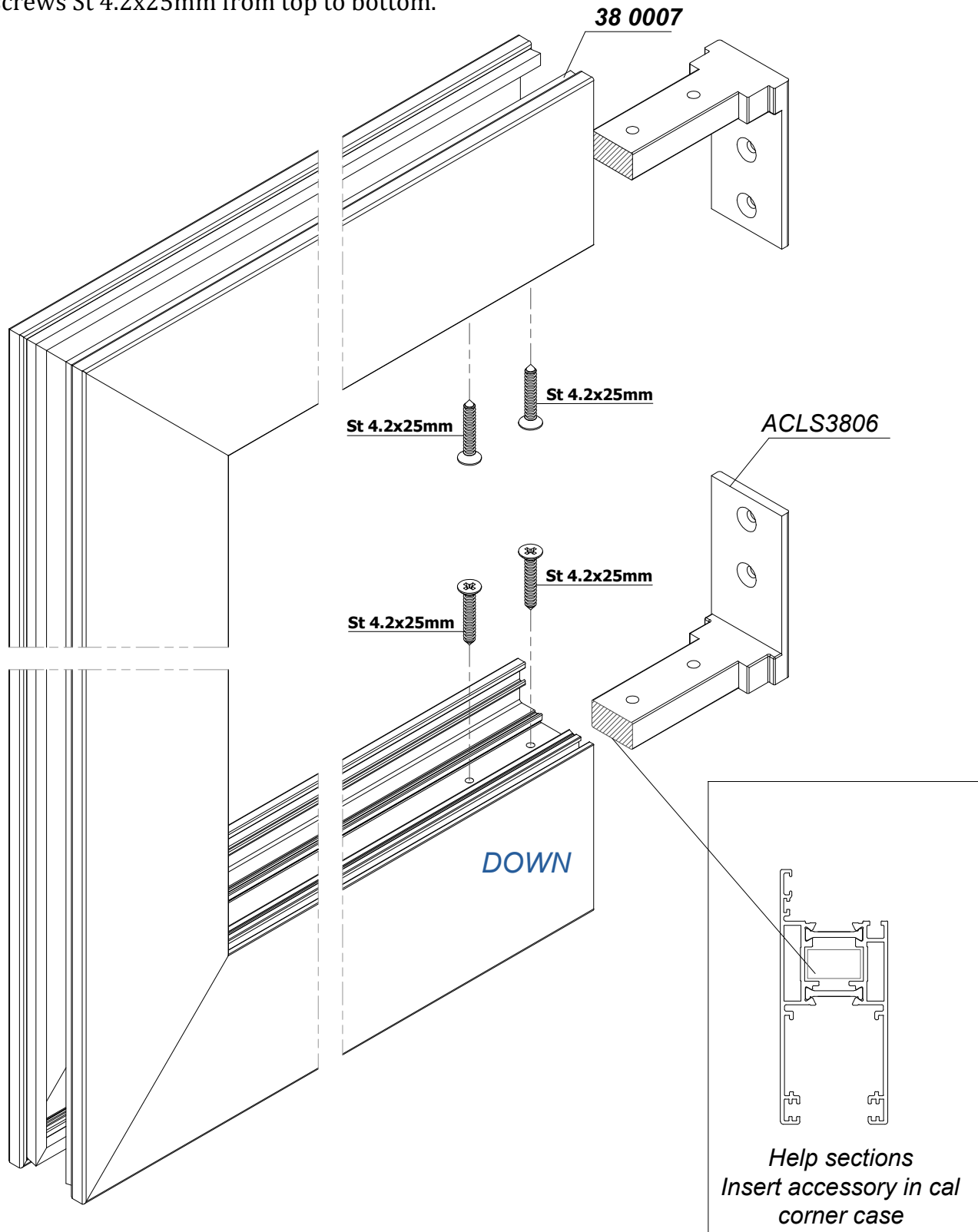

THREE DIMENSIONS DETAILS Sash assembly with narrow hook profile using connector ACLS3806

STEP 4

Mount the narrow hook profile S38T 08 as shown below.

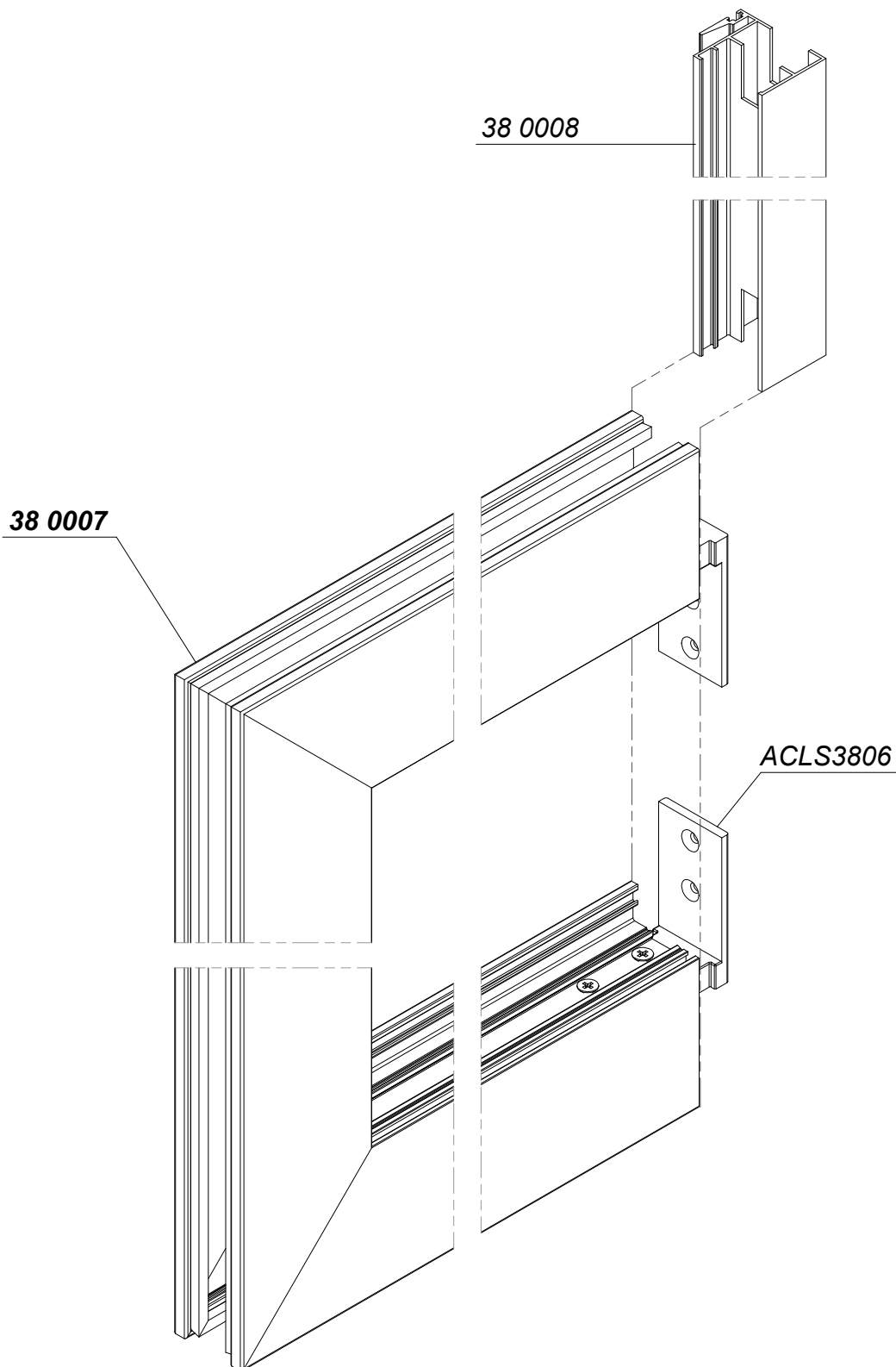

THREE DIMENSIONS DETAILS

Sash assembly with narrow hook profile using connector ACLS3806

STEP 5

Fix the hook profile with screws.

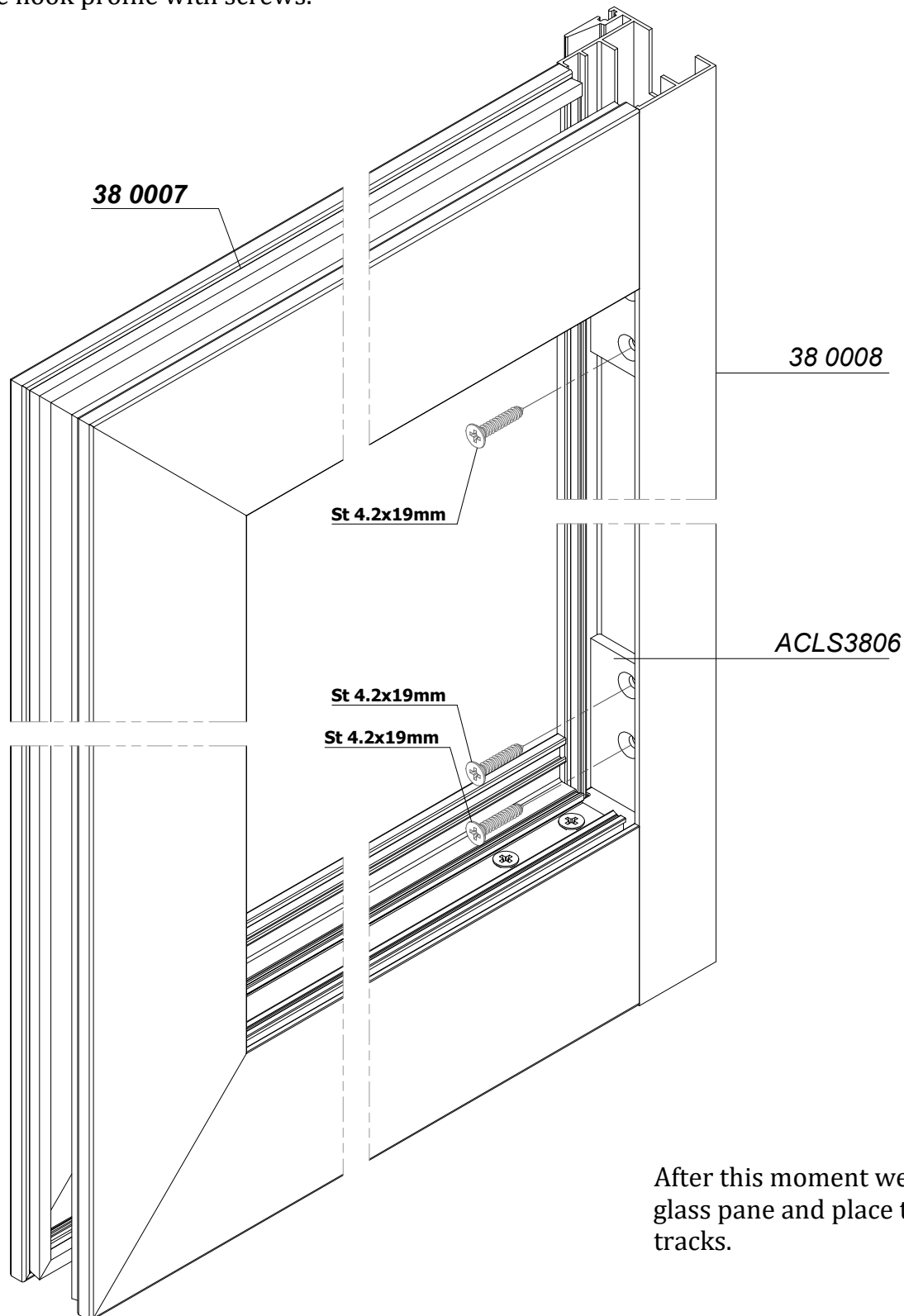

After this moment we could load the glass pane and place the assembly on tracks.

THREE DIMENSIONS DETAILS

Sash assembly with narrow hook profile using connector ACLS3806

STEP 6

Fix the hook end cap.

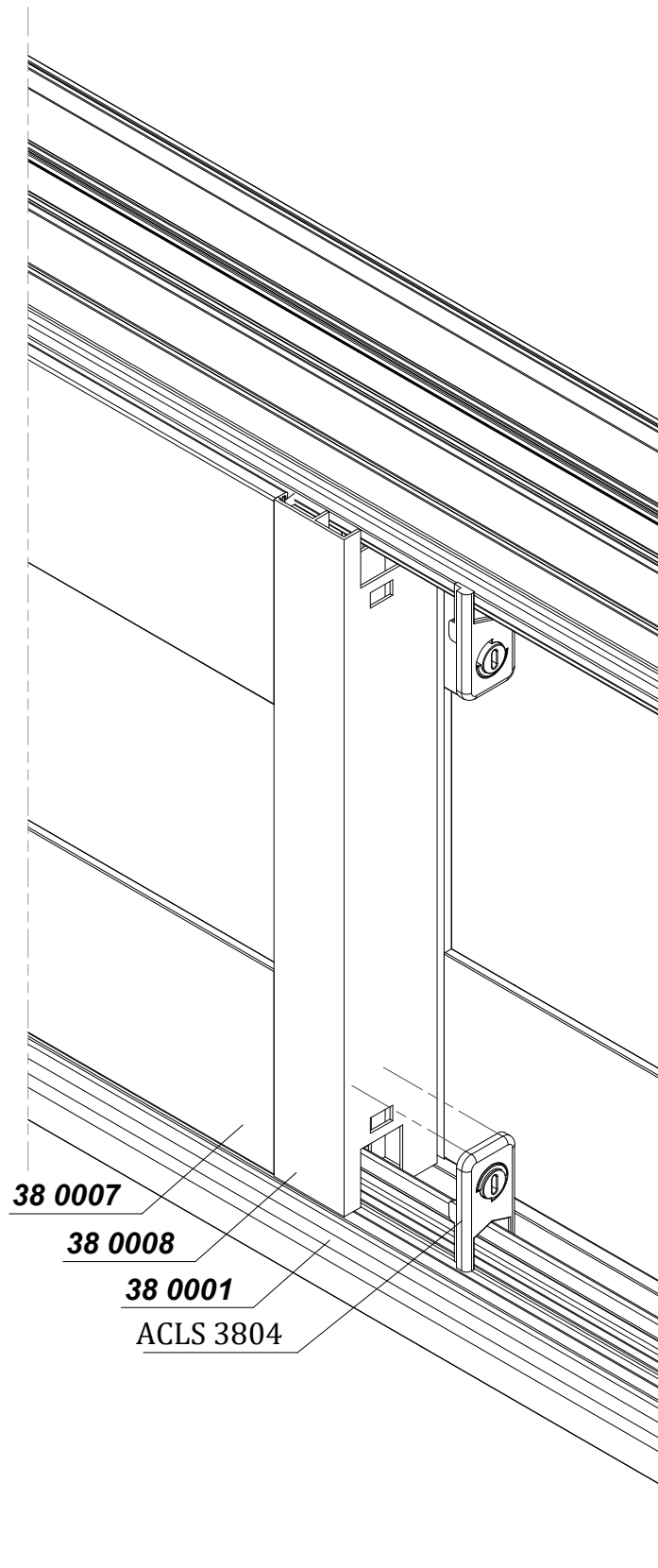

THREE DIMENSIONS DETAILS

Cutting dimensions of 38 0008

First stage

Second stage

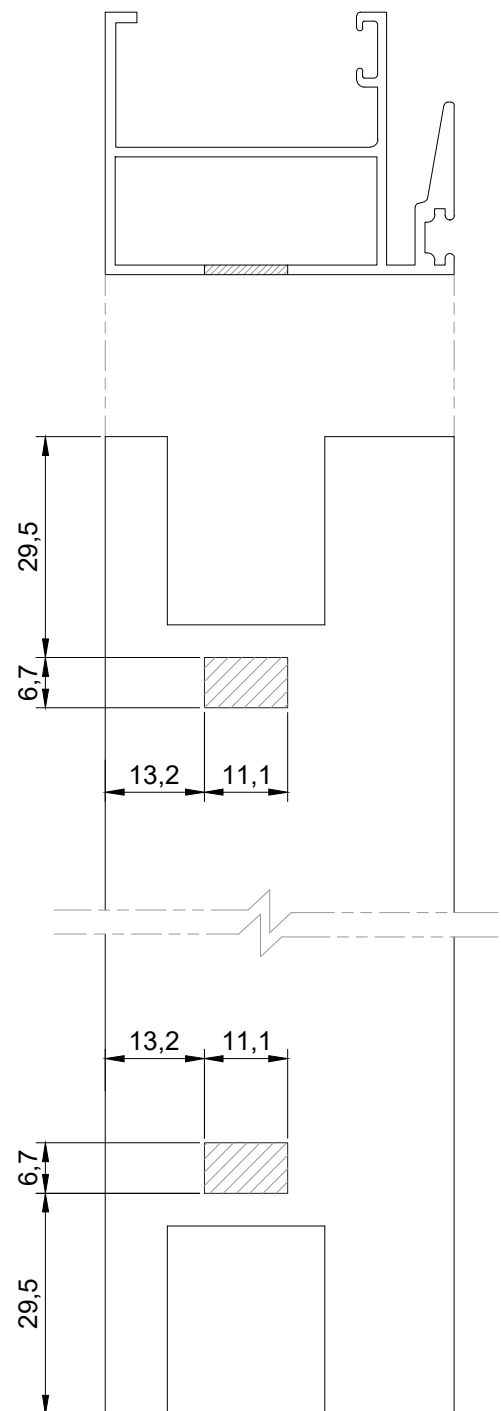
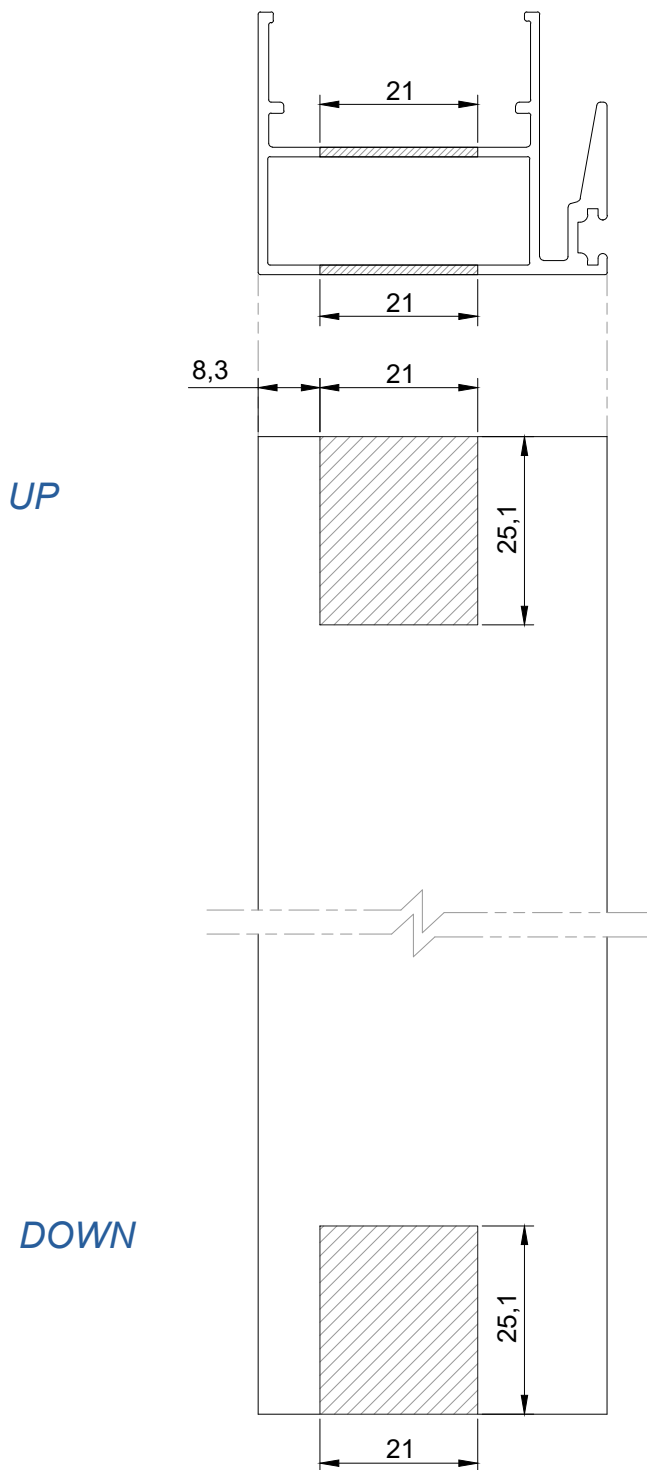

Cutting dimensions of 38 0013

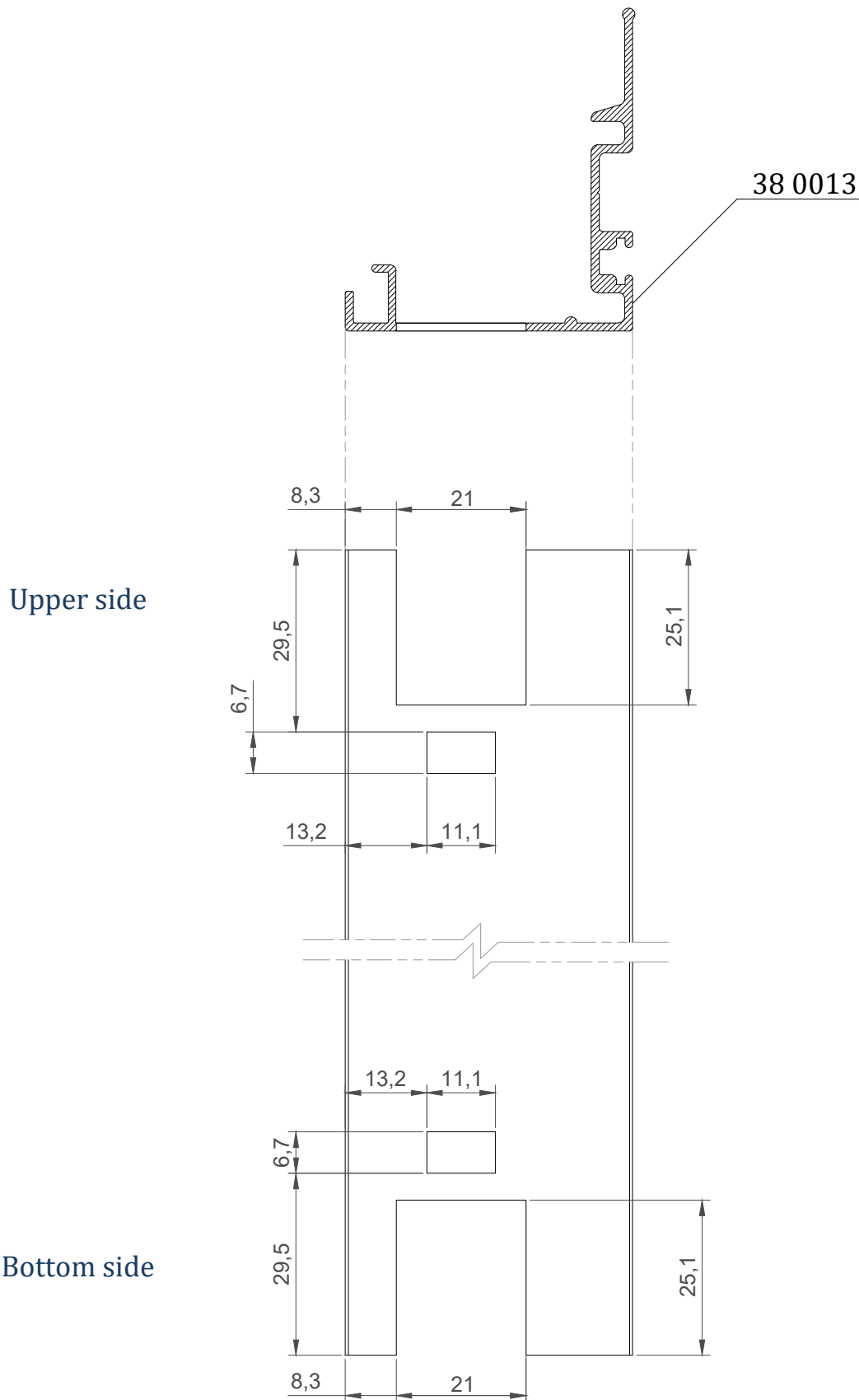

Hook profile and hook end cap assembly.

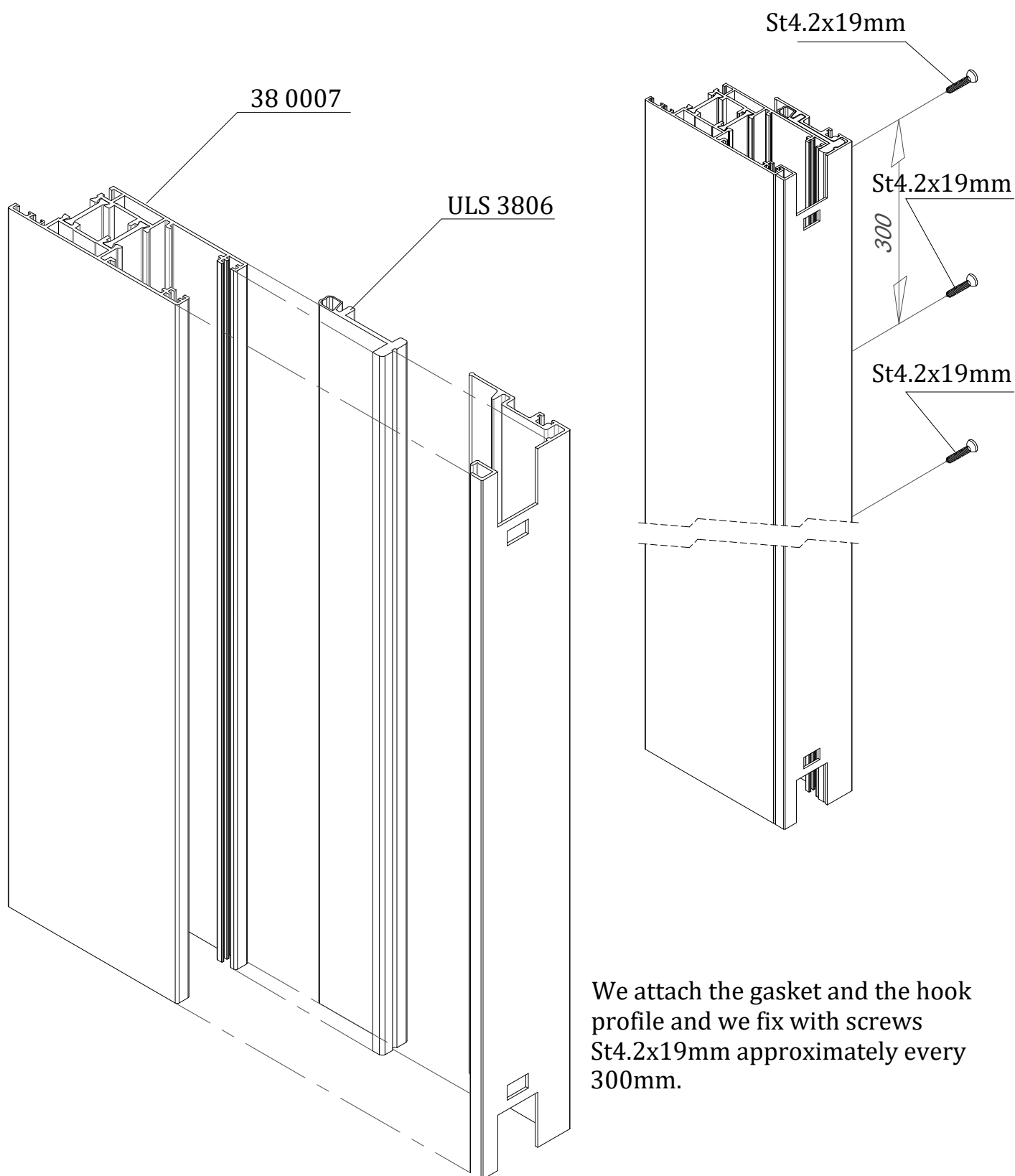

We attach the gasket and the hook profile and we fix with screws St4.2x19mm approximately every 300mm.

Hook profile and hook end cap assembly.

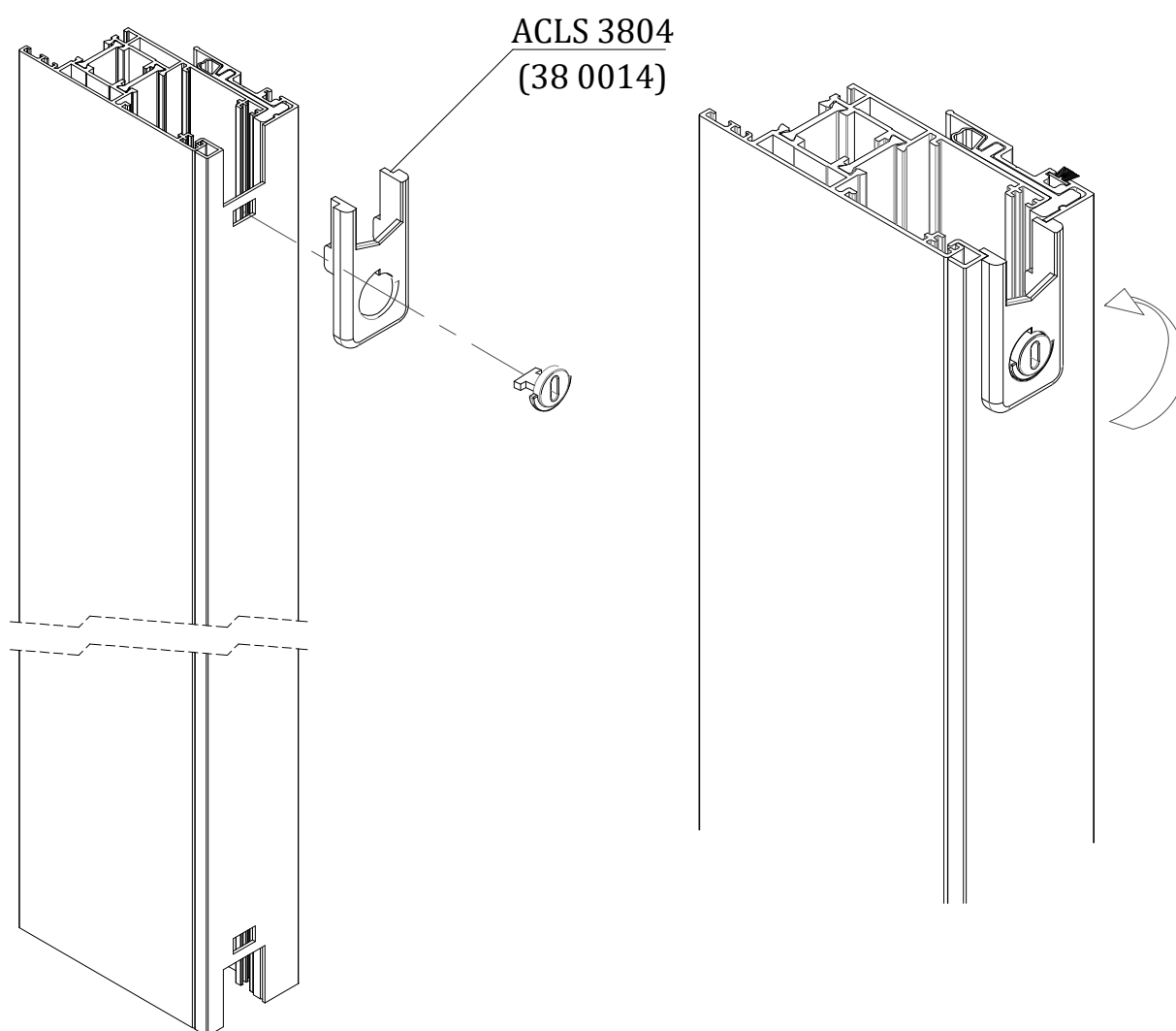

In order to mount the end cap on the sash, we place it as shown below and we insert the plastic rounded cap on the small rectangular hole. After this we use a screw bit to rotate it clockwise 90 degrees. The end cap is now secured.
We follow the same procedure for Lift & Slide frames.

Sash assembly with mullion profile

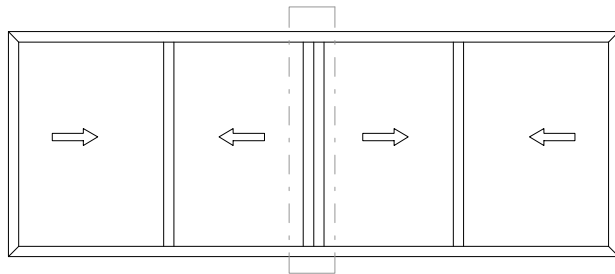

STEP 1

- We insert the pre-drilled structural section in the sash profile.
- We fix it in place using screws St 4.2x22mm. The maximum distance between those accessories could be no more than 400mm.

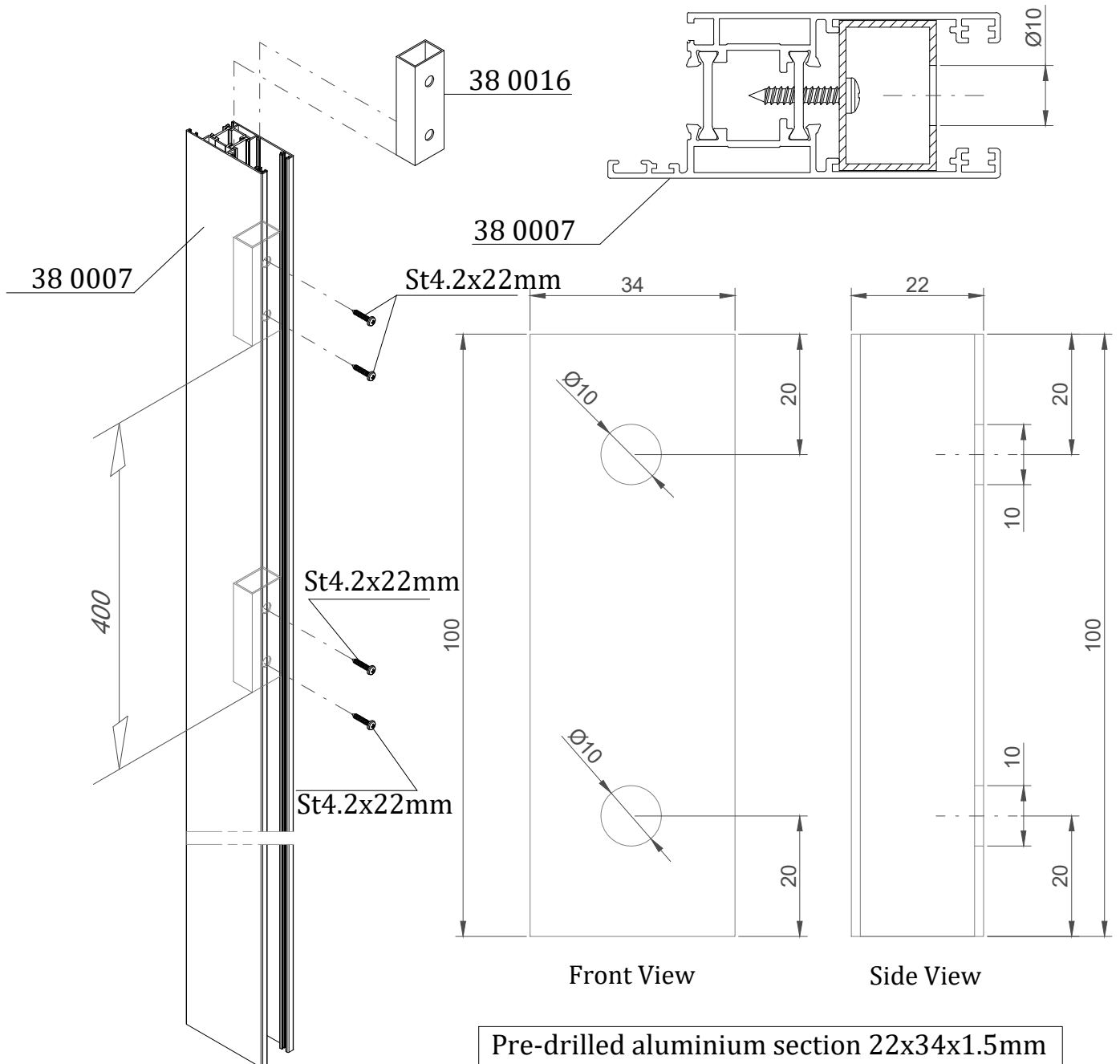

Pre-drilled aluminium section 22x34x1.5mm

Sash assembly with mullion profile

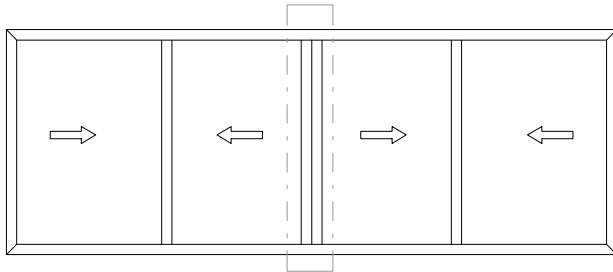

STEP 2

We pre-drill with a 10mm drill bit the mullion profile 38 0010 and we attach the gasket on it. We screw the mullion through the pre-drilled holes on the sash as shown below. We have in mind, not to mate the pre-drilled holes.

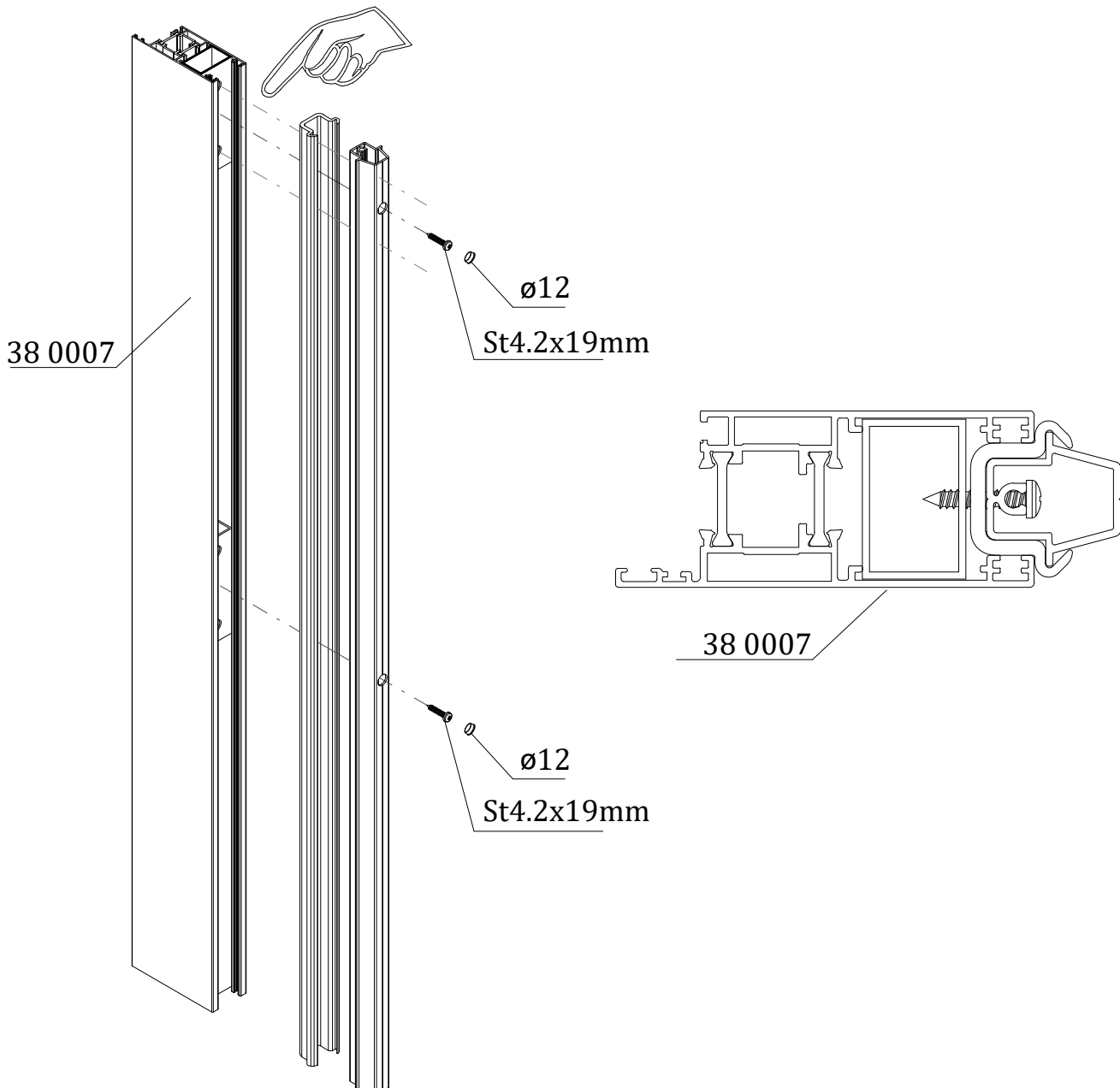

*Meeting stile profile
cap assembly*

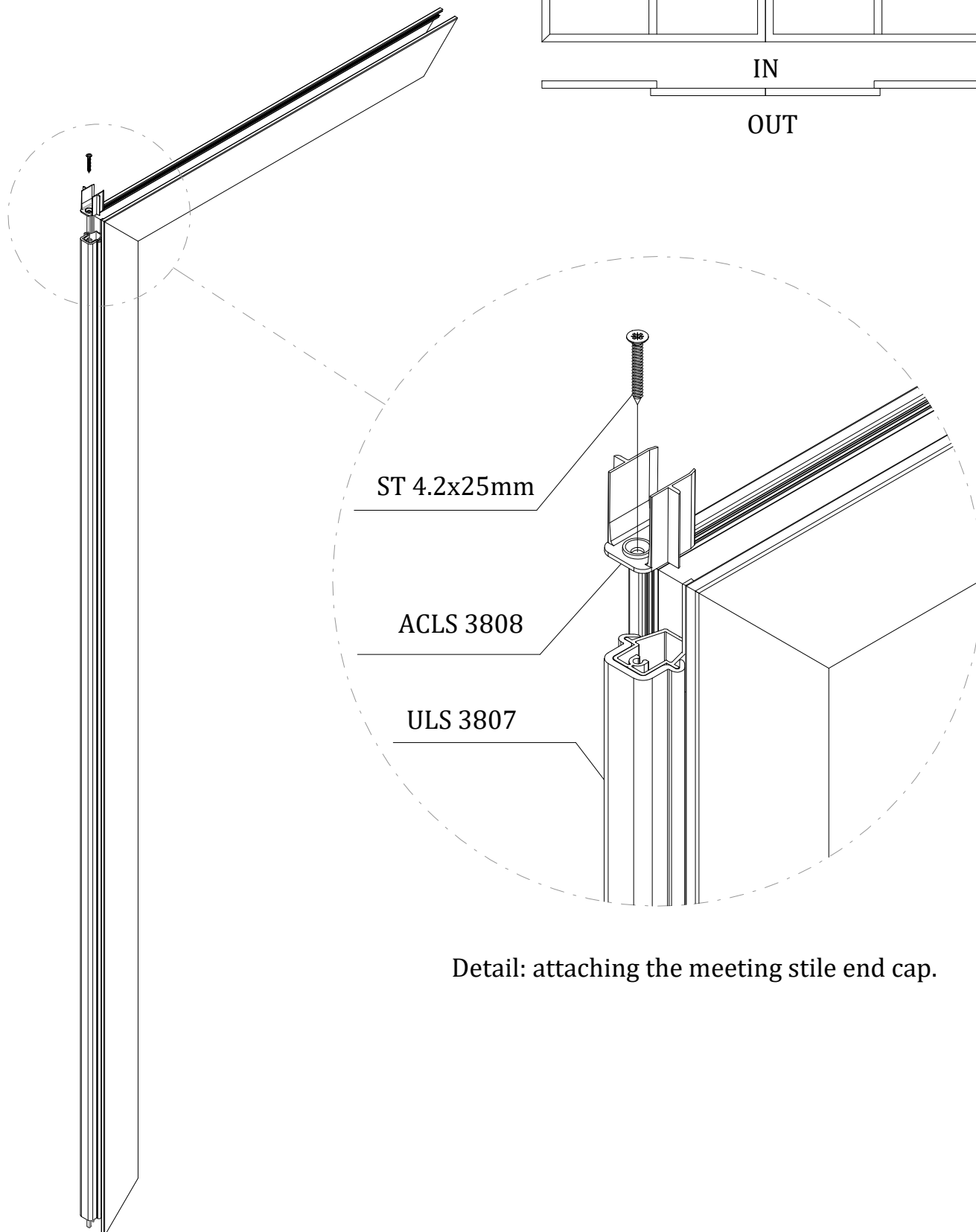
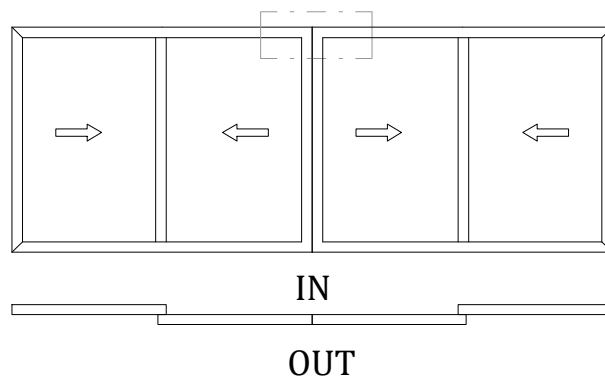

Detail: attaching the meeting stile end cap.

Installation roller

STEP 1

We attach the rollers at the bottom of the sash before we assemble the sash.

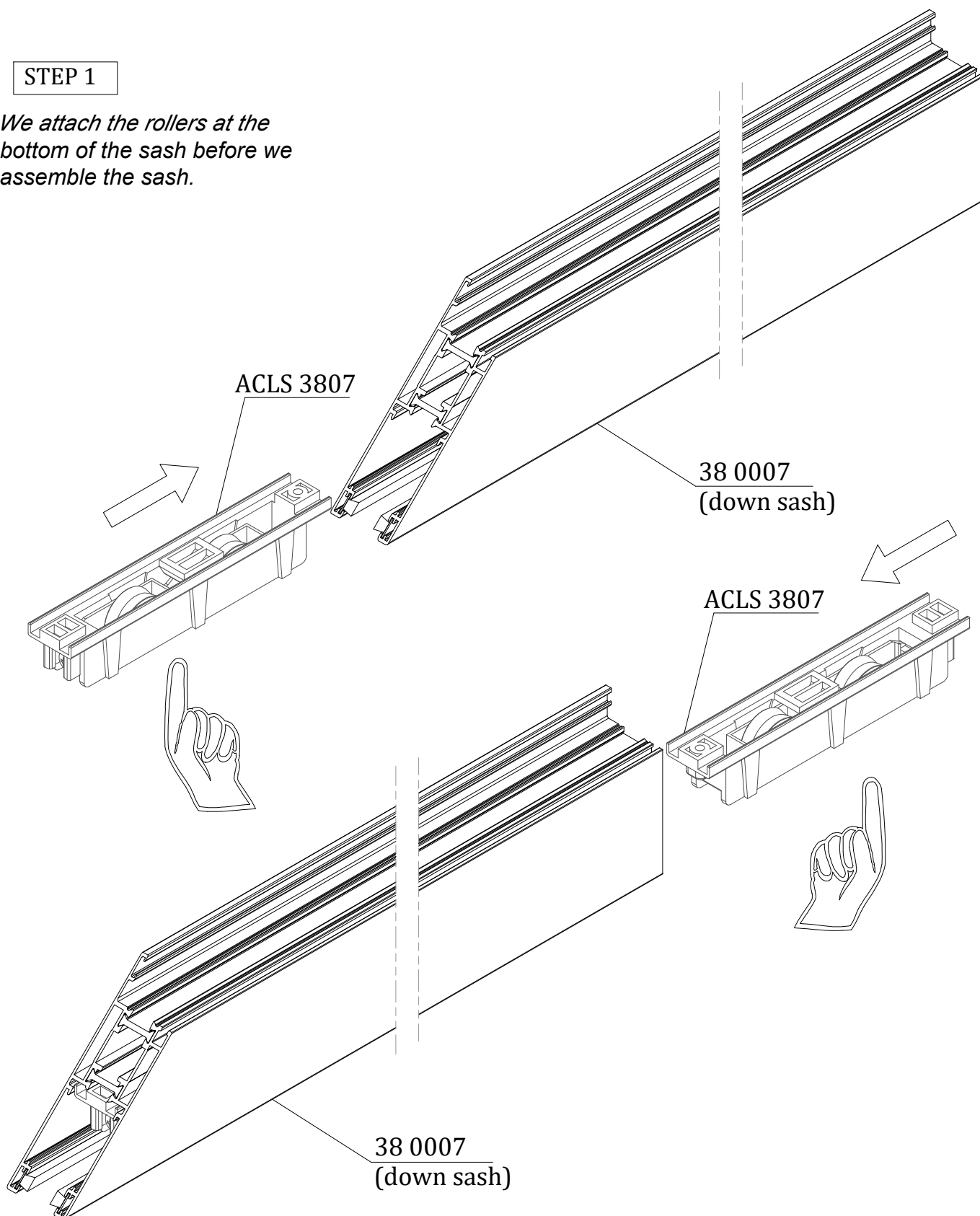

Installation roller

STEP 2

Step 2 follows after the assembly of the sash as shown before.

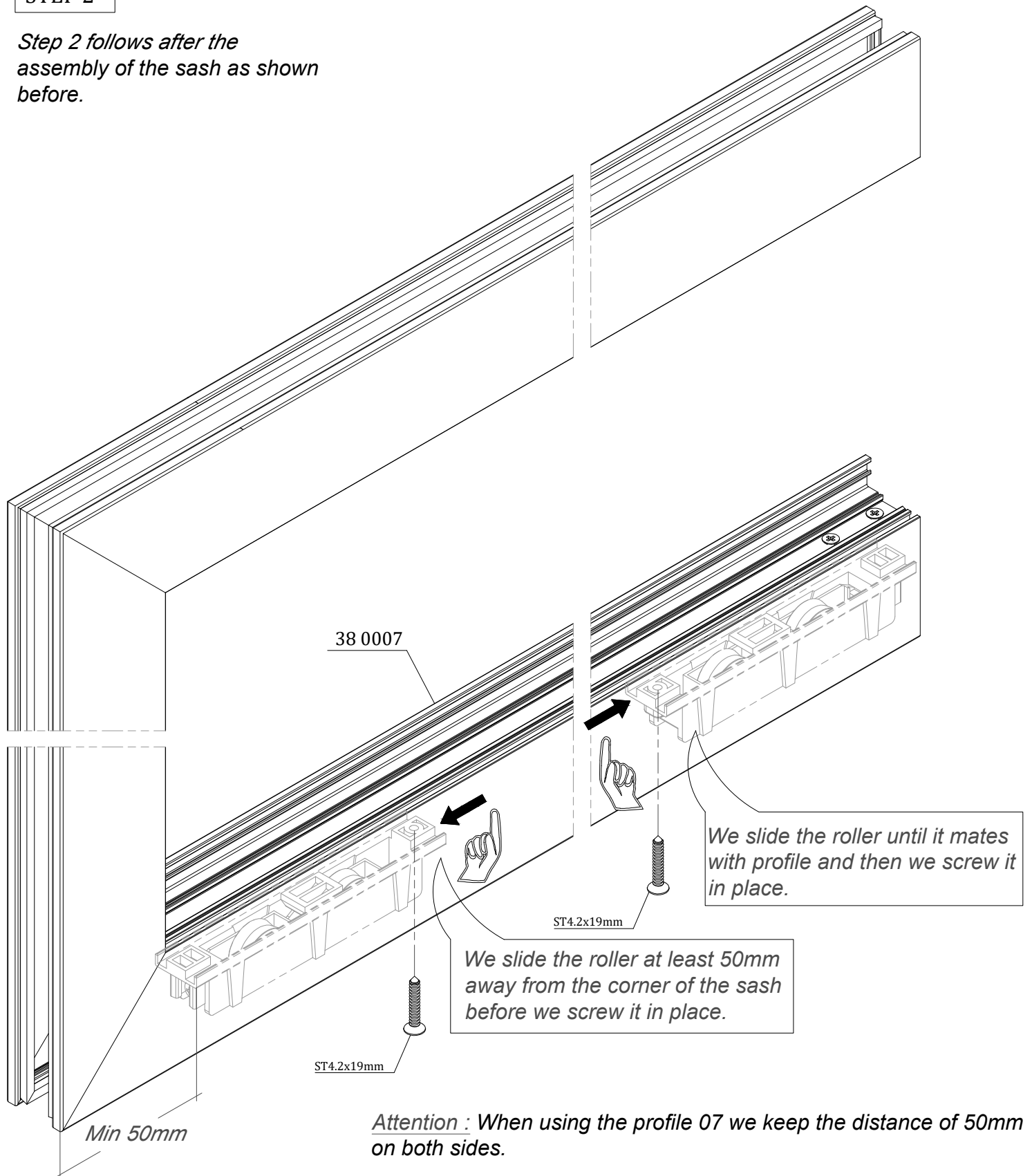

Installation bumper

STEP 1

We slide on vertical members of the sash the sock absorber as shown.

Attention : We screw the bolt until its final position, before we slide it on the sash as per previous note.

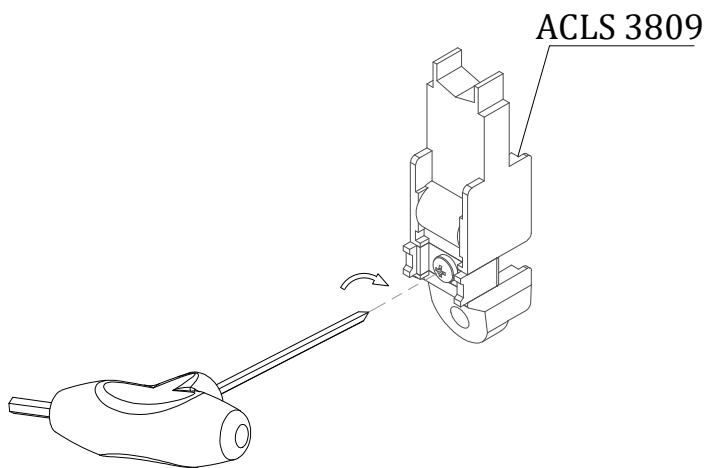
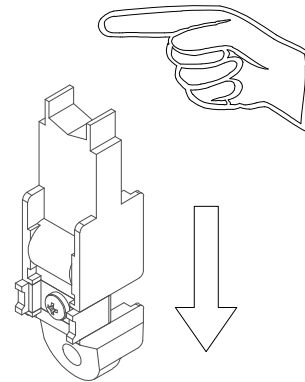

ACLS 3809

38 0007
(side sash)

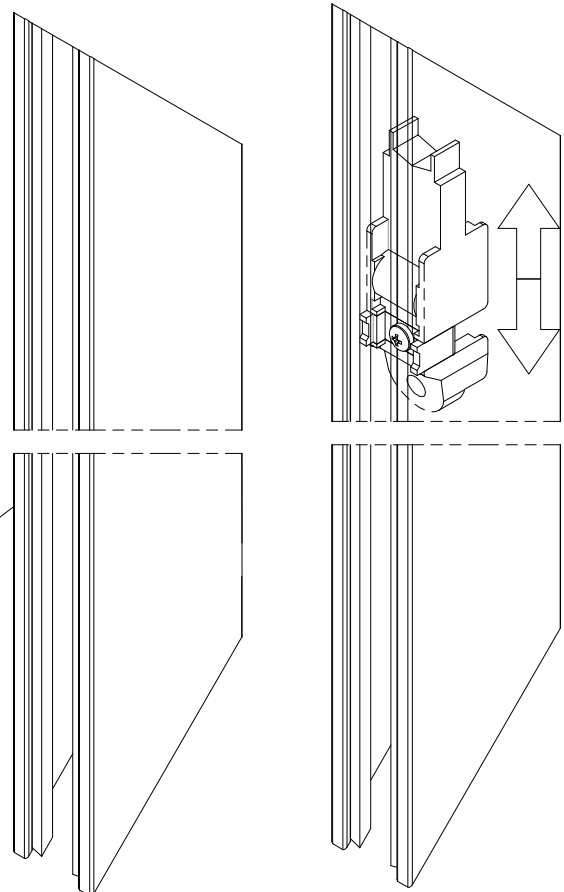

TOP VIEW

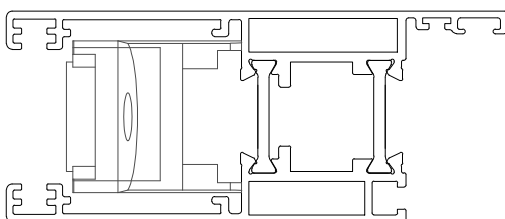

Installation bumper

STEP 2

After we load the sash on the frame, we unscrew the bolt in order to fix the sock absorber on its final position.

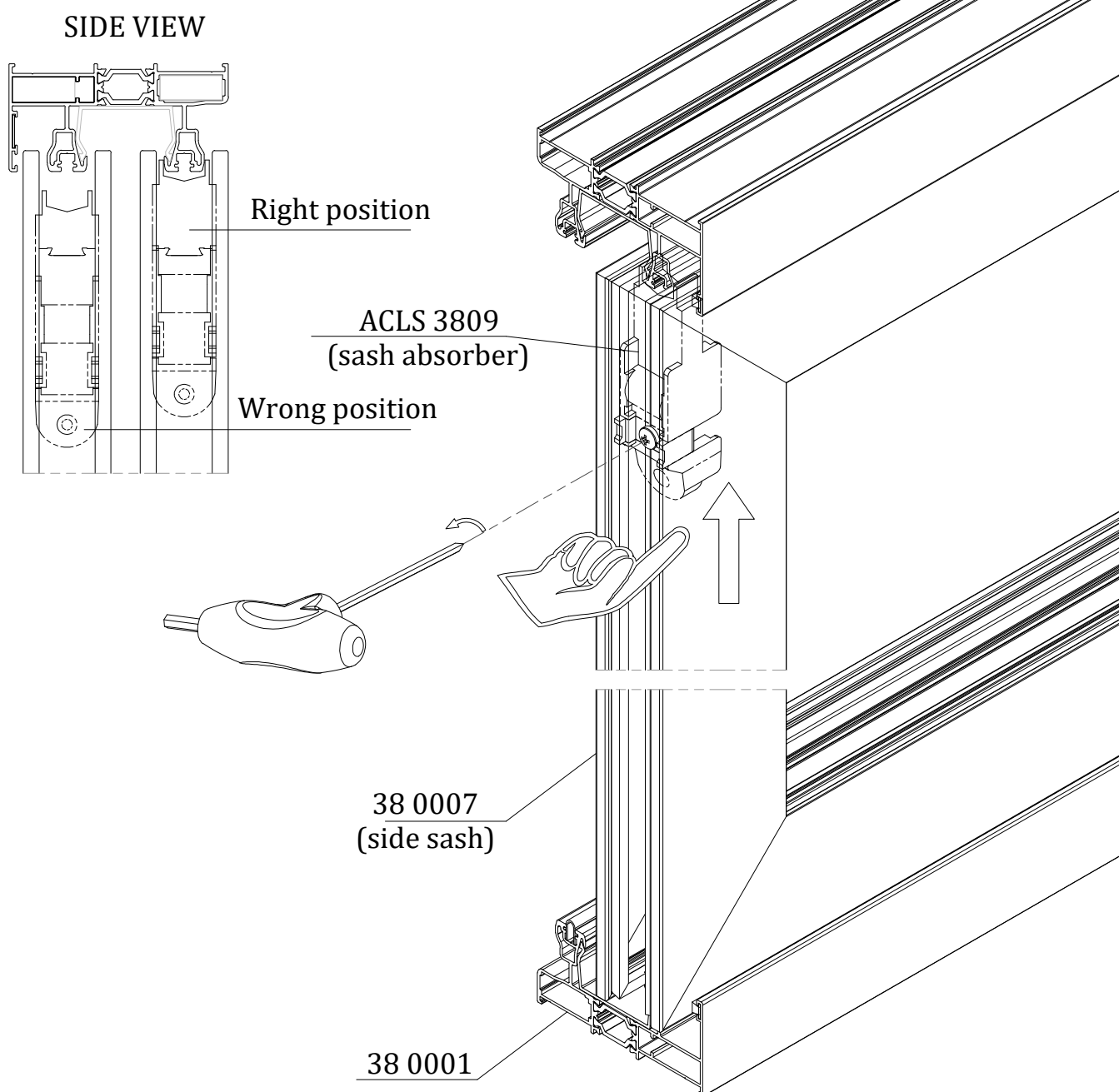

Lock assembly In-line(GU)

STEP 1

We attach the plastic spacer (GUL14-H-11140-38-0-6) on the lock before we screw it on the sash.

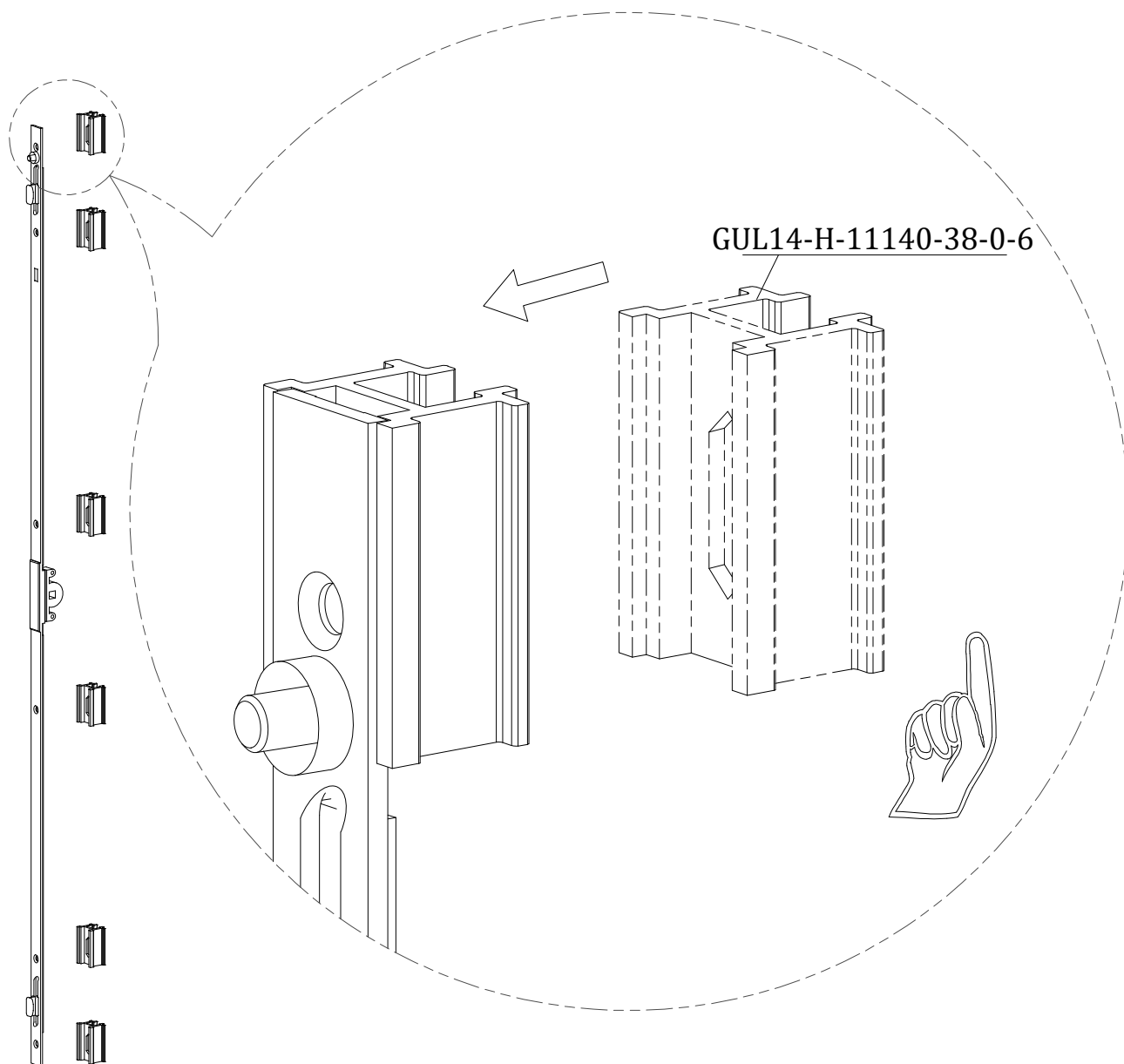

Lock assembly In-line(GU)

STEP 2

We screw the lock assembly according to machining of the sash.

GUL14-H-11140-38-0-6

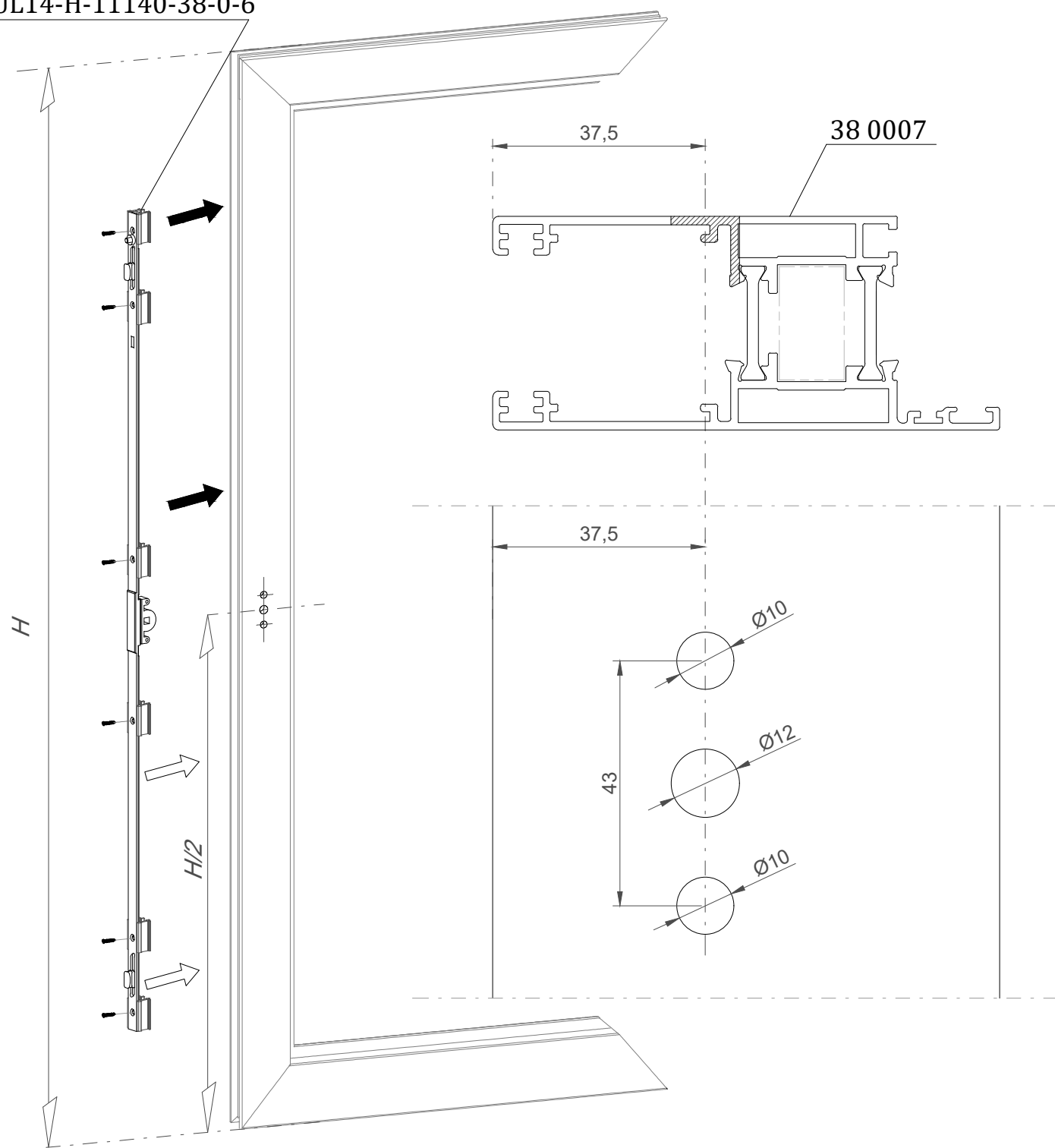

Subframe assembly

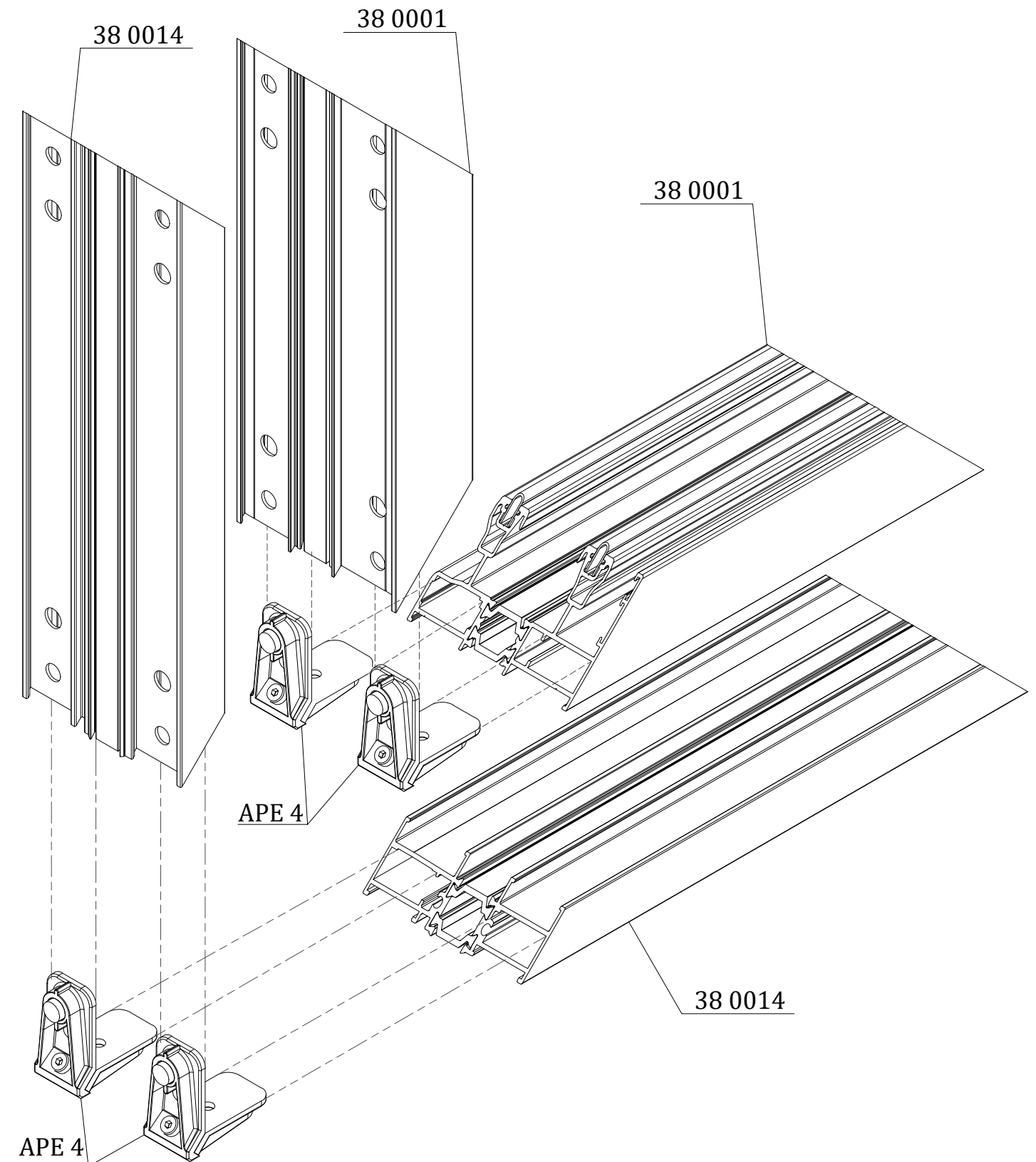

Subframe assembly

We can attach the frame on the subframe and fix with screws approximately every 300mm.

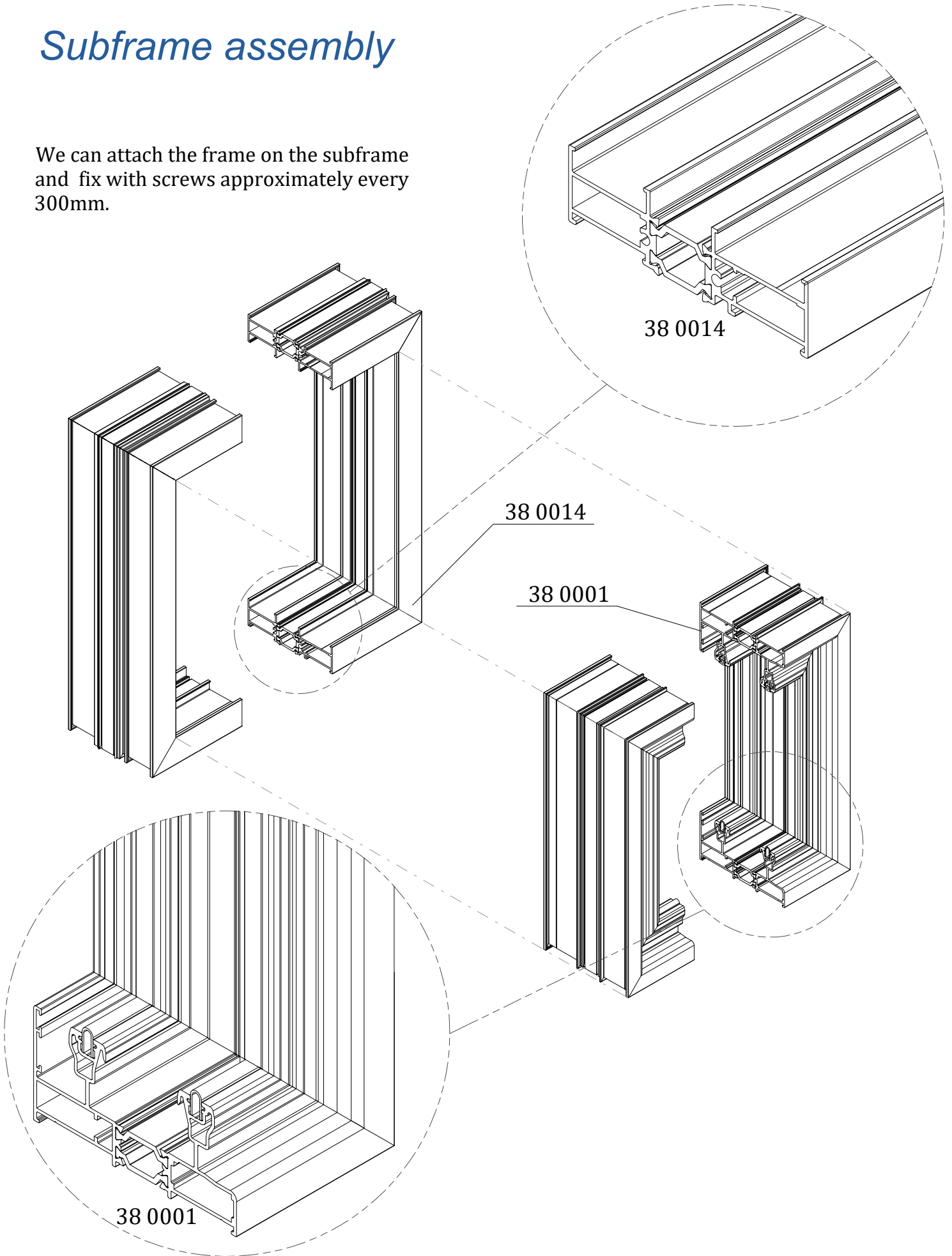

Subframe assembly

Alternatively when using ACLS 3805 only on the bottom side of frame, we should use end cap on both sides.

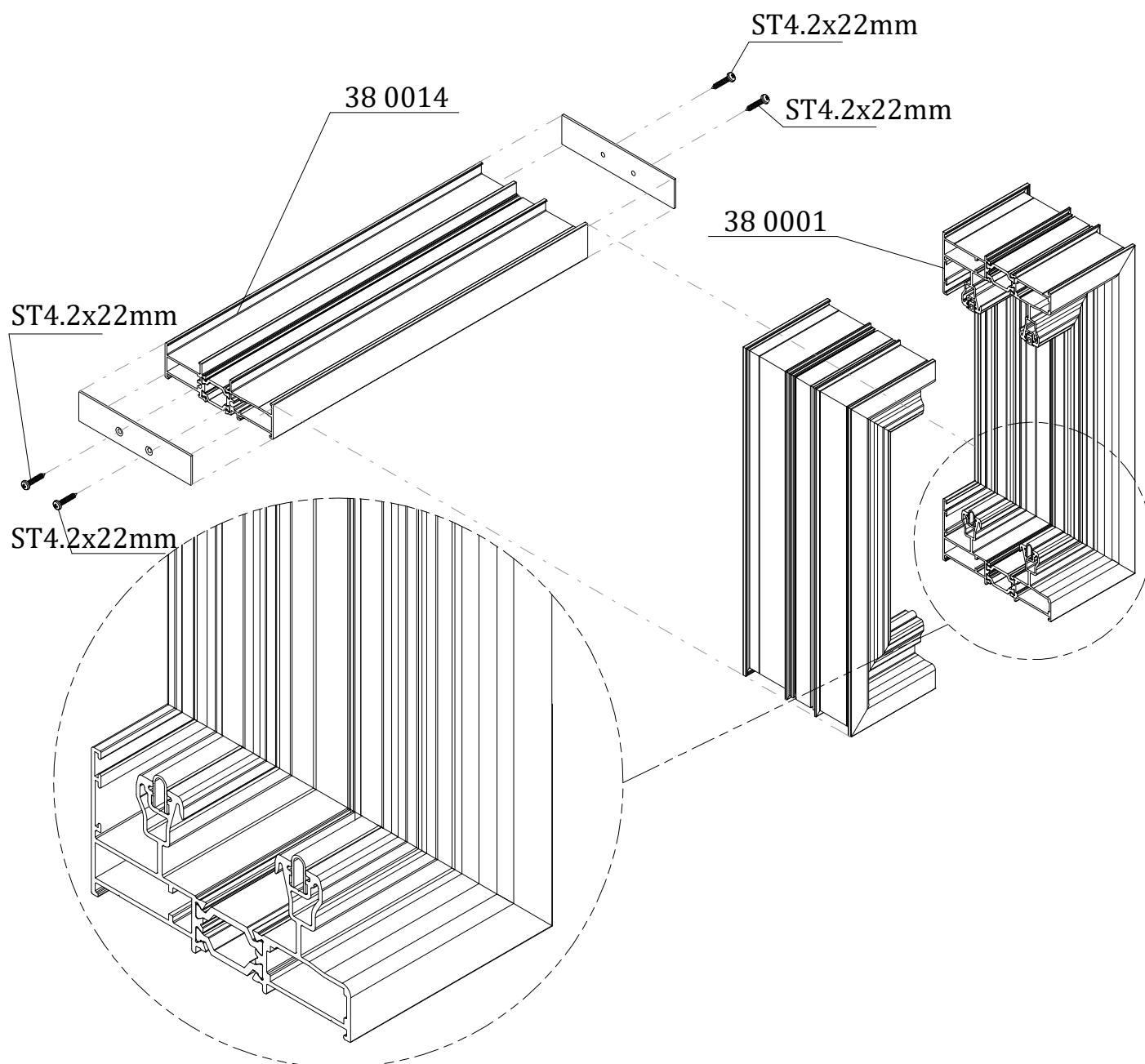

***LIFT & SLIDE 38
SYSTEM***

***THREE DIMENSIONS
DETAILS***



*Double rail frame connection
with threshold profile*

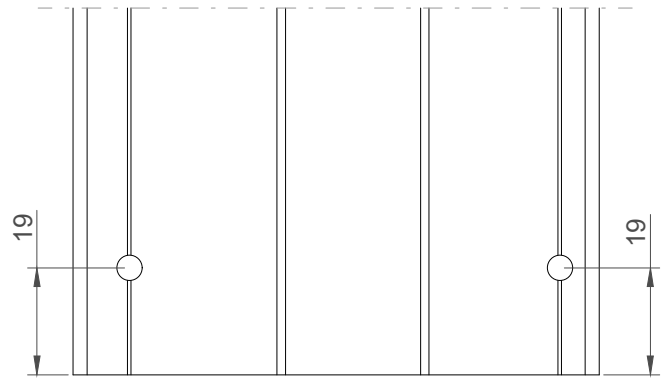
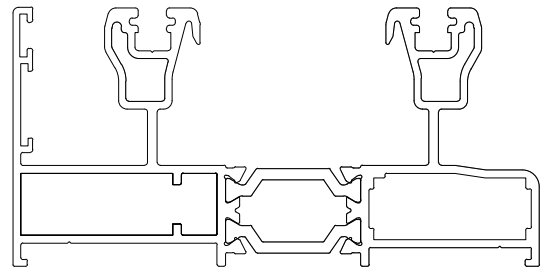
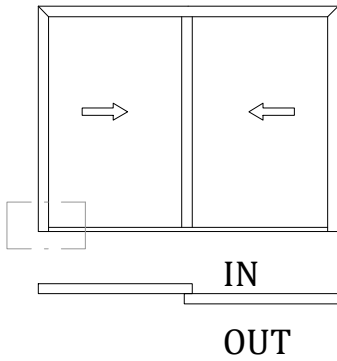

Drilling dimensions 38 0001

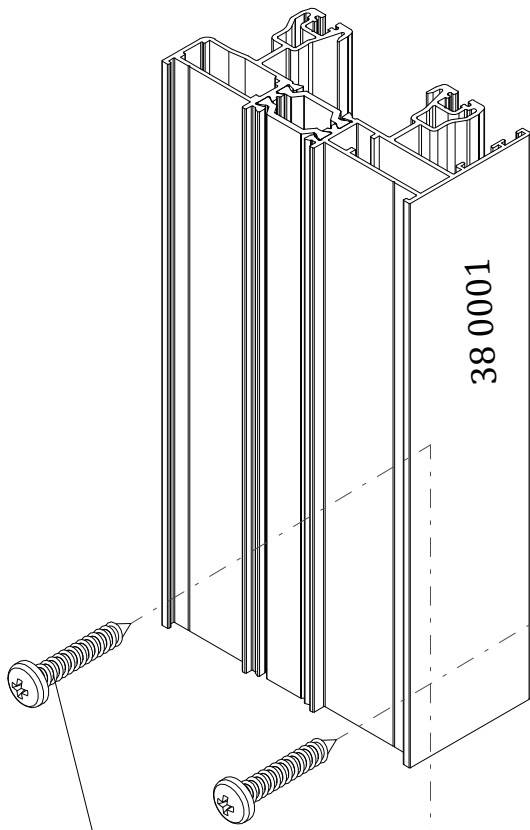

2x ST4.2x25mm

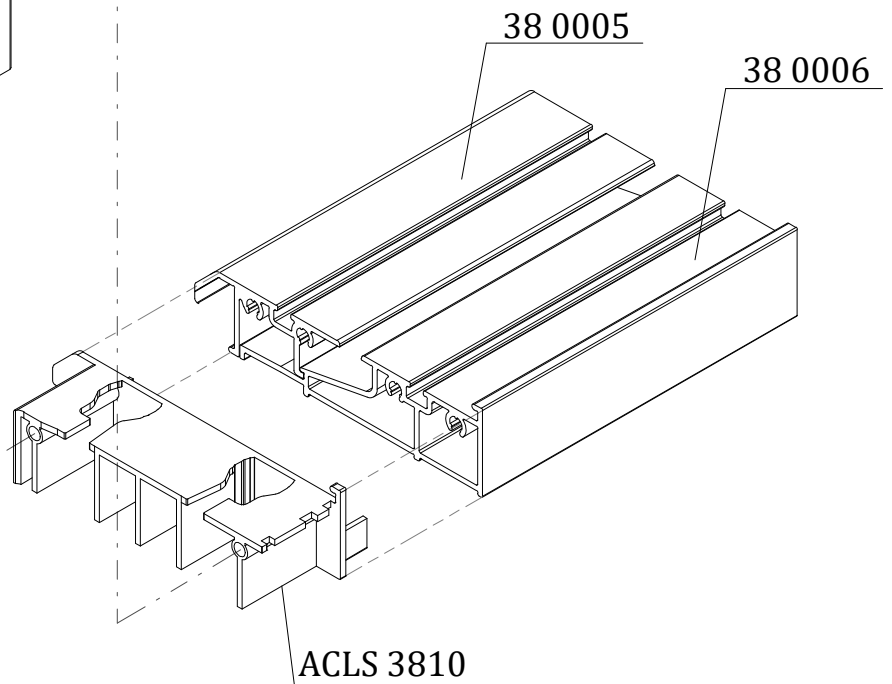

ACLS 3810

*Double rail frame connection
with threshold profile*

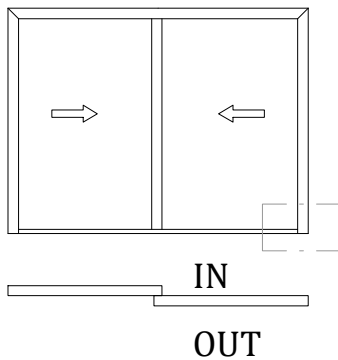

We apply silicone to highlighted edges

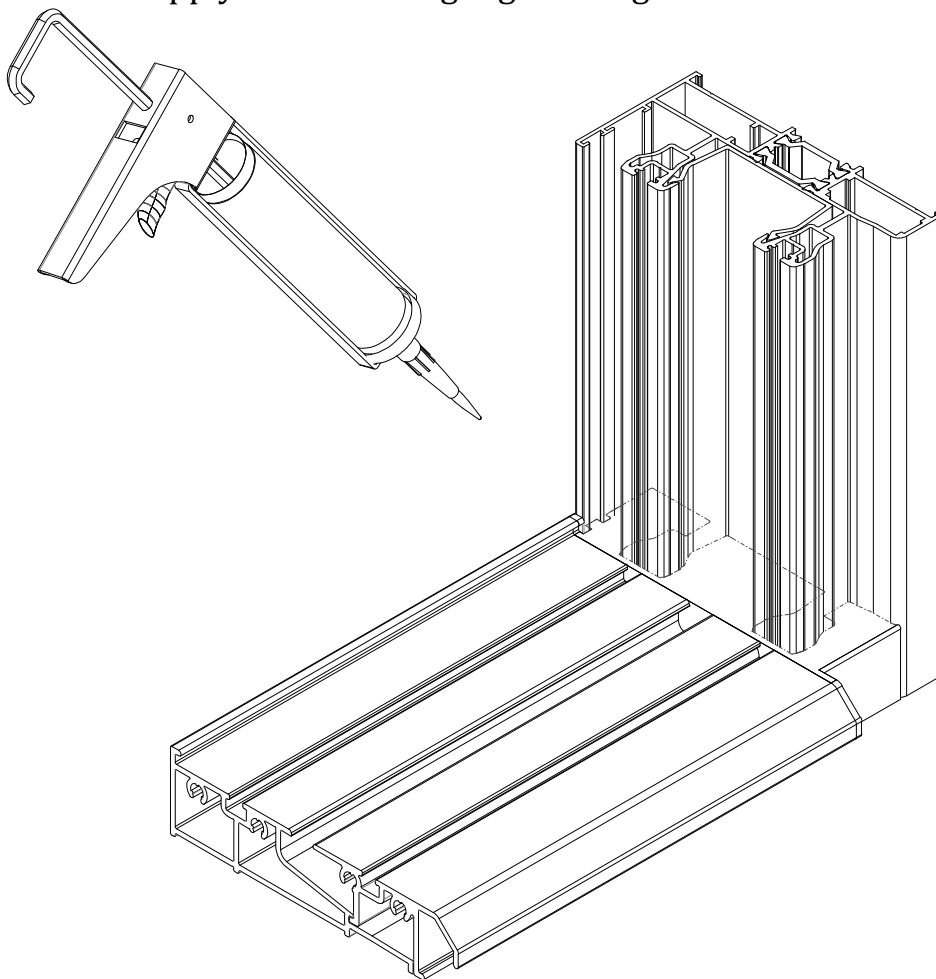

Threshold assembly

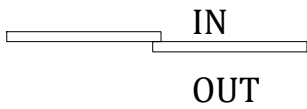
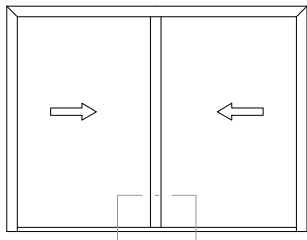

STEP 1

38 0005*

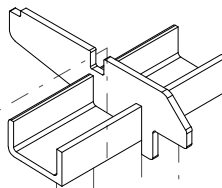
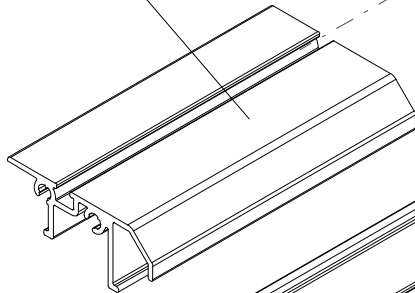

ACLS 3811

38 0006

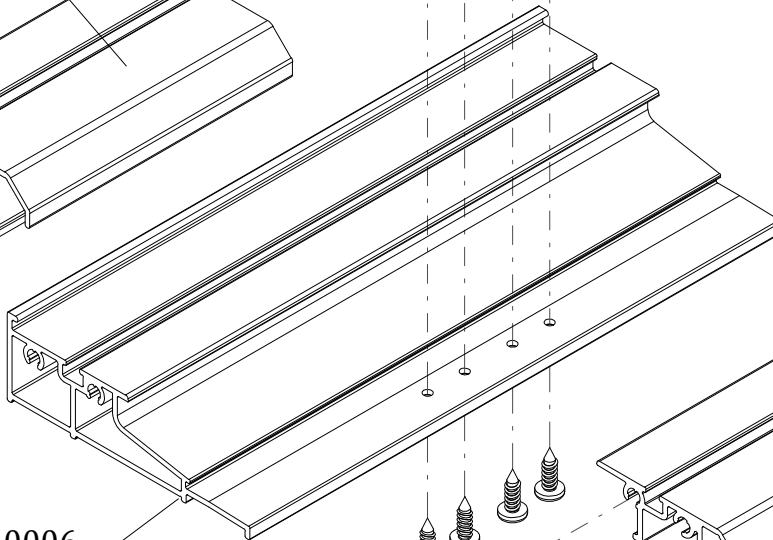

38 0005*

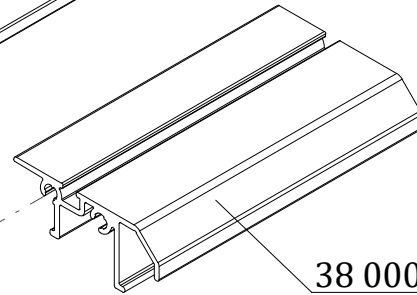

4x ST4.2x13mm

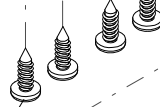

STEP 2

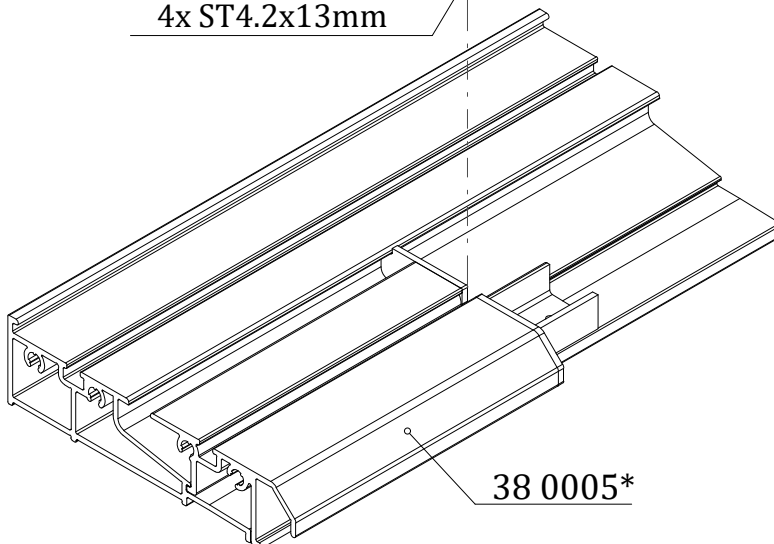

38 0005*

*Note: Milling machining for drainage holes, must be done before the final assembly

Threshold assembly

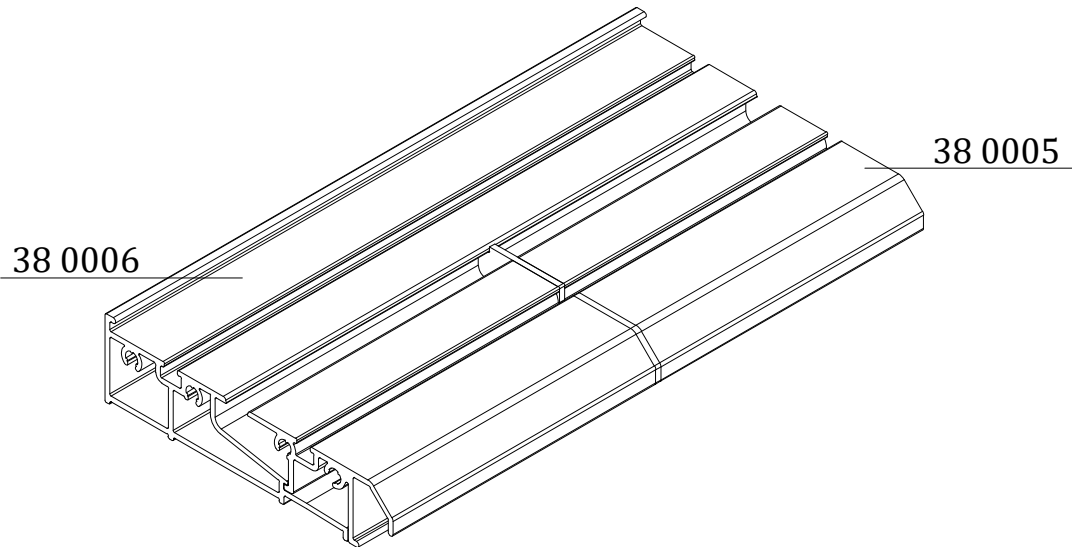

Drilling scheme for 38 0006

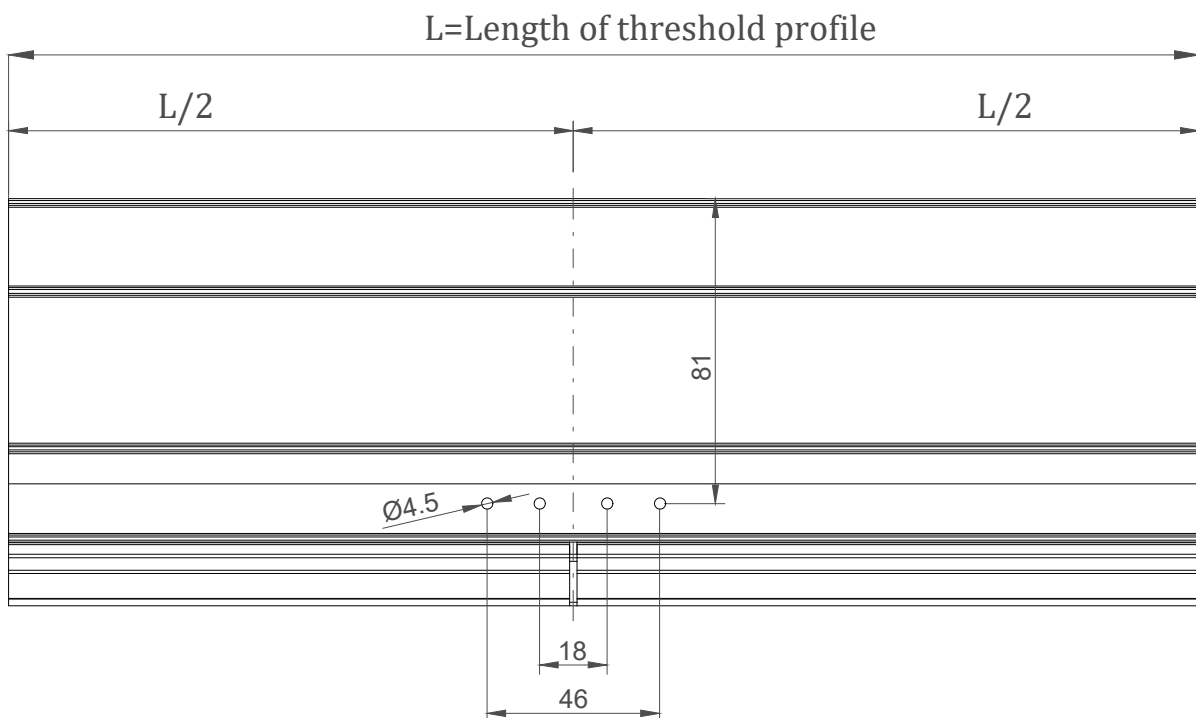

Milling scheme for water drainage in threshold profile

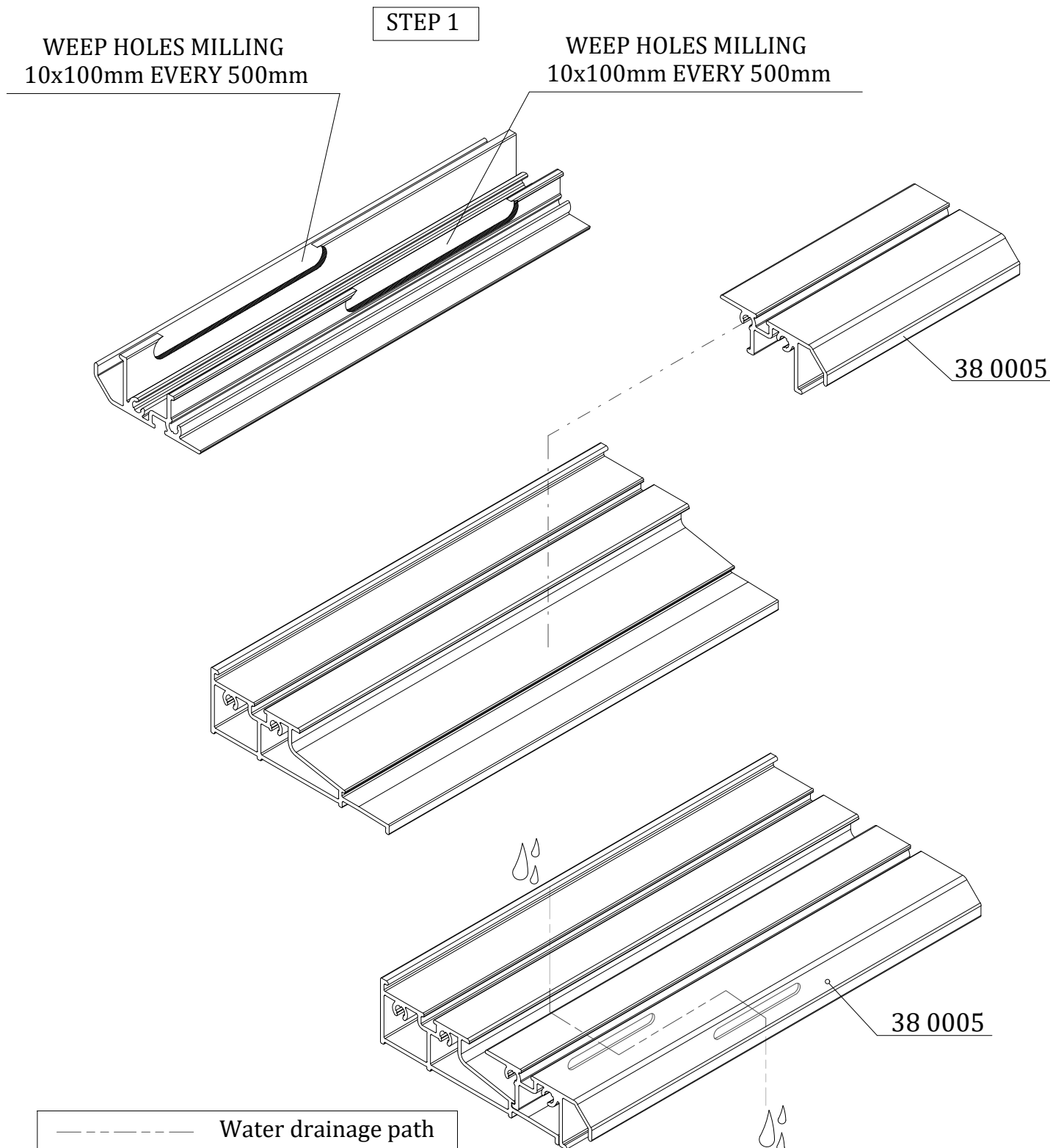

*Milling for water drainage at bottom
frame member-Double rail frame*

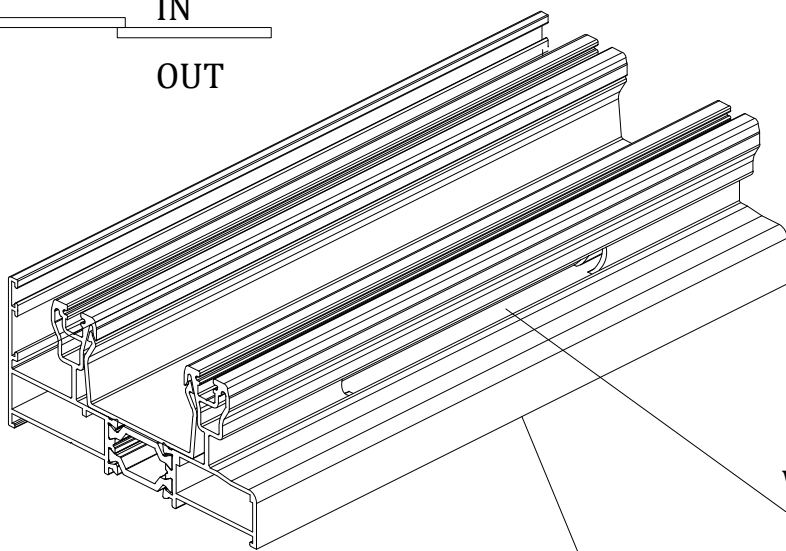
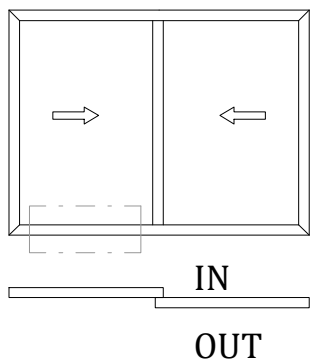

Weep hole milling 10x100mm

Weep hole milling 10X100mm

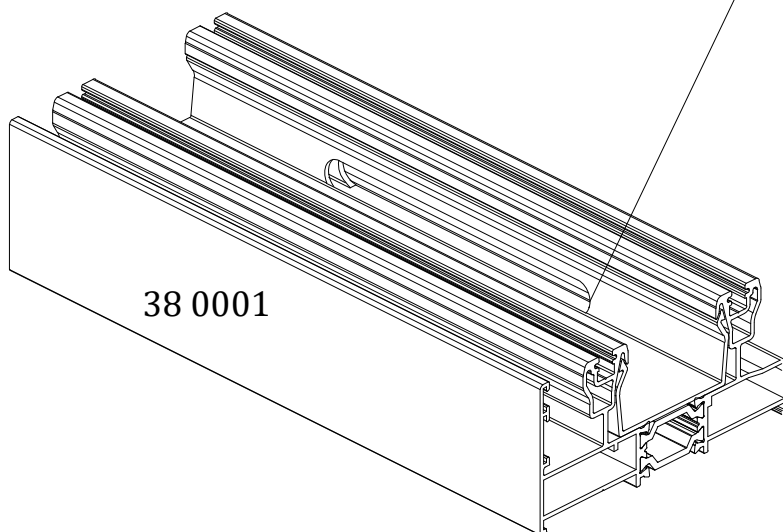

Cutting dimensions of 38 0013

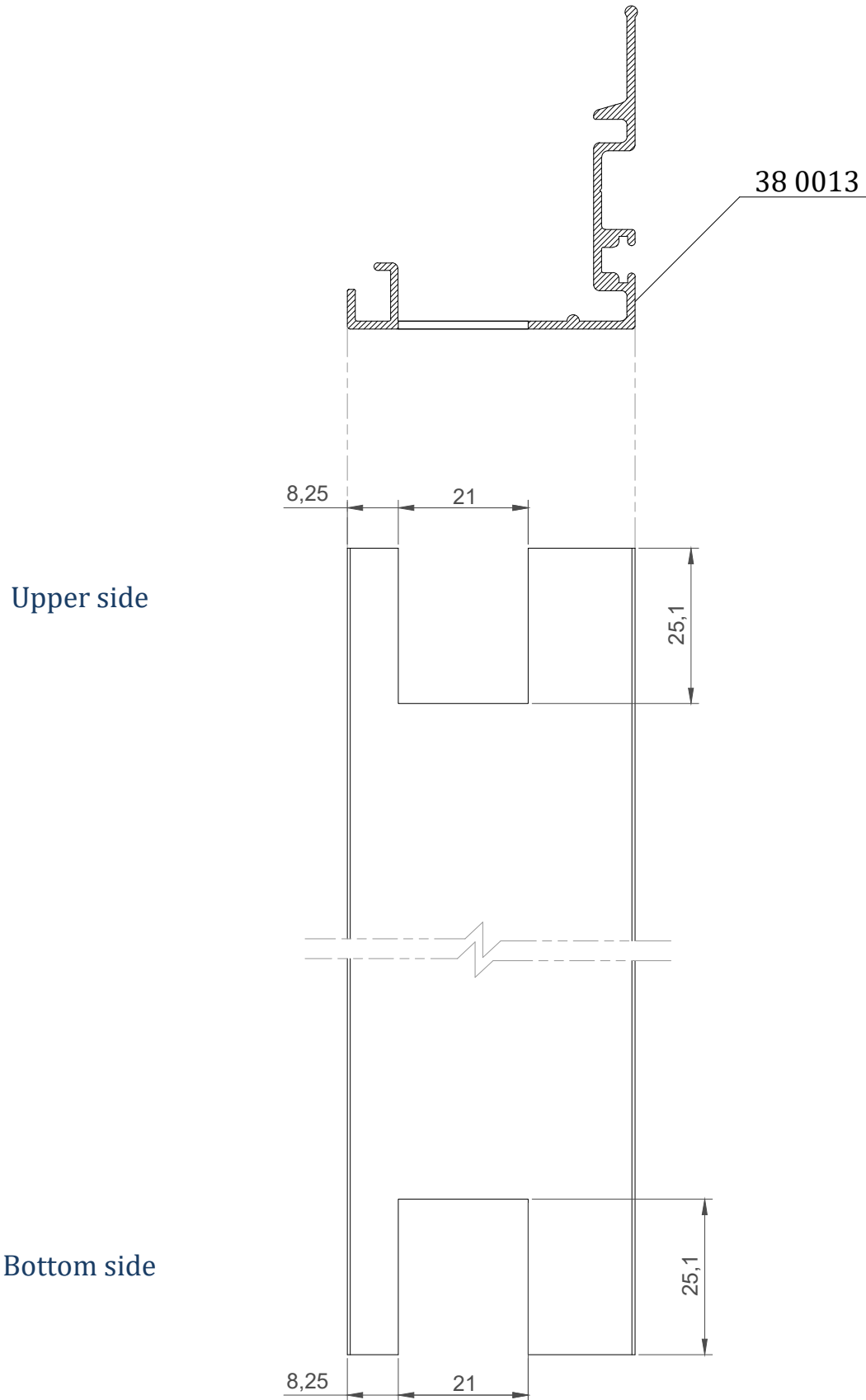

Hook profile and hook end cap assembly.

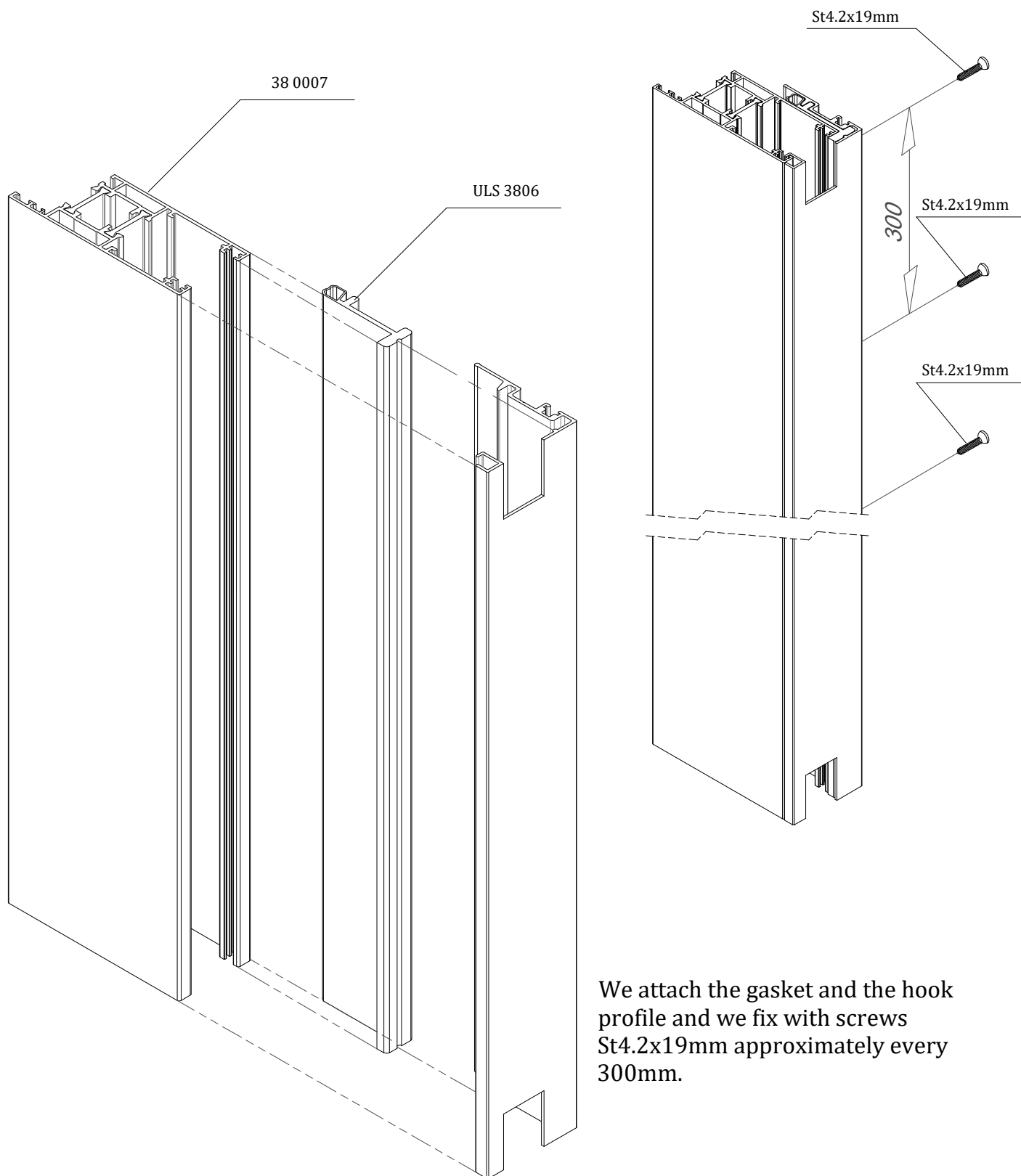

We attach the gasket and the hook profile and we fix with screws St4.2x19mm approximately every 300mm.

Hook profile and hook end cap assembly.

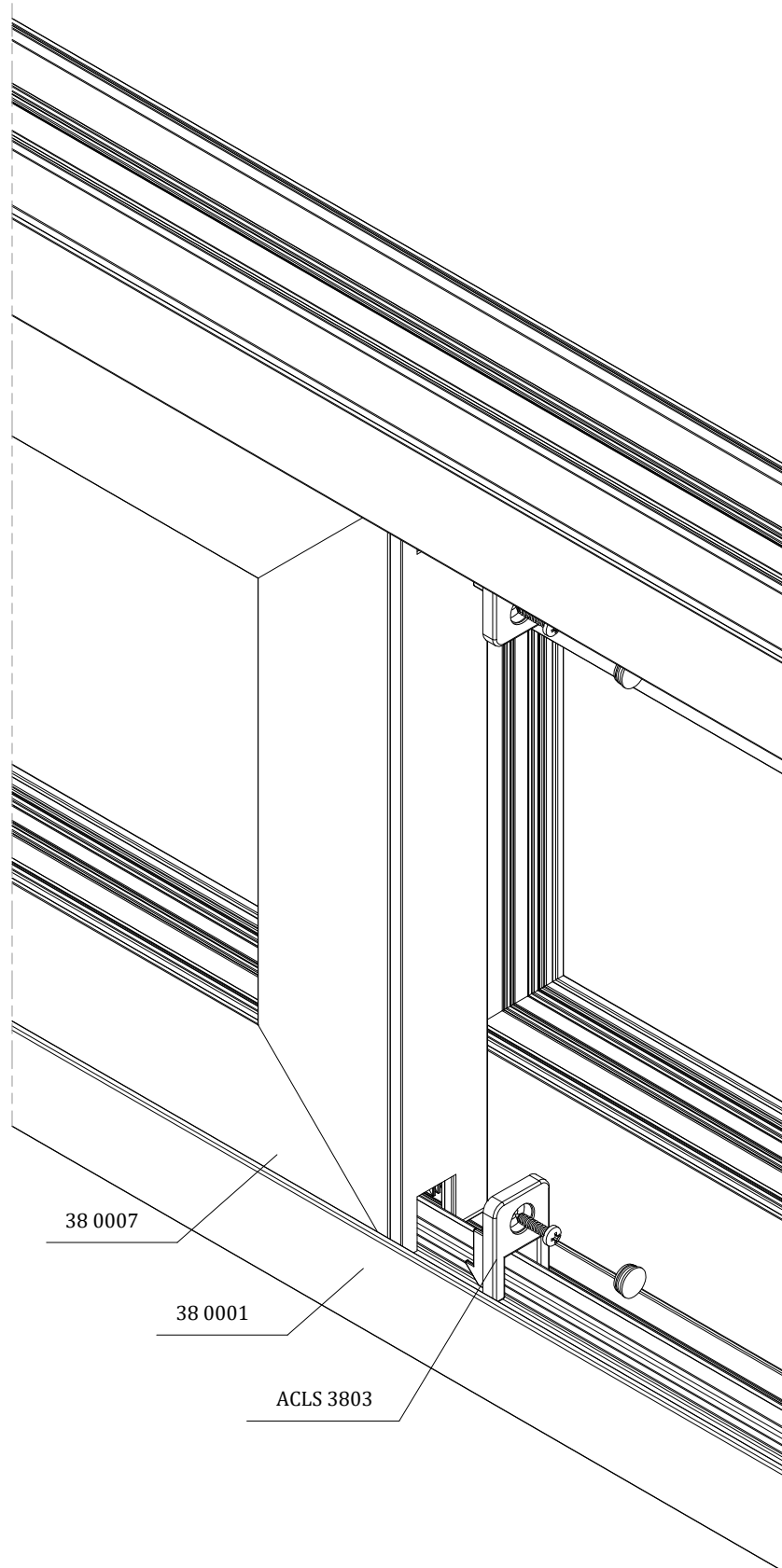

Hook profile and hook end cap assembly.

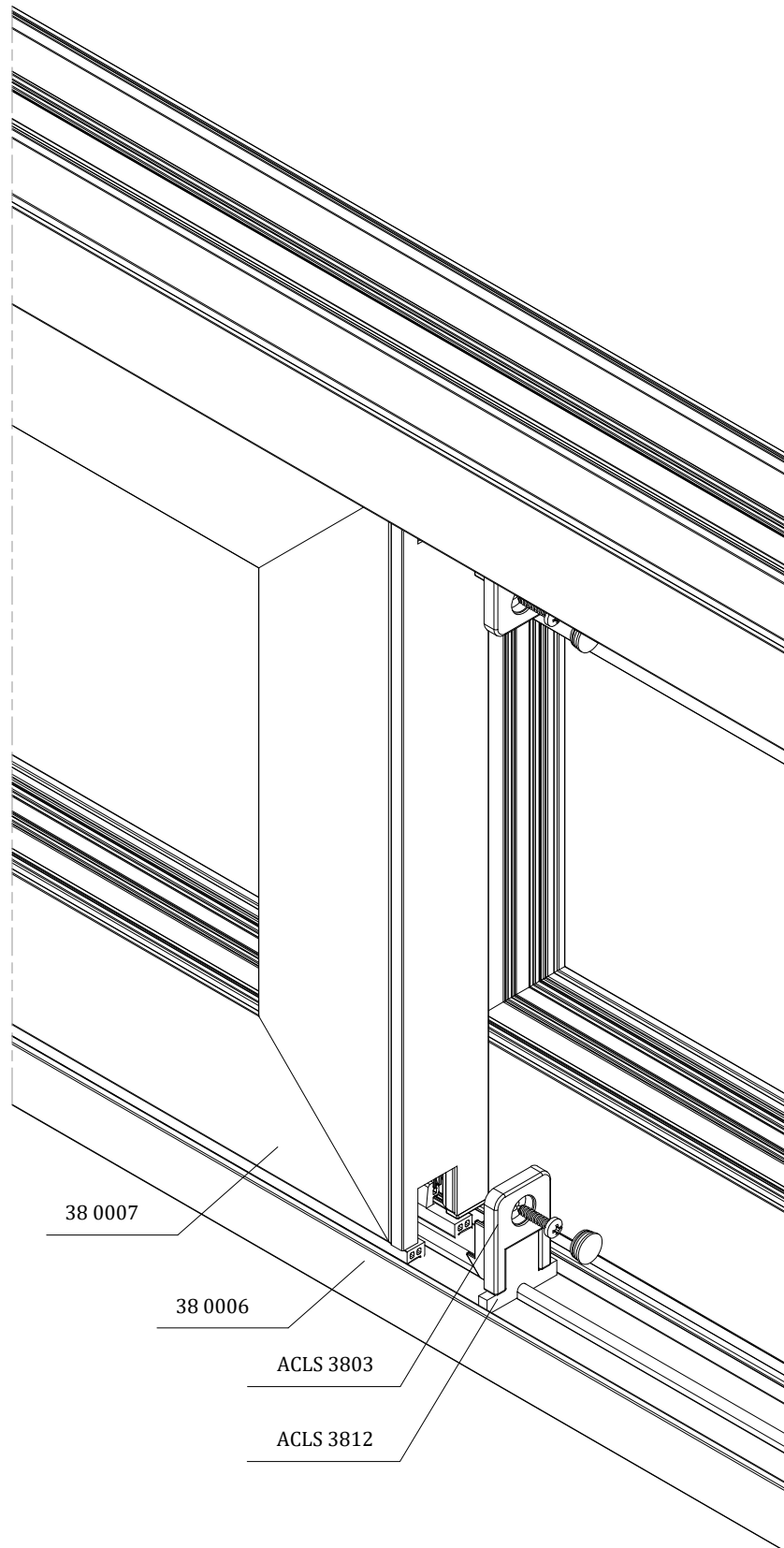

Sash assembly with mullion profile

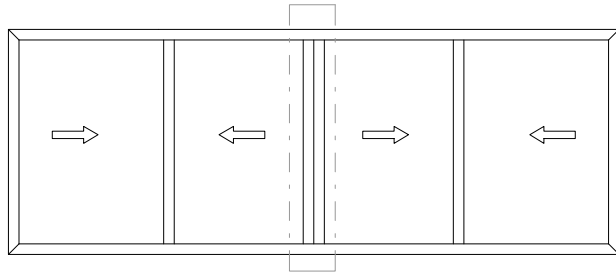

STEP 1

- We insert the pre-drilled structural section in the sash profile.
- We fix it in place using screws St 4.2x22mm. The maximum distance between those accessories could be no more than 400mm.

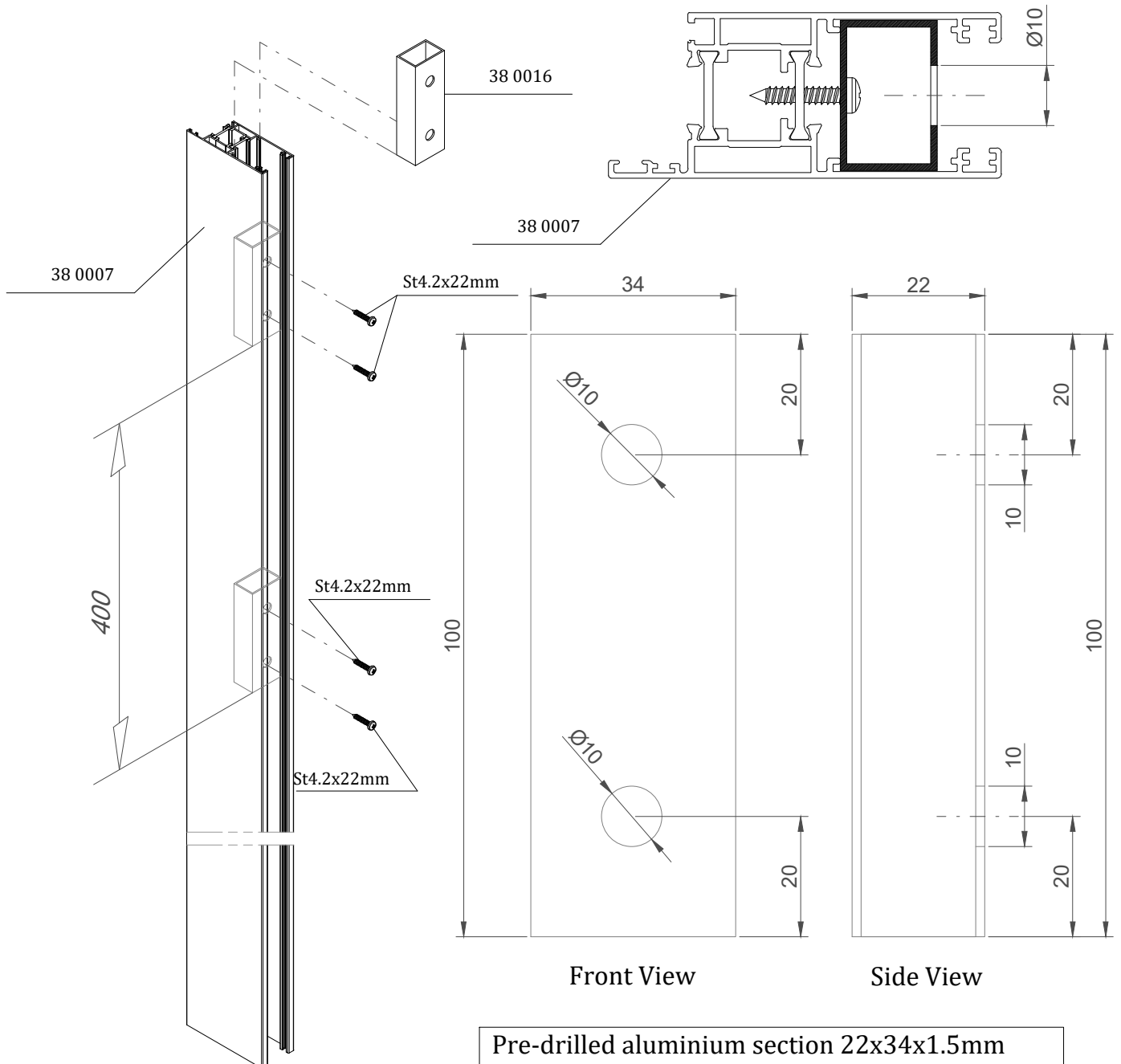

Sash assembly with mullion profile

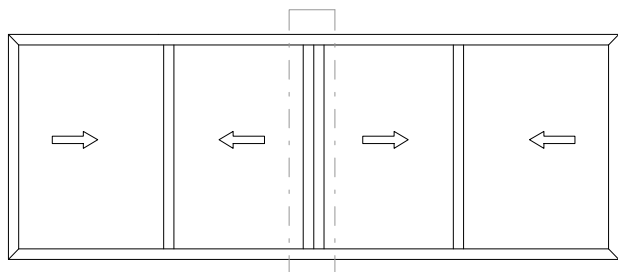

STEP 2

We pre-drill with a 10mm drill bit the mullion profile 38 0010 and we attach the gasket on it. We screw the mullion through the pre-drilled holes on the sash as shown below. We have in mind, not to mate the pre-drilled holes.

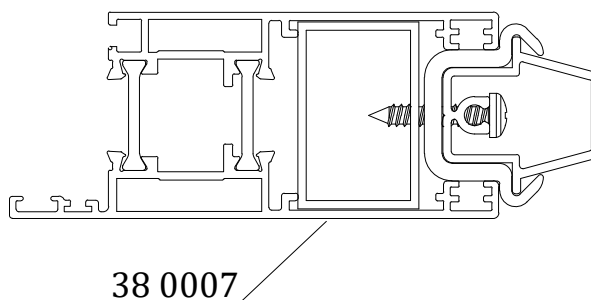
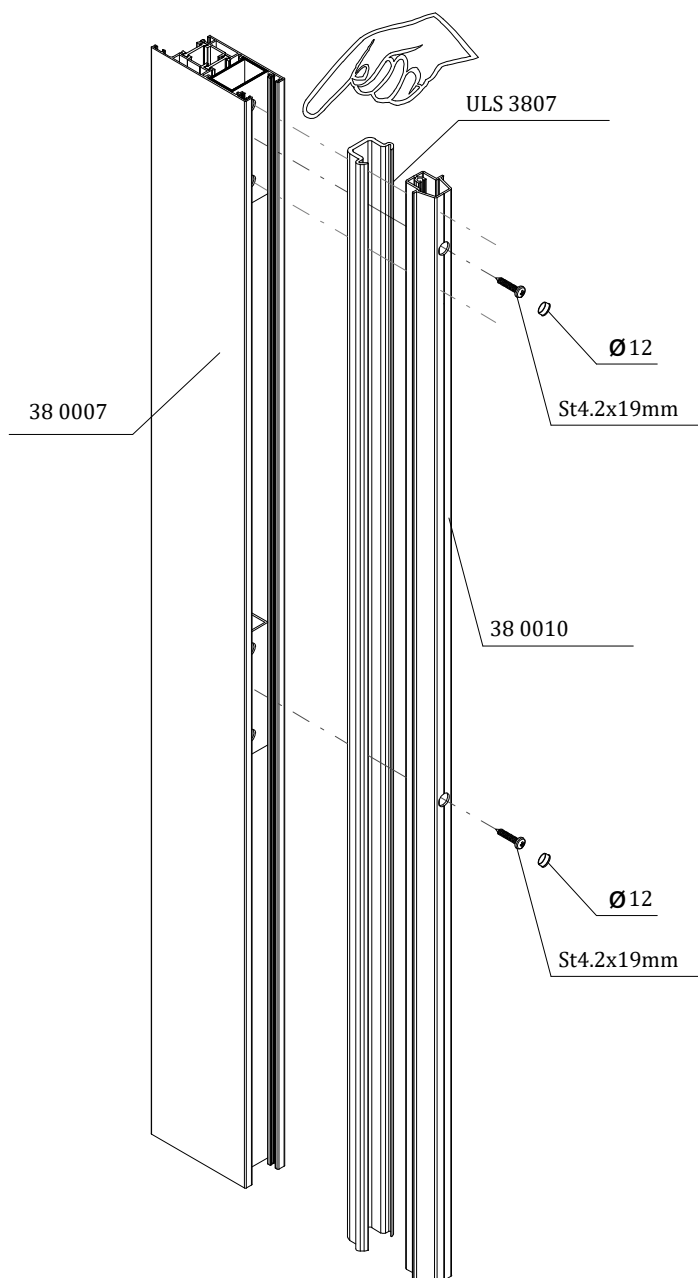

*Meeting stile profile
cap assembly*

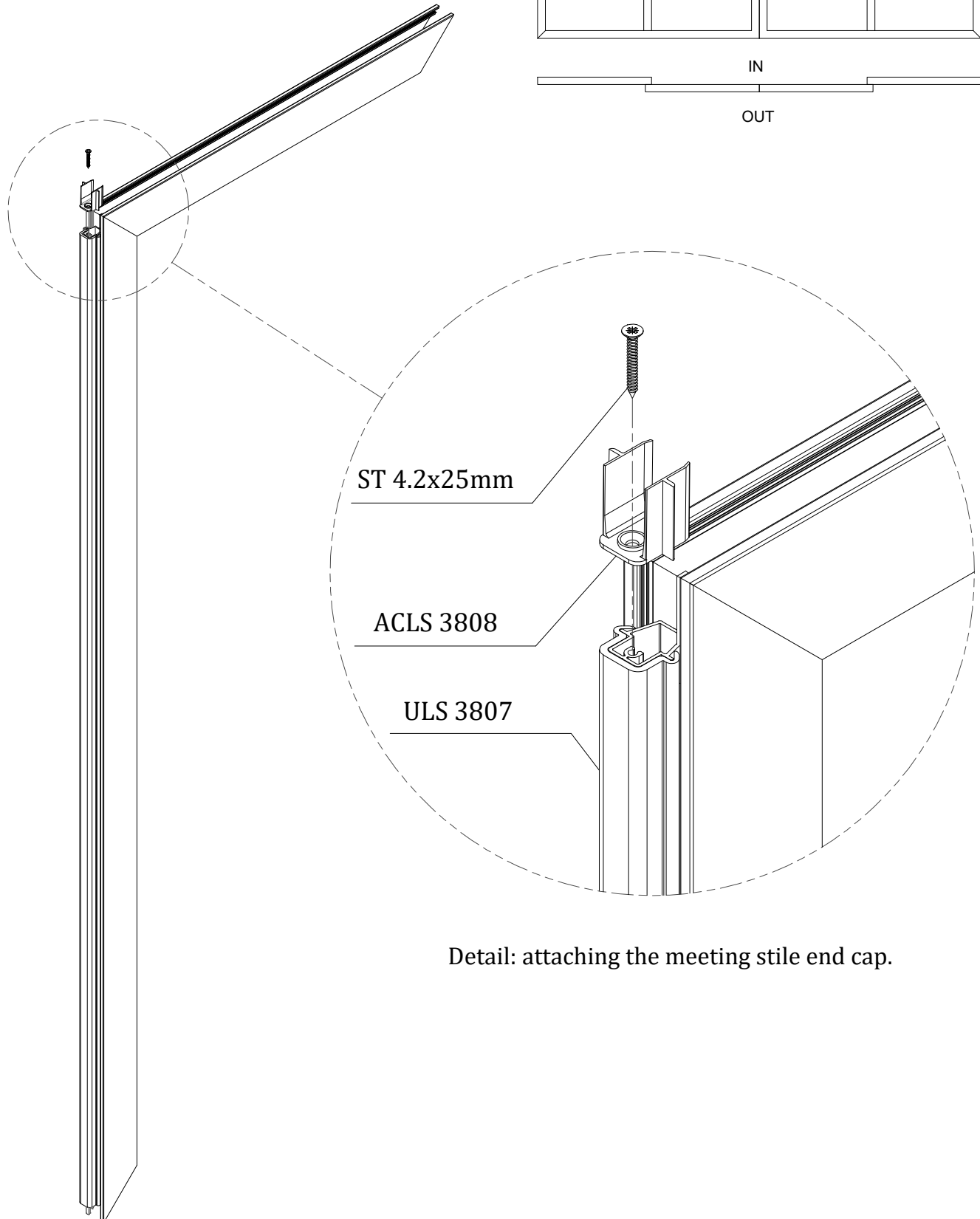
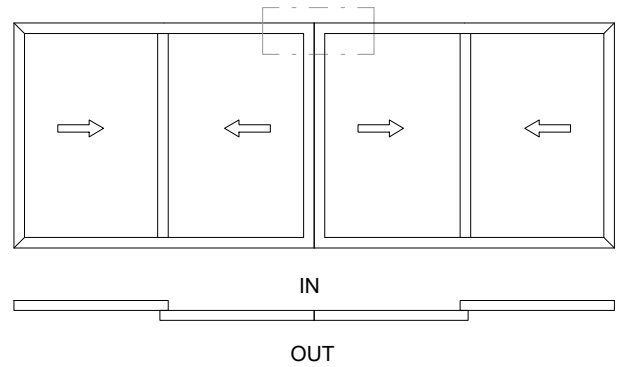

Detail: attaching the meeting stile end cap.

Installation bumper

STEP 1

We slide on vertical members of the sash the sock absorber as shown.

Attention : We screw the bolt until its final position, before we slide it on the sash as per previous note.

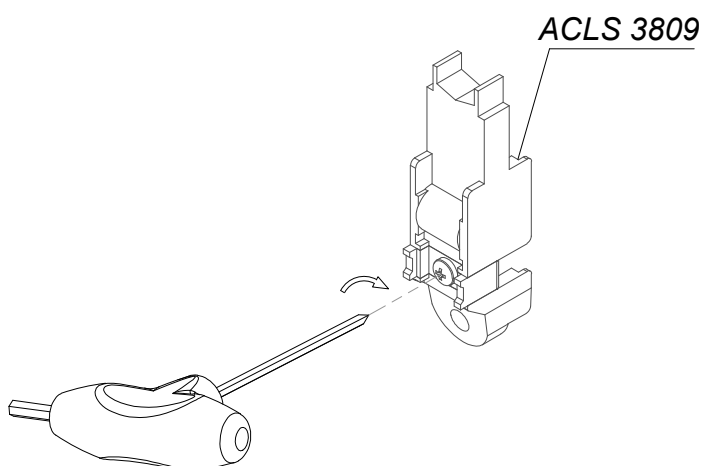
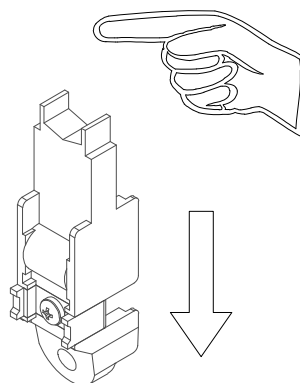

ACLS 3809

38 0007
(side sash)

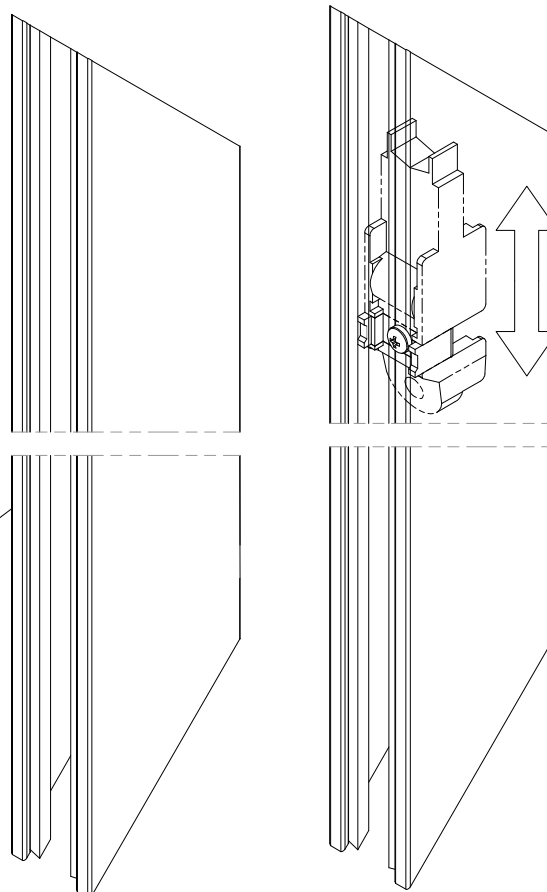

TOP VIEW

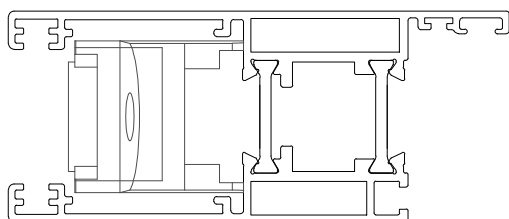

Installation bumper

STEP 2

After we load the sash on the frame, we unscrew the bolt in order to fix the sock absorber on its final position.

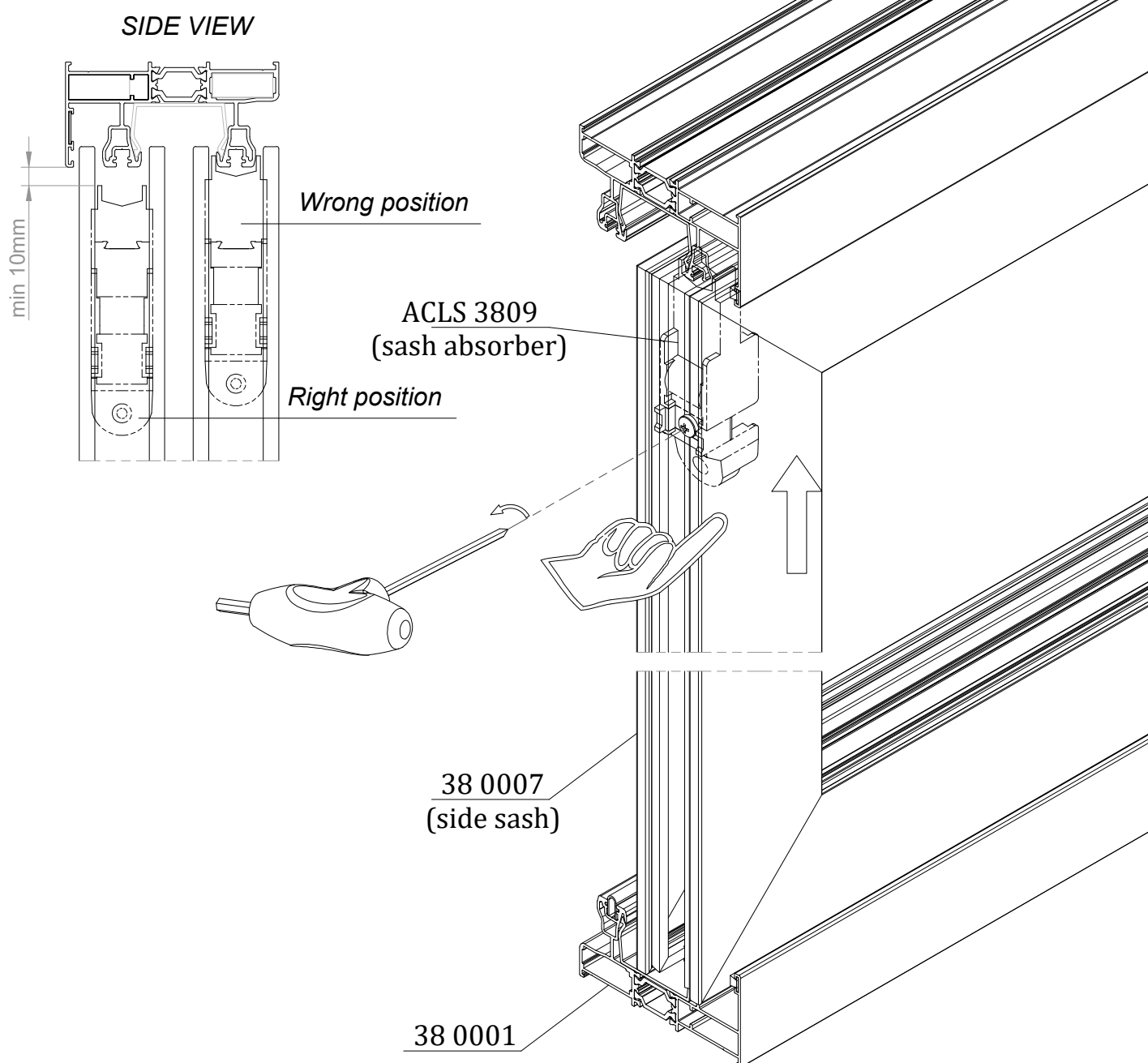

Mechanism assembly lift & slide (GU-937)

STEP 1

We attach the plastic spacer (GUL14-9-47296-38-0-6) on the lock before we screw it on the sash.

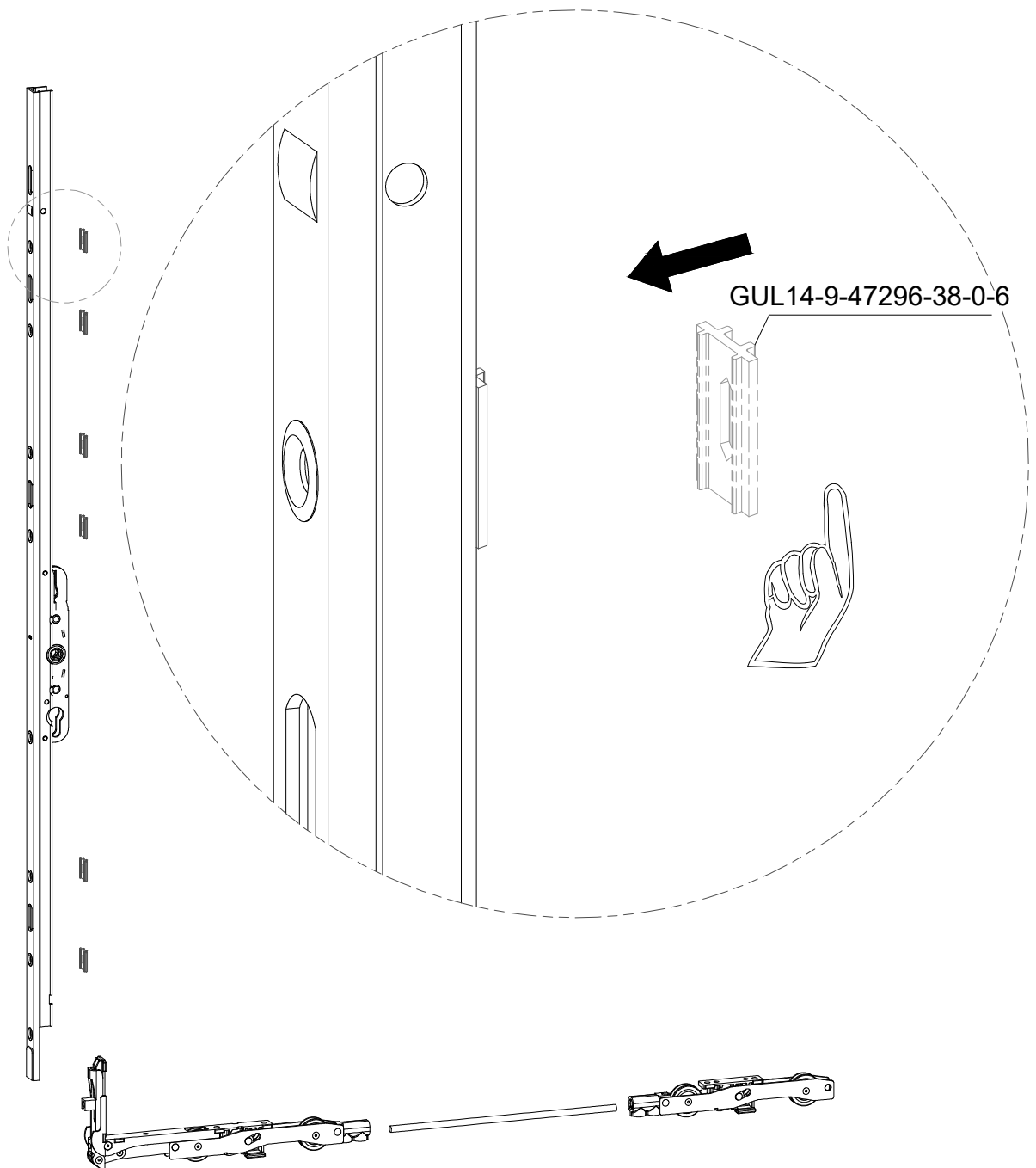

Mechanism assembly lift & slide (GU-937)

STEP 2

We screw the lock assembly according to machining of the sash.

Attention : We screw only the lateral member of the L&S mechanism.

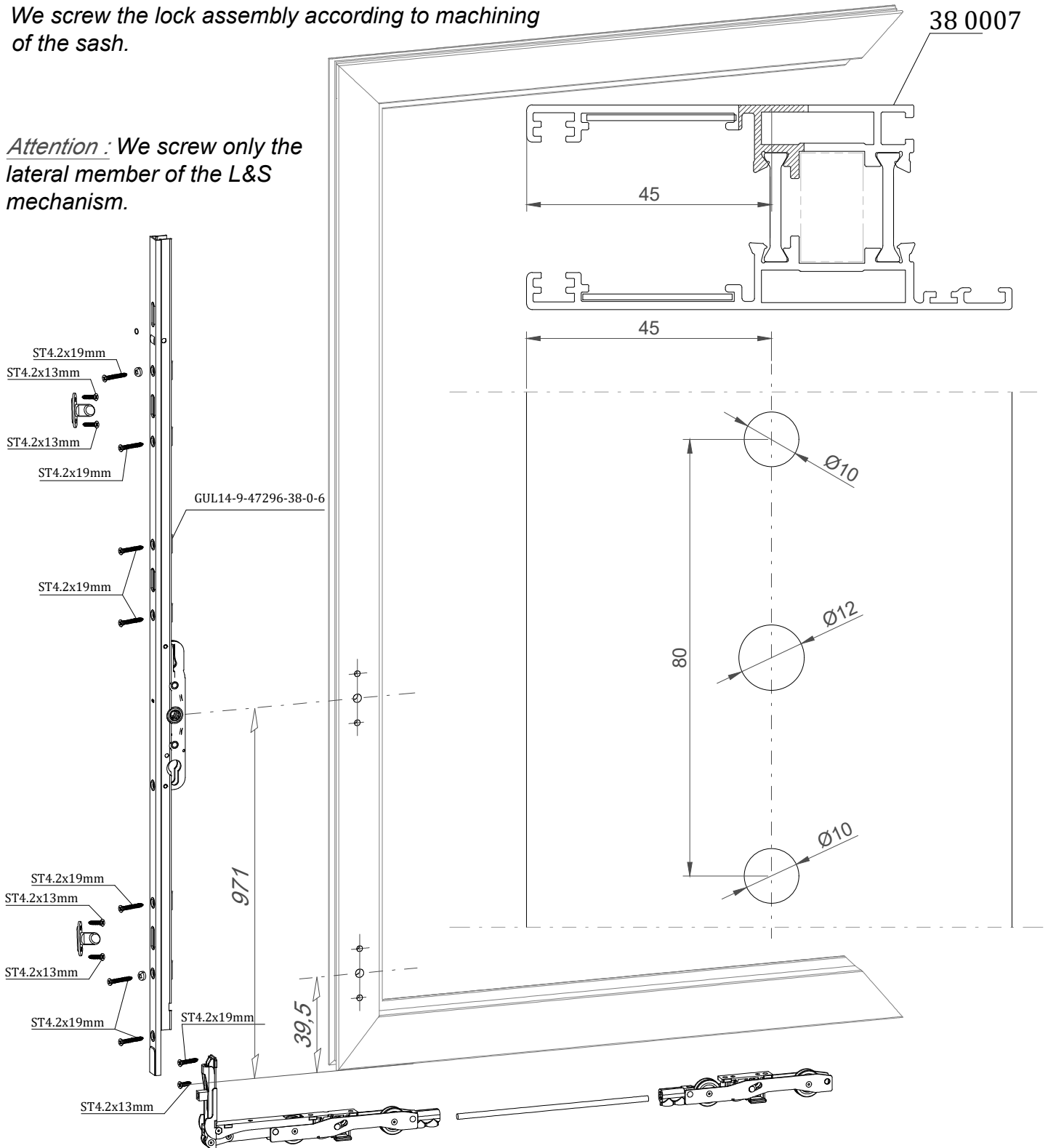

Mechanism assembly lift & slide (GU-937)

STEP 3

After the attachment of the L&S mechanism, before we screw the bottom member, we use the plastic guide spacer (GUL14-6-39690-38-0-0) to align the bottom member of the mechanism with the sash.

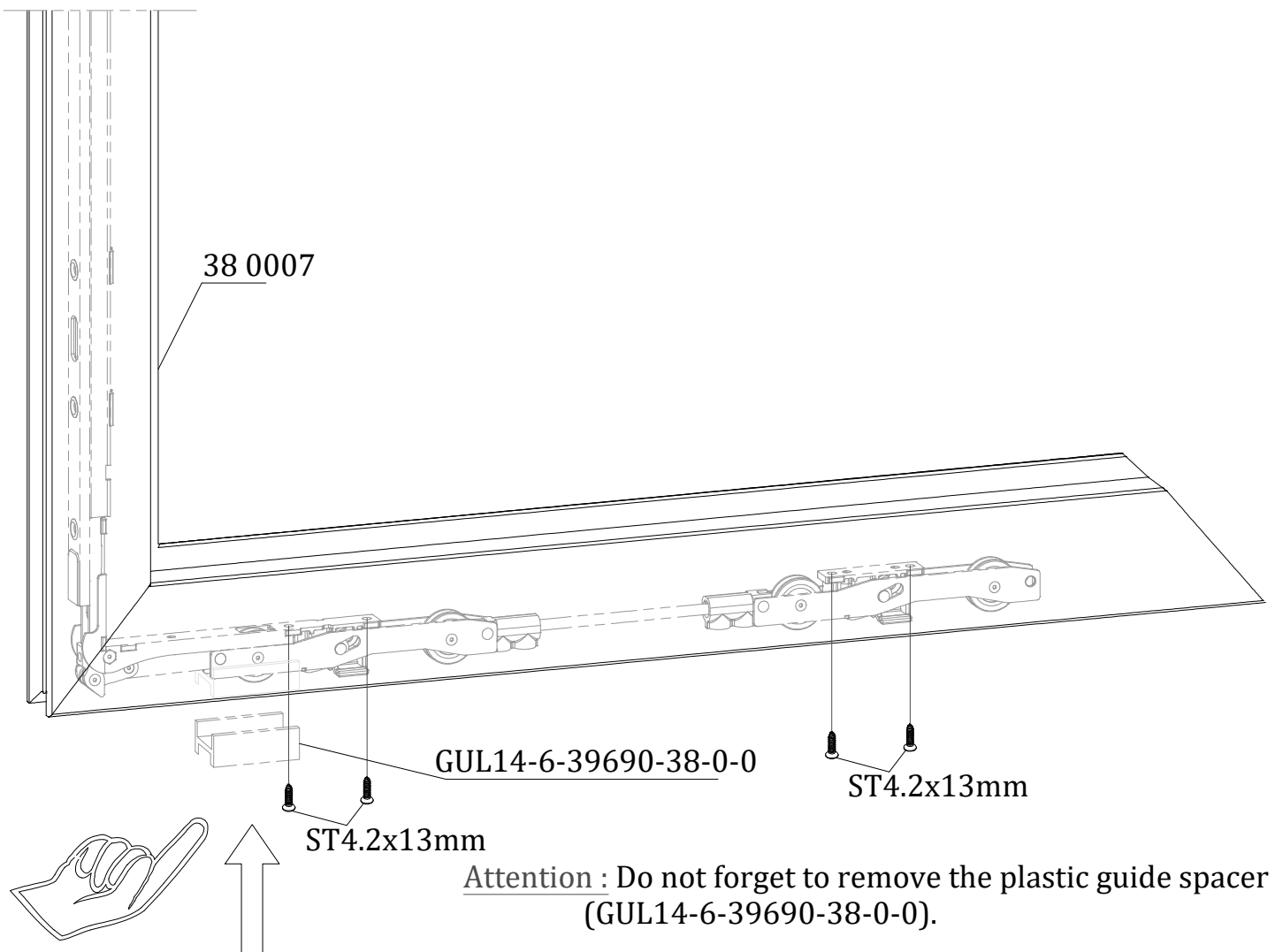

Subframe assembly

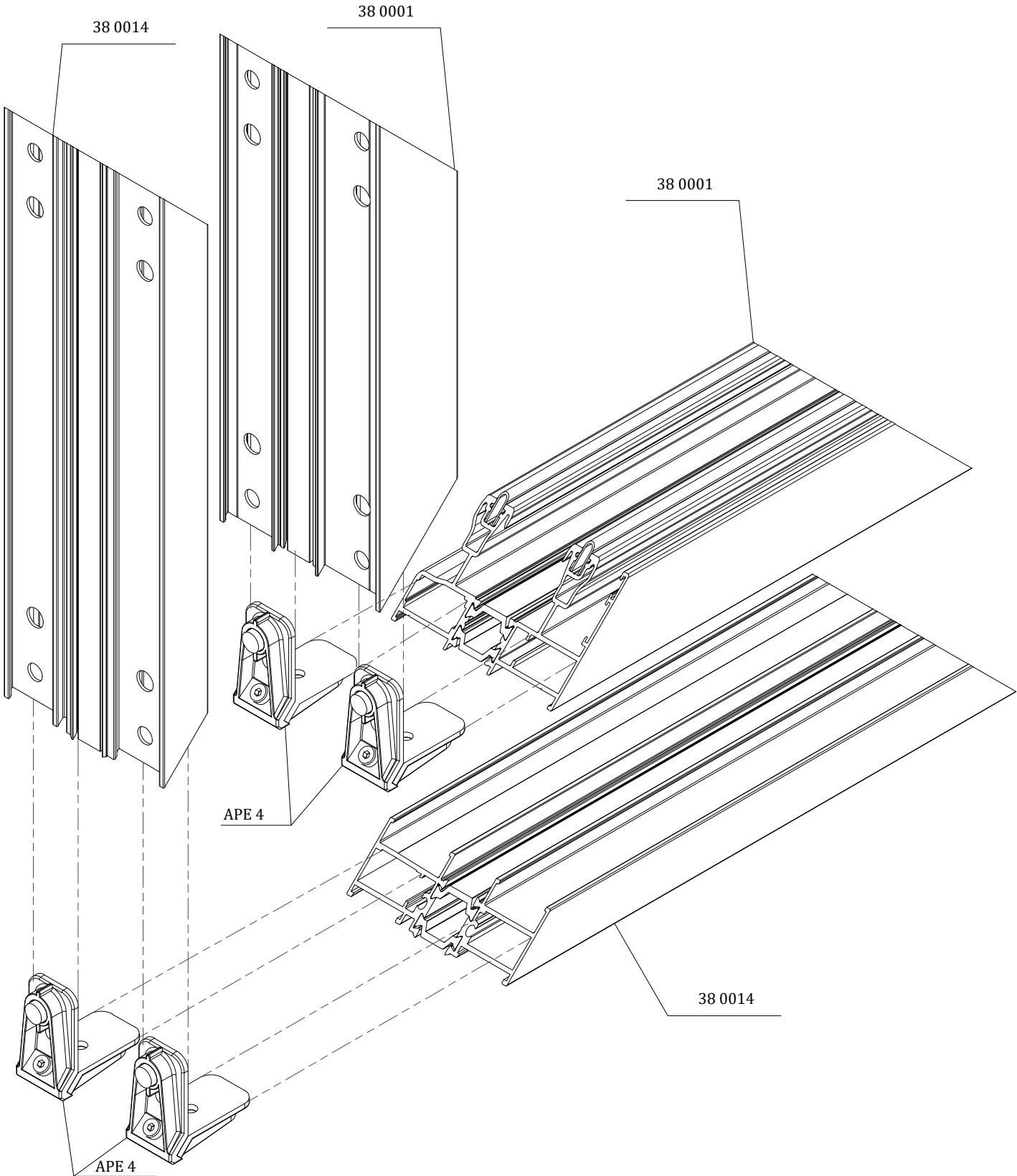

Subframe assembly

We can attach the frame on the subframe and fix with screws approximately every 300mm.

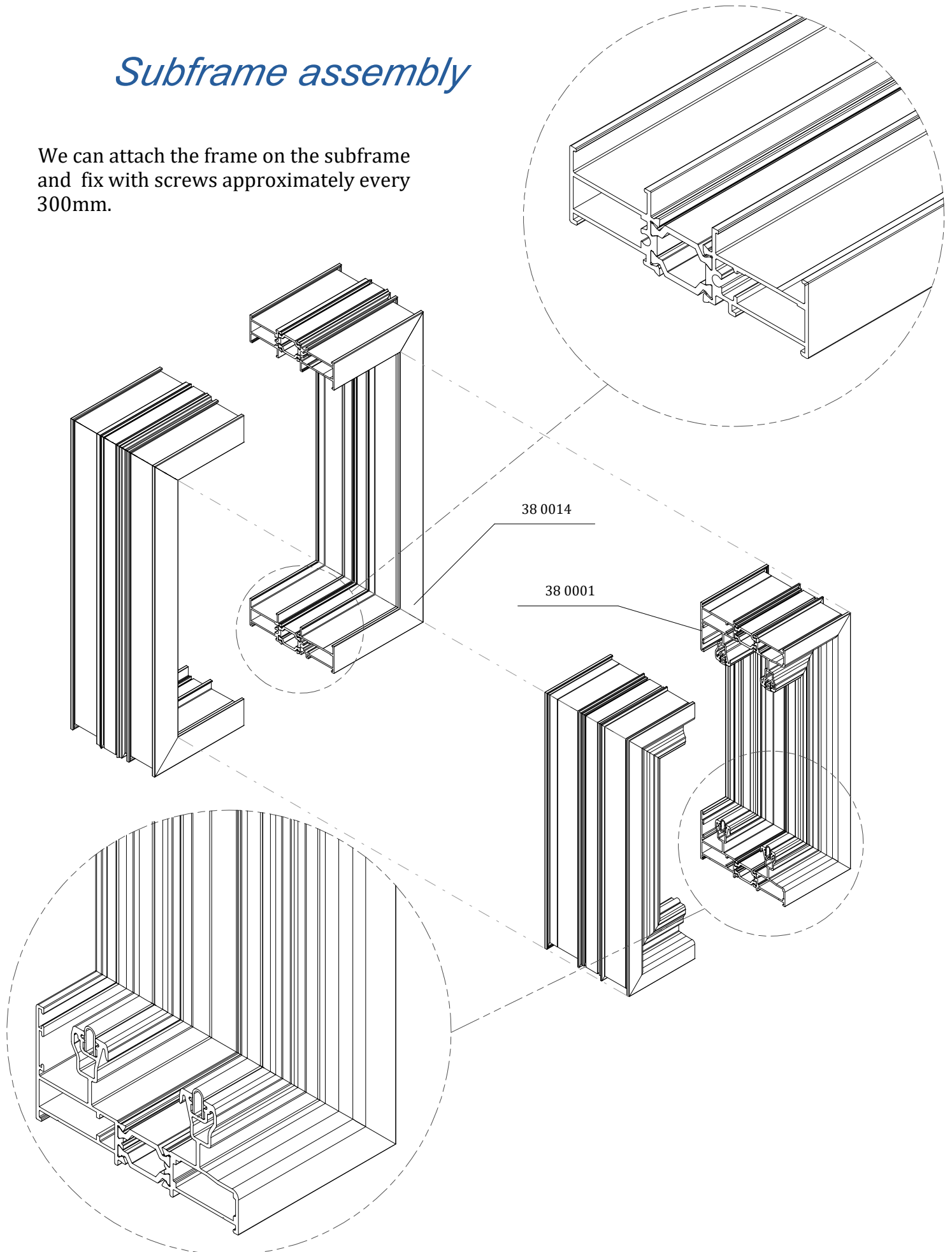

Subframe assembly

Alternatively when using only on the bottom side of frame, we should use end cap on both sides.

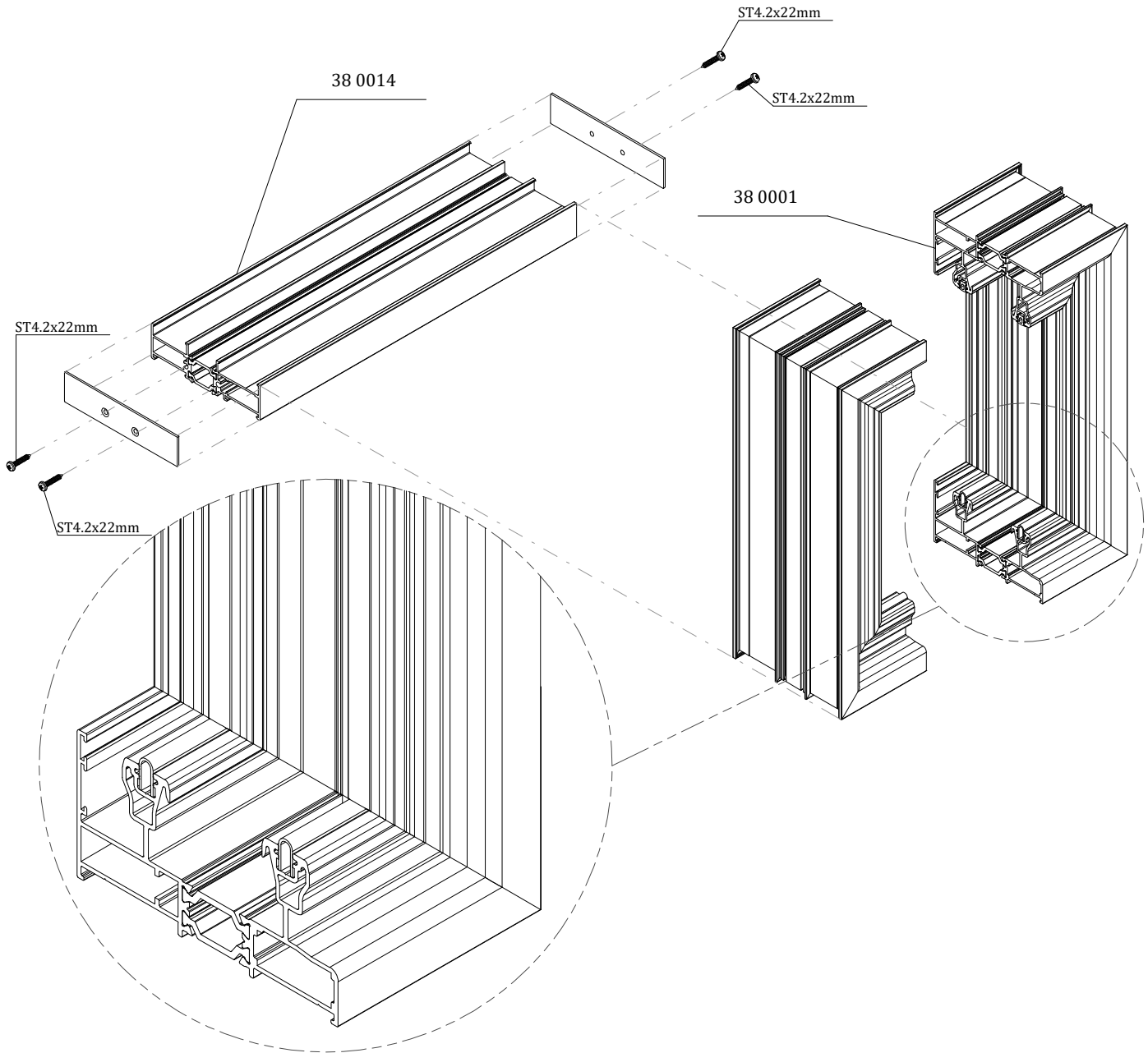



ALTEST[®]
Ltd.

**8000 Burgas
South Industrial Zone, Bulgaria**

**Tel: +359 56 880 440
Fax: +359 56 880 443**

office@altest-kmg.com

www.altest-kmg.com